

aerospace  
climate control  
electromechanical  
filtration  
fluid & gas handling  
hydraulics  
pneumatics  
process control  
sealing & shielding



# Fluid Power Seal Design Guide

Catalog EPS 5370



ENGINEERING YOUR SUCCESS.



**Failure, improper selection or improper use of the products and/or systems described herein or related items can cause death, personal injury or property damage.**

For safe and trouble-free use of these products, it is important that you read and follow the Parker Seal Group Product Safety Guide. This Safety Guide can be referenced and downloaded free of charge at [www.parkerseals.com](http://www.parkerseals.com) and can be ordered, without charge, as Parker Publication No. PSG 5004 by calling 1-800-C-PARKER.

This document, along with other information from Parker Hannifin Corporation, its subsidiaries and authorized distributors, provides product and/or system options for further investigation by users having technical expertise. It is important that you analyze all aspects of your application and review the information concerning the product or system in the current product catalog. Due to the variety of operating conditions and applications for these products or systems, the user, through his or her own analysis and testing, is solely responsible for making the final selection of the products and systems and assuring that all performance, safety and warning requirements of the application are met. The products described herein, including without limitation, product features, specifications, designs, availability and pricing, are subject to change by Parker Hannifin Corporation and its subsidiaries at any time without notice.

#### **OFFER OF SALE**

The items described in this document are hereby offered for sale by Parker Hannifin Corporation, its subsidiaries and its authorized distributors. This offer and its acceptance are governed by the provisions stated on the separate page of this document entitled "Offer of Sale."

# Fluid Power Seal Design Guide Table of Contents

## **Introduction**

1

## **Engineering**

2

## **Materials**

3

## **Fluid Power Applications**

4

## **Rod Seals**

5

## **Symmetrical Seals**

6

## **Piston Seals**

7

## **Wipers**

8

## **Wear Rings / Bearings**

9

## **Back-ups**

10

## **Urethane O-Rings / Head Seals**

11

See Appendices A through G for:

- A Design Action Request Form
- B English / Metric Conversions
- C Custom Groove Calculations
- D Chemical Compatibility
- E ASTM D2000 Compatibility
- F ISO Gland Tolerances
- G Other Parker EPS Products



**Parker Hannifin Corporation**  
Engineered Polymer Systems Division  
Phone: 801 972 3000  
Fax: 801 973 4019

[www.parkerseals.com](http://www.parkerseals.com)

# Introduction

Catalog EPS 5370/USA

***Parker Hannifin is the industry leader for sealing system solutions for the fluid power industry.***



## Rod Seals

Rod Seals, which guard against external leakage, are one of the most vital components of the sealing system. In recognition of their critical nature, Parker is pleased to offer the most complete range of materials and profiles in the industry. Our advanced plastic, rubber and PTFE material development delivers the highest performance in a wide variety of rod seal applications. Cutting edge technologies include multiple sealing lip systems, shock-load resistance, low friction and ultra-dry capability.

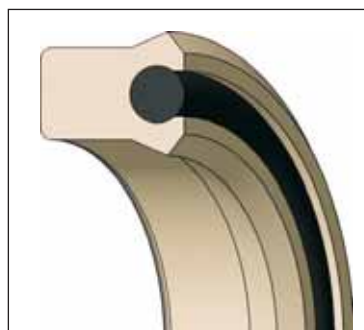

## Symmetrical Seals

With thousands of available size and material combinations, Parker symmetrical profiles are designed to act as either rod or piston seals, allowing one part number to function in two applications. Often copied but never equaled, the PolyPak™ for hydraulic applications and the 8400 u-cup for pneumatic applications have revolutionized the fluid power industry and become trusted standards. Symmetrical u-cups and squeeze seals are available in a variety of lip shapes and materials.

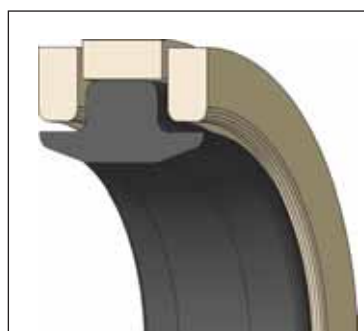

## Piston Seals

Our diverse product line of piston seal profiles suits a broad range of hydraulic and pneumatic applications. Whatever the need, from low pneumatic pressures to extreme hydraulic shock loading, Parker has the solution. Profiles are available to meet the demands of uni-directional and bi-directional pressure, low friction, easy installation, port passing, and zero-drift scenarios.

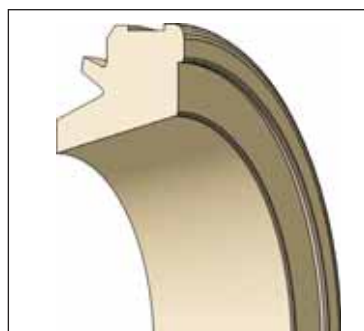

## Wipers

Just as rod seals are designed to keep fluid in, Parker wipers perform to keep contamination out. Wipers work in conjunction with rod seals to form the first line of defense in protecting a system and keeping it free from dirt, mud, water, and other contaminants. Incorporating the latest technology in aggressive wiping lips and OD exclusion, Parker has solutions in press-in, snap-in, and double lip profiles.

09/01/07

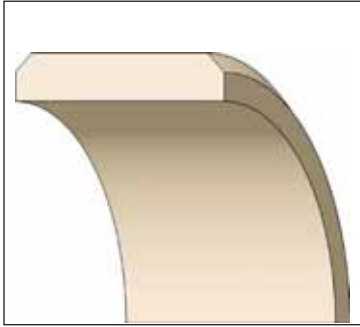

## Wear Rings and Bearings

Parker offers a complete line of wear rings and bearing products to fit any application. The product offering meets the full spectrum of needs, from heavy duty hydraulic cylinders operating under the highest temperatures and pressures to pneumatic applications requiring low friction, long life and self-lubrication. No matter what the application demands, Parker's diverse bearing product line ensures that performance requirements are met with maximized value.

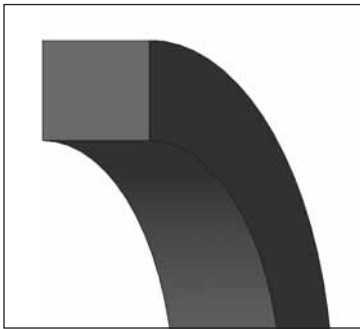

## Back-up Rings



















































Parker back-up rings offer simple solutions to safely increase system pressure or solve an existing seal extrusion problem. Standard profiles are available in a variety of materials to complement virtually any Parker rod or piston profile.



## O-rings & Head Seals

Parker is pleased to offer the material advantages of the Resilon™ family of urethanes in standard and custom o-ring sizes. With high temperature Resilon o-rings, the need for back-ups can be eliminated, simplifying installation and reducing damage due to spiral failure. Static head seals are ideal for replacing o-rings and back-ups in hydraulic cylinder heads, fool-proofing installation and eliminating failures due to back-up pinching and blow-out.





























## Rod Seals (See Section 5)

Profile	Description	Application (Duty)				Page
		Hydraulic			Pneumatic	
		Light	Medium	Heavy		
BD	 Premium non-symmetrical o-ring energized rod seal with a knife trimmed primary lip and molded secondary lip. Standard materials are 4300, 4700, 5065. Available with positively actuated back-up.					5-5
BT	 Premium non-symmetrical u-cup rod seal with a knife trimmed primary lip and molded secondary lip. Standard material is 4300 family.					5-7
BS	 Non-symmetrical u-cup rod seal with knife trimmed primary lip and molded secondary lip. Standard materials are 4300 family, 4700, 5065.					5-9
B3	 Non-symmetrical u-cup with knife trimmed lip. Standard materials include 4300, 4700, 5065.					5-11
UR	 Standard non-symmetrical u-cup with trimmed lip. Standard material is 4615.					5-13
E5	 Non-symmetrical low friction rounded lip pneumatic rod seal. Standard materials include 4274, 4180, 4208, 5065.					5-21
TR	 Bi-directional rod "T-seal" available in no back-up, single back-up, and two back-up groove sizes. Standard energizer materials include 4111, 4274, 4205, 4259. Back-ups available in PTFE, Nylon, PEEK.					5-24
ON	 Bi-directional, rubber energized PTFE rod cap seal. Full range of energizer and PTFE materials available.					5-28
CR	 Bi-directional, low profile, rubber energized PTFE cap rod seal designed to fit standard o-ring glands. Full range of energizer and PTFE materials available.					5-32
OC	 Standard bi-directional rubber energized PTFE rectangular cap rod seal. Full range of energizer and PTFE materials available.					5-39
BR	 Premium knife trimmed buffer or secondary seal designed to work with a primary rod seal for heavy duty or zero-leak systems. Standard material is 4300.					5-45
OD	 Uni-directional rubber energized PTFE rod seal, typically used as a buffer or secondary rod seal. Full range of energizer and PTFE materials available.					5-48
V6	 Pneumatic cushion or check valve rod seal used to cushion the piston using internal pressure. Standard materials include 4622, 4180, 4181, 4208.					5-54
OR	 Bi-directional rubber energized PTFE rod seal used in rotary or oscillating applications. Full range of energizer and PTFE materials available.					5-57













09/01/07



## Symmetrical Seals for Rod or Piston Applications (See Section 6)













































Profile	Description	Application (Duty)				Page
		Hydraulic			Pneumatic	
		Light	Medium	Heavy		
SPP	 Standard PolyPak. A square shaped symmetrical squeeze seal with a knife trimmed scraper lip. Standard materials include 4615, 4622, 4651, 4263, 4207, 4266.					6-6
DPP	 Deep PolyPak. A rectangular shaped symmetrical squeeze seal with a knife trimmed scraper lip. Standard materials include 4615, 4622, 4651, 4263, 4207, 4266.					6-8
BPP	 Type B PolyPak. A rectangular shaped symmetrical squeeze seal with a knife trimmed beveled lip. Standard materials include 4615, 4622, 4651, 4263, 4207, 4266.					6-10
SL	 A dual lip seal created by the combination of a standard PolyPak square shell and a rubber lip seal/energizer. Standard materials are a 4615 shell and 4180 lip seal/energizer. Also known as SCL-Pak.					6-39
US	 Standard symmetrical u-cup with trimmed beveled lips. Standard material is 4615.					6-42
8400 8500	 Symmetrical rubber u-cups used primarily in pneumatic applications. 8400 series feature knife trimmed with a beveled lip. 8500 series feature a scraper lip. Standard materials include 4180, 4274, 4208.					6-49
AN 6226	 Industry standard symmetrical u-cups per the old Army Navy (AN) specification. Standard material is 4295.					6-55
SPI- RAL VEE	 Spiral v-packing rings typically sold in sets, also known as chevron packing. Made from a wide range of materials, v-packing may be cut to size, machined, or net molded. Most dynamic v-packing has been replaced with PolyPak seals or u-cups.					6-59

## Piston Seals (See Section 7)

BP	 Premium bi-directional rubber energized urethane piston cap seal. Standard material is 4304.					7-5
PSP	 Standard bi-directional rubber energized urethane piston cap seal. Standard materials include 4300, 4622.					7-8
CC	 ChemCast is a heavy duty bi-directional rubber energized hard plastic, step-cut piston cap seal.					7-11
OK	 Bi-directional rubber energized nylon step-cut piston cap seal.					7-13
PIP	 Bi-directional piston seal created by the combination of a Pressure Inverting Pedestal (PIP) back-up ring and Type B PolyPak. Standard material is a 4615 PolyPak with a 4617 PIP ring.					7-15

09/01/07











































## Piston Seals (See Section 7)

Profile	Description	Application (Duty)				Page
		Hydraulic			Pneumatic	
		Light	Medium	Heavy		
B7	 Premium non-symmetrical u-cup with knife trimmed lip piston seal. Standard materials include 4300, 4700, 5065.					7-19
UP	 Standard non-symmetrical u-cup with trimmed beveled lip piston seal. Standard material is 4615.					7-23
E4	 Non-symmetrical low friction rounded lip pneumatic piston seal. Standard materials include 4274, 4180, 4208, 5065.					7-26
BMP	 Low friction bumper and round lip seal profile for use in pneumatic applications. Standard materials include 4274 and 4208.					7-29
TP	 Bi-directional piston "T-seal" available in no back-up, single back-up, and two back-up grooves. Standard energizer materials include 4111, 4274, 4205, 4259. Back-ups available in PTFE, Nylon, PEEK.					7-31
S5	 Economical medium duty bi-directional o-ring energized PTFE piston seal. Standard material is 15% fiberglass-filled PTFE with nitrile energizer. Split option available.					7-35
R5	 Medium to heavy duty bi-directional lathe cut energized PTFE piston seal. Full range of energizer and PTFE materials available. Split option available.					7-39
CT	 Four piece capped "T-seal" piston seal made from molded rubber energizer, PTFE cap, and Nylatron back-ups.					7-43
CQ	 Bi-directional three piece lathe cut energized PTFE cap piston seal with an integrated quad seal for zero drift. Also available with dual o-ring energizer.					7-48
OE	 Bi-directional, rubber energized PTFE piston cap seal. Full range of energizer and PTFE materials available.					7-53
CP	 Bi-directional low profile, rubber energized PTFE cap piston seal designed to fit standard o-ring glands. Full range of energizer and PTFE materials available.					7-62
OA	 Standard bi-directional rubber energized PTFE rectangular cap piston seal. Full range of energizer and PTFE materials available.					7-68
OQ	 Bi-directional rubber energized PTFE piston seal used in rotary or oscillating applications. Full range of energizer and PTFE materials available.					7-74

09/01/07





















## Wipers (See Section 8)

















Profile	Description	Application (Duty)				Page
		Hydraulic			Pneumatic	
		Light	Medium	Heavy		
YD	 Premium snap-in wiper with OD exclusion lip and a knife trimmed wiping lip. Standard material is 4300.					8-5
SHD	 Slotted heel snap-in wiper for pneumatics and light to medium duty hydraulics. Standard materials are 4615, 5065, 4263, 4208, 4207.					8-6
SHX	 Slotted heel snap-in wiper with OD exclusion feature. Designed to upgrade SHD wipers without changing the groove. Standard materials are 4615, 5065.					8-7
SH959	 An industry standard slotted heel Army Navy (AN) wiper designed to fit MS-28776 (MS-33675) grooves. Standard materials are 4615, 5065, 4263, 4208, 4207.					8-11
SX959	 An industry standard slotted heel Army Navy (AN) wiper with an OD exclusion feature designed to fit MS-28776 (MS-33675) grooves. Designed to upgrade SH959 wipers without changing the groove. Standard materials are 4615, 5065, 4263, 4208, 4207.					8-12
AH	 Double-lip, press in place, metal canned wiper with knife trimmed sealing lip for heavy duty hydraulics. Standard materials are 4300, 4700, 4615.					8-15
J	 Standard single-lip, press in place, metal canned wiper with a knife trimmed lip for medium and heavy duty hydraulics. Standard materials are 4300, 4700, 4615.					8-17
AY	 Premium snap-in place double-lip wiper for hydraulic applications. Standard materials are 4300, 4301, 4700.					8-19
H / 8600	 Standard snap-in place double-lip wiper. Standard materials for H wiper are 4615, 5065. Standard material for 8600 wiper is 4181.					8-21
K	 Light load snap-in wiper with double-lip designed for low friction, light load applications. Standard material is 4615.					8-27
AD	 Double acting, double-lip, rubber energized PTFE wiper. Full range of energizer and PTFE materials available.					8-30
SG	 Metal scraper with rubber energizer for excluding abrasive contaminants.					8-36

09/01/07











## Wear Rings / Bearings (See Section 9)

Profile	Description	Application (Duty)				Page
		Hydraulic			Pneumatic	
		Light	Medium	Heavy		
WPT	 Tight tolerance piston wear ring with chamfered corners. Standard material is 4733 WearGard™.					9-7
WRT	 Tight tolerance rod wear ring with chamfered corners. Standard material is 4733 WearGard.					9-11
WN	 Standard commercial wear ring for rod and piston applications. Standard material is 4650 MolyGard™.					9-14
PDT	 PTFE wear strip/bearing available cut to length or in bulk rolls. A variety of PTFE compounds are available.					9-18
PDW	 Precision cut wear ring/bearing machined from PTFE billet material. Rod and piston chamfer may apply.					9-27

## Back-ups (See Section 10)

MB	 Heavy cross-section modular back-up for PolyPak seals. Standard materials are 4617, 4652.					10-4
8700	 Light cross-section back-up for PolyPak and u-cup seals. Standard materials are 4651, 4729.					10-10
5100	 Back-up rings designed for o-ring grooves. Standard materials are 4651, 4729.					10-13
PAB	 Positively actuated back-up ring incorporated into common seal profiles to extend a seal's pressure range. Sold as an assembly with the seal.					10-21
PDB	 Anti-extrusion PTFE ring offered in solid and split configurations. Full PTFE material range applies.					10-22





## Urethane O-Rings & Head Seals (See Section 11)

568	 High performance urethane o-ring made from the Resilon™ family of high temperature, low compression set urethanes.					11-2
HS	 Static head seals designed to replace o-rings and back-up in static applications. Standard material is 4700.					11-15

## General Application Guidelines

Parker's selection of products is the broadest offering in the industry for hydraulic and pneumatic sealing systems. Table 1-1 provides "General Application Guidelines" to help define possible differences between light, medium and heavy duty applications. The product profile charts beginning on page 1-4 show corresponding application duty recommendations for each profile.

Table 1-1. General application guidelines.

Application Parameter	Hydraulic			Pneumatic	
	 Light Duty	 Medium Duty	 Heavy Duty	 Light Duty	 Heavy Duty
Pressure Range	<1200 psi (<83 bars)	<3500 psi (<241 bars)	>3500 psi (>241 bars)	1 to 200 psi (0 to 14 bar)	Above 200 psi (Above 14 bars)
Pressure Spikes	None or low	Not to exceed twice the system pressure. Short duration such as valve shifting.	Pressure spikes that may be several times the system pressure and of a longer duration. These are often mechanically induced by forcing the rod in or out.	Because of the compressive nature of gases pressure spikes are typically not a problem.	Because of the compressive nature of gases pressure spikes are typically not a problem.
Temperature Range	0°F to 160°F (-18°C to 71°C)	-20°F to 200°F (-29°C to 93°C)	-45°F to 225°F (-43°C TO 107°C)	0°F to 72°F (-18°C to 22°)	Cryogenic to 450°F (232°C)
Contamination	Low or non existing	Moderate with cylinder in horizontal or inverted position.	Moderate to high with the cylinder upright - vertical	Low or non existing	Moderate to high with the cylinder upright - vertical
Side Loading	None to light with shorter stroke and vertical cylinder mount.	Moderate side load with cylinder mounted towards the vertical position. Medium stroke.	Longer stroke lengths. Cylinder mounted horizontal, heavy side loading.	None to light with shorter stroke and cylinder mount vertical.	Longer stroke lengths. Cylinder mounted horizontal, heavy side loading.

It is not uncommon for the requirements of a sealing system to fall into multiple duty columns. When this situation occurs you should select the majority of your components from the lesser duty range.

When selecting a wiper, focus on contamination section.

In selecting a sealing component you will evaluate the temperature, pressure and pressure spike variables of the application. With a wear ring, you will want to look at the temperature and side loading section. This does not preclude the need to consider such things as fluid being sealed and stroke speed.

## The Parker Advantage

Parker is the world's leading diversified manufacturer of motion and control technologies and systems, providing precision-engineered solutions for a wide variety of commercial, mobile, industrial and aerospace markets. The Engineered Polymer Systems (EPS) Division of Parker Seal Group, has over 40 years experience designing and manufacturing elastomeric, polymeric and plastic seals, materials, and sealing systems for dynamic applications. Working with Parker EPS Division gives you access to all of Parker's Seal Group in North America, Europe, and Asia.

## Worldwide Manufacturing

Parker Seal Group and EPS Division's manufacturing facilities for dynamic seals include:

### North America:

#### EPS Division Salt Lake City

Division Headquarters  
Plastic & Rubber Operations  
2220 South 3600 West  
Salt Lake City, UT 84119

#### EPS Division Nacogdoches

Clipper Operations  
Oilfield Rubber Operations  
Expansion Joint Operations  
403 Industrial Blvd.  
Nacogdoches, TX 75964  
Ph: (800) 233-3900

#### EPS Division PTFE Operations:

EPS Division, Elgin Operations  
2565 Northwest Parkway  
Elgin, IL 60124  
Ph: (847) 783-4300

EPS Division, Marion Operations  
3967 Buffalo Street  
Marion, NY 14505  
Ph: (315) 926-4211

EPS Division, Baja Operations  
Baja, Mexico  
Ph: (619) 671-3257



*EPS Division Salt Lake City Operations*



*EPS Division Chicago (Elgin)*



*EPS Division Nacogdoches*



*EPS Division Marion*



*EPS Division Baja*

09/01/07

**Europe:****Packing Operations:**

Prädifa, Stuttgart, Germany  
Ph: (+49) 7142 351-0

**PTFE Operations:**

Polar Seals ApS, Espergaerde, Denmark  
Ph: (+45) 49 121700

Advanced Products NV, Boom, Belgium  
Ph: (+32) 3 880 81 50

Sadska, Czech Republic  
Ph: (+420) 325 555 111

**Asia:**

Parker Hannifin Motion & Control Co., Ltd.  
Shanghai, China  
Ph: (+86) 21 28995181

*Bietigheim**Denmark**Belgium**Czech Republic*



## Manufacturing Excellence

Parker's manufacturing capabilities accommodate a wide range of dynamic sealing needs, providing the following value benefits to our customers:

- All manufacturing operations offer state of the art processes and procedures that enable Parker to provide world class products, in both standard and custom profiles.
- Specialized cellular manufacturing and lean concepts enable Parker to handle both low and high volume runs with equal efficiency.
- Breadth of tooling capability produces diameters as small as 1/16 inch and as large as 9 feet without splicing.
- Custom high speed trim machines ensure a sharp sealing edge for the ultimate seal performance wherever possible.

## Rubber Operations

With over 400 unique rubber compounds, Parker has the largest selection of materials available in the industry. Our material offering includes custom blends of nitrile, ethylene propylene and fluorocarbons, among others. If an application demands unique material specifications, our in-house chemists have the expertise and capability to assist in specifying and validating optimal materials to meet system requirements. State of the art rubber molding processes such as compression, transfer, injection and injection-compression are used to manufacture the highest quality products.



*Rubber Injection Press*

## Plastic Operations

Our plastics material offering includes such seal industry standards as Molythane™, PolyMyte™, WearGard™, MolyGard™, and many more. Parker's

Resilon™ family offers the highest temperature performance of any urethane in the industry. Our commitment to quality and research and development remains a top priority to ensure leading edge status in new material development. With in-house processing, from manufacturing the plastic pellet to molding the finished product, Parker maintains strict controls which ensure the delivery of quality products from quality materials — start to finish.



*Plastic Manufacturing*

## PTFE Operations

Parker's PTFE operations manufacture high quality machined seals from ¼ inch to 72 inches in diameter, utilizing virgin and proprietary blends of filled PTFE. A wide variety of PTFE fluid power seals are manufactured on state of the art CNC equipment with live tooling and multi-axis capabilities. Automated processing allows the efficient handling of both low and high volume runs. PTFE production at Parker is entirely an internal system, from material blending and molding to sintering and CNC machining. Our commitment to quality and service is supported by investment in advanced technology, test and inspection methods.



*PTFE Manufacturing*



## Applications Engineering

Our team of application engineers can help you find the most reliable, cost-effective sealing solution for your product. These engineers are experts, combining decades of sealing experience in real-world applications with a full complement of technology-driven tools to produce the answers you need.

## FEA

Utilizing advanced non-linear Finite Element Analysis (FEA) software our engineers can perform extremely accurate virtual simulations of material performance based on actual physical test data. These simulations eliminate the need for multiple iterations of costly prototype tooling, and dramatically reduce development lead times. They also ensure first-time selection of the best material and geometry for your application.

## Mechanical Test Lab

Parker's mechanical test lab is an important asset for validating new designs and qualifying seals to customers' performance specifications. Our sophisticated mechanical testing lab utilizes several breakthrough technologies, enabling engineers to validate seals and sealing systems for hydraulic, pneumatic and rotary systems. All product testing is carried out in accordance with ASTM and SAE specifications as well as customer-specific requirements.

Hydraulic testing capabilities include pressures up to 10,000 psi with environmental chambers to control temperatures from -40 to 300 °F. Tests can be performed on assembled cylinders or can be configured on test stands which isolate performance of rod seals, piston seals and wipers for troubleshooting and fine tuning. For heavy contamination situations, our dust chamber can be used to simulate the most rigorous operating environments, putting seals to the ultimate test.

Pneumatic testing is also environmentally controlled to simulate a variety of operating conditions. Endurance and life cycle tests can be performed on applications of all speeds and pressures, from automation and assembly cylinders to high speed pneumatic hand tools.

Rotary testing capabilities range from low speed, high pressure hydraulic swivels to high speed gear box and bearing applications in extreme operating conditions, validating seal performance across a wide range of industries.



*Low pressure life cycle testing*



*Pneumatic cylinder testing*



*High pressure hydraulic leakage testing*



*Rotary hydraulic testing*

09/01/07

## Premier Customer Support

Worldwide and local support is just a phone call away. Our local Parker sales representatives provide a single point of contact for local sealing support. Our established worldwide network of over 300 distributor and service center locations combined with factory direct representatives, including global sales and engineering, ensures access to quality products and engineering services anytime, anywhere.

Customer service is a key component of the Parker package. Electronic ordering systems such as EDI and PHconnect make placing and tracking orders easy. Our knowledgeable customer service representatives are only a phone call away at 801 972 3000.



*SmartScope™ inspection*

## Quality Commitment

Parker is committed to consistently delivering excellence in quality and service through continuous improvement of our people, products and systems. Our manufacturing facilities are registered to either AS9100, ISO/9000, or TS16949 standards.

Our commitment to quality and service is supported by our investment in advanced test and inspection methods and equipment. Parker constantly strives to improve customer satisfaction and product quality through the implementation of:

- Six Sigma
- Lean manufacturing
- Kaizen events
- TQM
- Advanced product quality planning (APQP)
- Feasibility studies



*CMM: Coordinate measuring tool inspection*

Parker is consistently willing to explore new ideas with the companies and individuals we serve. Customers come to Parker for different reasons, but our role is always the same . . . working to use our expertise and help our customers engineer their success.

## Contents

- Sealing Theory ..... 2-1
  - Static vs. Dynamic Sealing .... 2-1
  - Leakage Control ..... 2-2
  - Lip vs. Squeeze Seals ..... 2-2
  - Effects of Lip Geometries ..... 2-3
  - Friction..... 2-3
  - Pressure Effects & Extrusion... 2-4
  - Seal Wear ..... 2-5
  - Seal Stability..... 2-6
  - Surface Speed..... 2-6
  - Compression Set..... 2-7
  - Influence of Temperature ..... 2-7
- General Guidelines for Hardware Design ..... 2-8
- Hardware Surface Finish
  - Surface Finish Guidelines ..... 2-9
  - Surface Finish FAQs..... 2-13
- Installation
  - Considerations ..... 2-14
  - Installation Tools - Piston..... 2-16
  - Installation Tools - Rod ..... 2-17
- Finite Element Analysis ..... 2-18

## Parker fluid power seals for all application technologies

Seals have been used since ancient times and have evolved into a wide variety of shapes and materials. For those who are not familiar with sealing technology, the number of options available can be confusing. Selecting the most suitable product for a given application can be difficult. This engineering section will assist in product selection by explaining the fundamentals of seal design and material technology.

### Sealing Theory

#### Static vs. Dynamic Sealing

Every seal, whether static or dynamic, must seal against at least two contacting surfaces. In static applications, both surfaces are non-moving relative to one another. In dynamic applications at least one surface is in motion relative to the other sealing surface(s). For example, in a standard hydraulic cylinder, the rod and piston seals would be classified as dynamic seals, while the seal between the bore and the head gland would be considered a static seal.

In both static and dynamic applications, a certain amount of squeeze or compression is required upon installation to maintain contact with the sealing surfaces and prevent fluid leakage. Dynamic applications in particular involve other variables and require that additional factors be evaluated to ensure proper system performance. These variables are discussed in the following sections.



Fig. 2-1. Hydraulic cylinder

## Leakage Control

2

When choosing a sealing system, the desired result is ultimately leakage control. Seal design and material improvements have made it possible not only to have seal combinations that provide zero leakage, but also provide extended life in a variety of applications. Aside from the seals themselves, a thorough understanding of system parameters is necessary to obtain the best results.

Optimal sealing is best achieved by taking a systems approach to the seal package rather than considering components individually. Our profiles have been designed specifically to complement one another to create high performance systems. For example, pairing a Parker rod seal with a Parker wiper minimizes fluid leakage and maximizes contamination exclusion. Our rod seals are designed with knife-trimmed lips to ensure the best possible film breaking. This dry rod technology permits the wiper to be extremely aggressive, excluding contamination without building up oil leakage around the wiper. Another systems approach to effectively control leakage is to incorporate multiple sealing lips. Parker's BR buffer ring, BT u-cup and AH double-lip canned wiper are designed to work together to give optimized performance and the driest sealing available in the industry (see Figure 2-2).



Figure 2-2. BR, BT, AH sealing system for leakage control

Even when appropriate seals are specified, it is still possible to experience leakage due to factors extending beyond the seals themselves. Examples are hardware considerations like surface finish and installation damage, seal storage, chemical wash downs, maintenance and contamination. Adhering to the design recommendations found herein not only for seals, but also for the mating hardware will provide the greatest likelihood of minimized leakage.

## Lip vs. Squeeze Seals

The cross-sectional shape of a seal dramatically affects how it functions, especially at low pressure. The greatest trade-off in dynamic sealing is low friction performance vs. low pressure sealability. At low pressure, friction, wear and sealing ability are affected by whether or not the seal is a lip or squeeze profile (see Figure 2-3). With this in mind, seals are often categorized as either "lip seals" or "squeeze seals," and many fall somewhere in between. Lip seals are characterized by low friction and low wear; however, they also generate poor low pressure sealability. Squeeze seals are characterized by just the opposite: high friction and high wear, but better low pressure sealability.

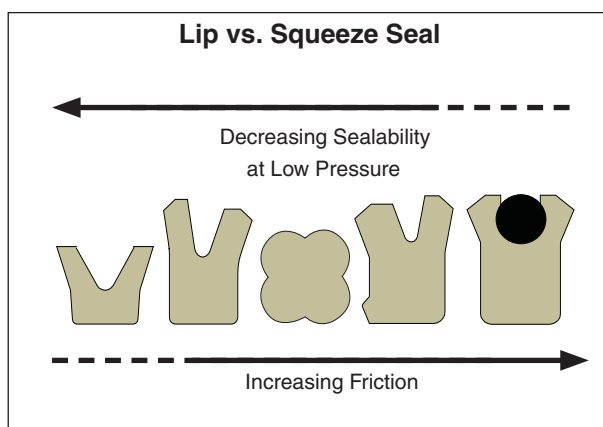

Figure 2-3. Lip seal vs. squeeze seal

As described above, a squeeze type seal will generate much more sealing force than a lip type seal. The assumption here is that both seals are under zero or low pressure. However, as fluid pressure increases, the differences between seal types become insignificant due to the force from the fluid pressure overcoming the designed squeeze. Pressure generally improves leakage control, but increases friction and its associated heat, wear and potential for extrusion.

In pneumatic applications, low friction is of the utmost importance. As such, lip seals are an excellent choice for these low pressure applications. Conversely, in hydraulic cylinders, where high system pressures easily overcome frictional forces, squeeze seals are often the appropriate choice. An example of a hydraulic application in which a squeeze seal would not be appropriate is a gravity returned hydraulic ram. In this case, a lip type hydraulic seal would generate lower friction, allowing the gravity return to function properly.

09/01/07



## Effects of Lip Geometries

Lip geometry will determine several functions of the seal. Force concentration on the shaft, film breaking ability, hydroplaning characteristics and contamination exclusion are all factors dependent on lip shape. Table 2-1 shows four different lip shapes and provides helpful insights for choosing an appropriate lip geometry.

**Table 2-1. Seal lip contact shape**

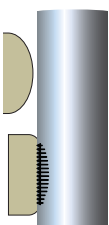
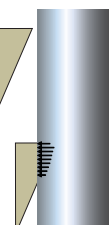
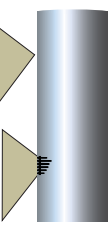
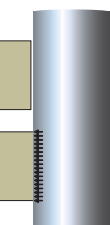
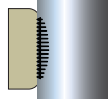
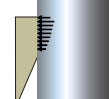
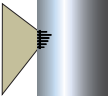
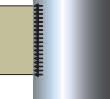
Contact Shape	Rounded	Straight Cut	Beveled	Square
Seal Lip Shape				
Shape of Contact Force/Stress Profile				
Film Breaking Ability	Low	High	Very High	Medium
Contamination Exclusion	Low	Very High	Low	High
Tendency to Hydroplane	High	Very Low	Low	Medium
Typical Uses	Pneumatic U-cups	Wipers and Piston Seals	Rod Seals	Piston Seals

## Friction

Friction is a function of the radial force exerted by the seal and the coefficient of friction between the seal and the dynamic sealing surface. Reducing friction is generally desirable, but not always necessary. Friction is undesirable because of heat generation, seal wear and reduced system efficiency.

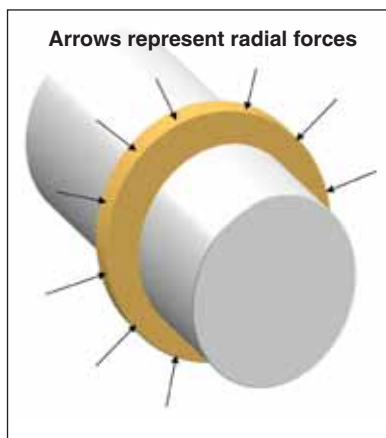

**Figure 2-4. Radial force**

Factors that affect the radial force are:

- Pressure
- Material modulus
- Temperature
- Lip geometry
- Squeeze vs. lip seal

Factors that affect the coefficient of friction are:

- Seal material
- Dynamic surface roughness
- Temperature
- Lubrication

When the proper seal selection is made, most seals will function such that friction is not a concern. However, when friction becomes critical, there are several ways to reduce it:

- Reduce the lip cross-section
- Decrease lip squeeze
- Change seal material
- Evaluate the hardware's surface finish
- Reduce system pressure
- Improve lubrication

Lowering friction increases seal life by reducing wear, increasing extrusion resistance, decreasing compression set and the rate of chemical attack.

**Breakaway friction** must be overcome for movement to begin. It is influenced by the duration in which an application remains stationary. The longer the duration, the more lubrication will be forced out from between the seal and the contacting surface. The seal material then conforms to the profile of the surface finish. These events increase breakaway friction.

Stick-slip is characterized by distinct stop-start movement of the cylinder, and may be so rapid that it resembles severe vibration, high pitched noise or chatter. Seals are often thought to be the source of the stick-slip, but other components or hardware can create this issue.

Causes of stick-slip include swelling of wear rings or back-up rings, extreme side-loading, valve pulsation, poor fluid lubricity, external sliding surfaces or seal pressure trapping. This condition can be puzzling or difficult to resolve. Possible causes and troubleshooting solutions are listed in the following Table 2-2.

**Table 2-2. Stick-slip causes & troubleshooting tips**

Possible Causes	Troubleshooting Tips
Surface finish out of specification	Verify surface is neither too smooth or too rough
Poor fluid lubricity	Change fluid or use oil treatments or friction reducers
Binding wear rings	Check gland dimensions, check for thermal or chemical swell
Side loading	Review cylinder alignment, incorporate adequate bearing area
Seal friction	Use material with lower coefficient of friction
Cycle speed	Slow movement increases likelihood of stick-slip
Temperature	High temperature softens seals, expands wear rings, and can cause thermal expansion differences within hardware
Valve pulsation	Ensure valves are properly sized and adjusted
External hardware	Review system for harmonic resonance

**Pressure Effects and Extrusion**

Extrusion occurs when fluid pressure forces the seal material into the clearance gap between mating hardware. Dynamic motion further promotes extrusion, as surfaces in motion tend to pull material into the extrusion gap, generating additional frictional forces and heat. This can cause premature failure via several modes. Extruded seal material can break away and get caught underneath sealing lips, creating leak paths. As material continues to break away, seal geometry erodes, causing instability and eventual leakage. Additionally, heat generated from added friction will cause the seals to take a compression set, dramatically shortening their life.

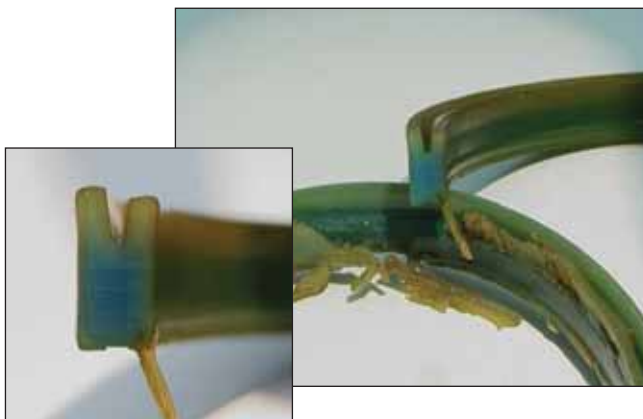

**Figure 2-5. Extrusion damage**

Careful design considerations should be evaluated to prevent extrusion. For example, minimizing clearance gaps and selecting a proper material based on system temperature, pressure and fluid are both helpful in reducing the risk of extrusion. As clearance gaps increase, less pressure is required in order for extrusion to occur. Higher temperatures can also play a role in this effect by causing seal materials to soften, encouraging extrusion at lower pressures. If the seal material chosen is not suitable to be used in the system fluid, softening due to chemical attack can also decrease its ability to resist extrusion.

The following Table 2-3 lists possible causes of extrusion and troubleshooting tips for preventative or corrective measures.

**Table 2-3. Extrusion causes and troubleshooting tips**

Possible Causes
Large extrusion gaps
High operating temperature
Soft materials
High system pressure
Pressure spikes
Side loading
Wear rings
Chemical compatibility
Troubleshooting Tips
Reduce extrusion gaps
Check gland dimensions
Replace commercial grade wear rings with tight tolerance wear rings
Incorporate back-up rings
Evaluate size and positioning of wear rings for side load resistance
Consider harder, higher modulus and tensile strength compound
Match seal compound for pressure, temperature and fluid compatibility

By definition, the radial gap is one-half of the diametrical gap. The actual extrusion gap is often mistaken as the radial gap. This is too optimistic in most cases because side loading of the rod and piston will shift the diametrical clearance to one side. Often, gravity alone is sufficient for this to occur. Good practice is to design around worst case conditions so that extrusion and seal damage do not occur. Table 2-4 provides maximum *radial* extrusion gaps for various seal compounds.

**As a general rule of thumb, the pressure rating of dynamic seals will be approximately one-half that of static seals.**

09/01/07





Table 2-4. Typical pressure ratings for standard seal compounds in reciprocating applications at 160°F (see Note)

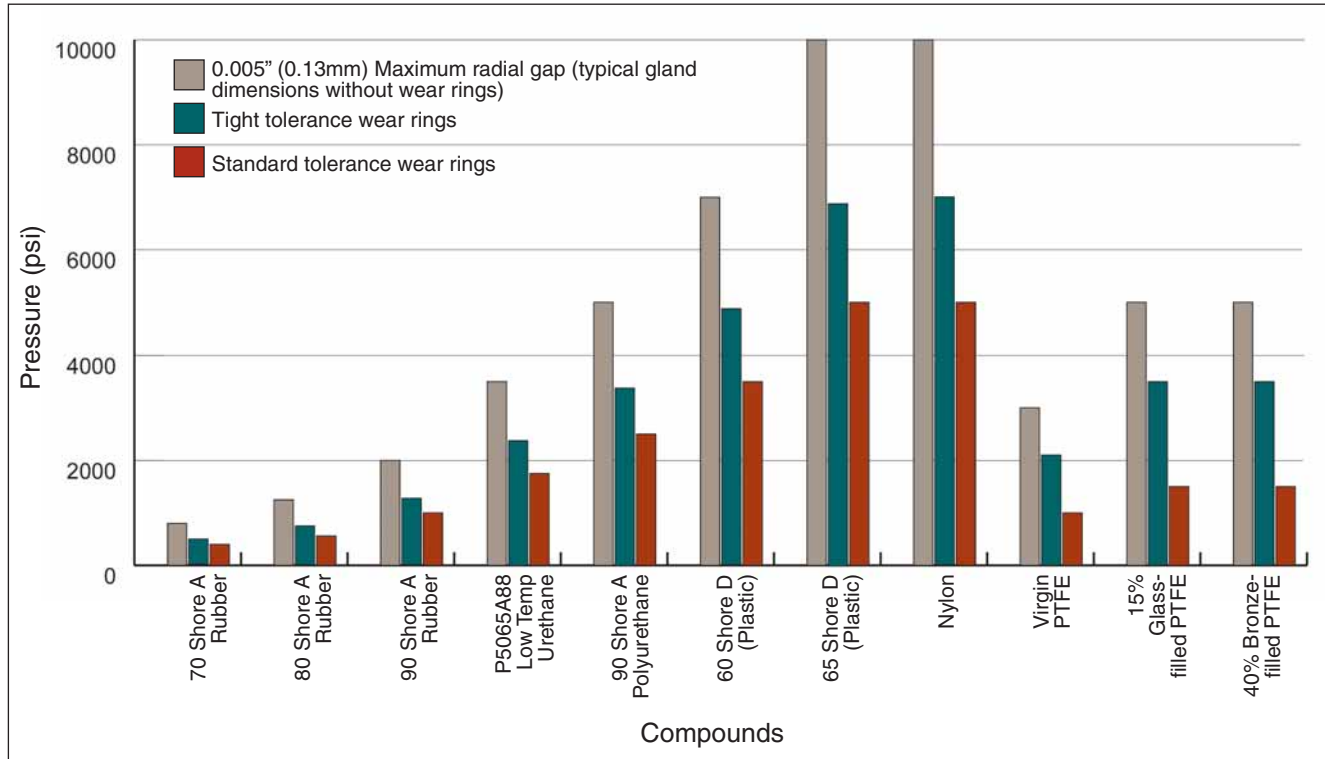

**Note:** Pressure ratings are based upon a test temperature of 160° F (70 °C). Lower temperatures will increase a material's pressure rating. Higher temperatures will increase pressure ratings. Maximum radial gap is equal to the diametrical gap when wear rings are not used. Wear rings keep hardware concentric, but increase extrusion gaps to keep metal-to-metal contact from occurring, thereby decreasing pressure ratings when used.

As noted in Table 2-4, pressure ratings decrease when wear rings are used due to the larger extrusion gaps required to eliminate metal-to-metal contact. If wear rings are used, be sure to consult Section 9 (Wear Rings) and Section 10 (Back-ups) for appropriate hardware dimensions. **Wear ring hardware dimensions for the piston and rod throat diameters always supersede those dimensions called out for the seals themselves.**

**Seal Wear**

Seals will inevitably wear in dynamic applications, but with appropriate design considerations, this can be minimized. The wear pattern should be even and consistent around the circumference of the dynamic lip. A small amount of even wear will not drastically affect seal performance; however, if the wear patterns are uneven or grooved, or if the amount of wear is excessive, performance may be dramatically reduced. There are many factors that influence seal wear, many of which are described in the following Table 2-5.

Table 2-5. Factors influencing seal wear

Factors that Influence Seal Wear	
Rough surface finish	Excessive abrasion may occur above 12 µin Ra
Ultra smooth surface finish	Surface finishes below 2 µin Ra can create aggressive seal wear due to lack of lubrication
High pressure	Increases the radial force of the seal against the dynamic surface
High temperature	While hot, materials soften, thus reducing tensile strength
Poor fluid lubricity	Increases friction and temperature at sealing contact point
Tensile strength of seal compound	Higher tensile strength increases the material's resistance to tearing and abrading
Fluid incompatibility	Softening of seal compound leads to reduced tensile strength
Coefficient of friction of seal compound	Higher coefficient materials generate higher frictional forces
Abrasive fluid or contamination	Creates grooves in the lip, scores the sealing surface and forms leak paths
Extremely hard sealing surface	Sharp peaks on hard surfaces will not be rounded off during normal contact with the wear rings and seals, accelerating wear conditions

Seal wear may be indicated by flattening out of the contact point, or, in extreme circumstances, may appear along the entire dynamic surface as shown in Figure 2-6.

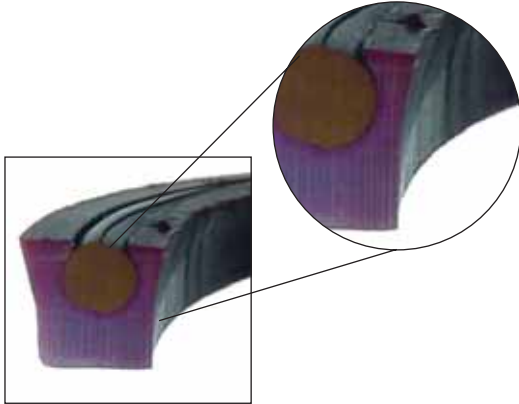

Figure 2-6. Seal wear on dynamic surface

## Seal Stability

Dynamic stability is integral to a seal's performance, allowing the lip to effectively contact the sealing surface, eliminating rocking and pumping effects and promoting an even wear pattern at the sealing contact point. Instability can create leakage and seal damage. A typical instability malfunction known as "spiral failure" can occur when o-rings are used in reciprocating applications. Due to frictional forces that occur while the system is cycling, the o-ring will tend to roll or twist in the groove, causing leakage and even possible breakage. A square geometry will tend to resist this better than a round profile, but is not impervious to instability failure. Rectangular geometries provide the best stability in dynamic applications.

Other less obvious factors that influence the stability of a seal are:

- Percent gland fill
- hardness or stiffness of the seal material



Fig. 2-7. Instability failure of a square profile piston seal

- Rough surfaces which create high friction
- Cross-section (larger is better)
- Design features of a seal (i.e. stabilizing lip, non-symmetrical design). Figure 2-8 illustrates how design features can make a seal more stable. In the first FEA plot, the seal is centered in the gland and does not incorporate a stabilizing lip. In the second plot, the seal is loaded against the static gland and includes a stabilizing lip. Stability has been enhanced by the design changes.

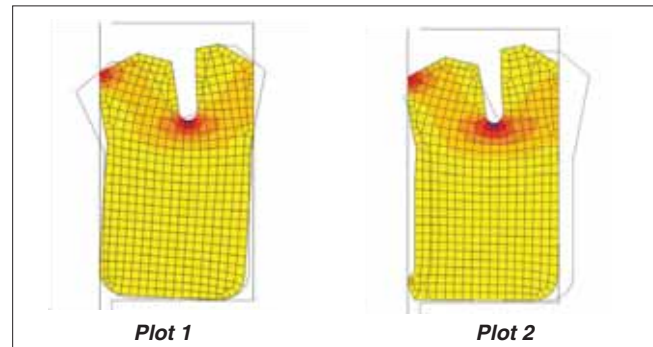

Figure 2-8. Design improvements for increased stability

## Surface Speed

The surface speed of a reciprocating shaft can affect the function of a seal. Hydroplaning and frictional heat may occur with excessive speed, while stick-slip, discussed previously in the friction section, is most often associated with slow speed.

Hydroplaning occurs when hydrodynamic forces lift the sealing lip off of the dynamic surface, allowing fluid to bypass the seal. The lip geometry, as well as the overall force on the lip, will influence its ability to resist hydroplaning. Most hydraulic seals are rated for speeds up to 20 inches/second (0.5 m/second), but this may be too fast for certain lip geometries or when the seal has a lightly loaded design. Table 2-1 on page 2-3 shows which lip geometries are subject to hydroplaning. Straight cut and beveled lip geometries are the most effective at resisting hydroplaning so long as sufficient lip loading is present to overcome the hydrodynamic forces.

High surface speeds can create excessive frictional heat. This can create seal problems when the dynamic surface is continuously moving. The under-lip temperature of the seal will become much hotter than the system fluid temperature, especially when the seal is under pressure. If the heat being generated cannot be dissipated, the seal will experience compression set, wear, extrusion and/or increased chemical attack.

09/01/07

## Compression Set

Compression set is the inability of a seal to return to its original shape after being compressed. As defined by ASTM, it is the percent of deflection by which the seal fails to recover after a specific deflection, time and temperature. Compression set is calculated using the following equation:

$$\text{Compression Set} = \frac{H_i - H_R}{H_i - H_C} \times 100$$

where

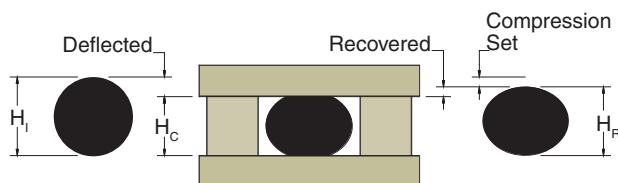

$H_i$  = Initial height

$H_c$  = Compressed height

$H_R$  = Recovered height

Compression set reduces sealing forces, resulting in poor low pressure sealability. It takes place primarily because of excessive exposure to a high temperature. A material's upper end temperature limit may give an indication of its compression set resistance. Although compression set always reduces the seal's dimensions, chemical swell or shrinkage can either positively or negatively impact the final geometry of the seal. If material shrinkage occurs due to the system fluid, the deflection of the seal will decrease, accelerating leakage. If chemical swell is present, it can negate or offset the negative effects of compression set. While it is true that swelling can offset compression set, extreme fluid incompatibility can break down the polymer's chemical structure and cause the material to be reformed in its compressed state.

*Lip wear is also a dimensional loss, but is not related to compression set. Dimensional loss due to lip wear will increase the final compression set value.*

The seal shown in Figure 2-9 exhibits nearly 100% compression set with minimal wear. Note how the lips flare out very little.



Figure 2-9. Seal exhibiting nearly 100% compression set

## Influence of Temperature

All seal materials have a specified operating temperature range (see Section 3, Materials). These temperatures are provided as guidelines and should not be used as specification limits. It is wise practice to stay well within this range, knowing that physical properties are severely degraded as either limit is approached.

Temperature affects extrusion, wear, chemical resistance and compression set, which ultimately influences the sealing ability of a product. High temperatures reduce abrasion resistance, soften materials, allowing them to extrude at lower pressures, increase compression set and can accelerate chemical attack. Low temperatures can cause materials to shrink and harden, reducing resiliency and sealability. Some of these problems can be solved by using low temperature expanders or metal springs as a



Figure 2-10. Progressive effect (hydrolysis) of high temperature water on standard urethane seals (yellow) vs. Parker Resilon WR (4301) seals (aqua).

component of the seal selection (see Section 3, Materials).

09/01/07

## General Guidelines for Hardware Design

For easy assembly and to avoid damage to the seal during assembly, Parker recommends that designers adhere to the tolerances, surface finishes, leading edge chamfers and dimensions shown in this catalog.

2

Table 2-6.

Installation Chamfer, Gland Radius, and Taper		
Seal Cross Section	"A" Dimension	"R" Dimension
1/16	0.035	0.003
3/32	0.050	0.015
1/8	0.050	0.015
5/32	0.070	0.015
3/16	0.080	0.015
7/32	0.080	0.015
1/4	0.080	0.015
9/32	0.085	0.015
5/16	0.085	0.015
11/32	0.085	0.015
3/8	0.090	0.015
13/32	0.095	0.015
7/16	0.105	0.030
15/32	0.110	0.030
1/2	0.120	0.030
17/32	0.125	0.030

Installation Chamfer, Gland Radius, and Taper		
Seal Cross Section	"A" Dimension	"R" Dimension
9/16	0.130	0.030
19/32	0.135	0.040
5/8	0.145	0.040
21/32	0.150	0.040
11/16	0.160	0.040
23/32	0.165	0.040
3/4	0.170	0.040
25/32	0.180	0.060
13/16	0.185	0.060
27/32	0.190	0.060
7/8	0.200	0.080
29/32	0.205	0.080
15/16	0.215	0.080
31/32	0.220	0.080
1	0.225	0.080

Figure 2-10.

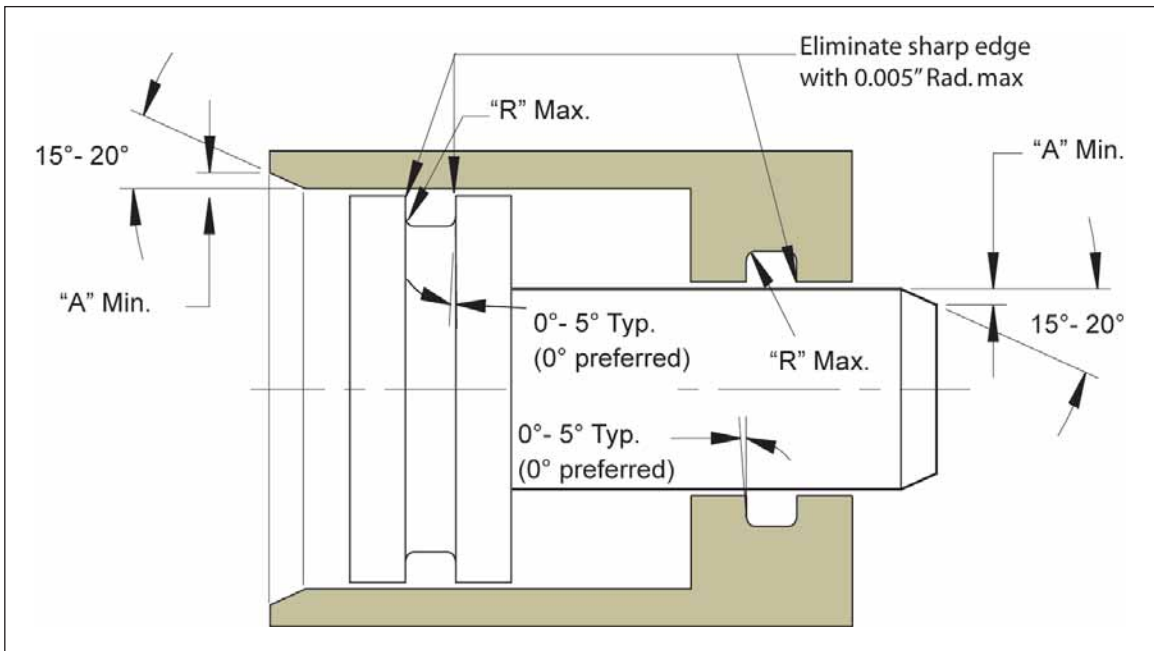

09/01/07



## Hardware Surface Finish

Understanding and applying the benefits of appropriate surface finish specifications can dramatically affect the longevity of a sealing system. In a dynamic surface, microscopic variations form recesses which hold an oil film between the seal lip and the moving surface. If the surface is too smooth, friction and seal wear will be high because this oil film will not be present. If the surface is too rough, the variations will create leak paths and accelerate lip wear. For these reasons, it is critical to have an in depth understanding of surface finishes as they pertain to dynamic sealing systems. As such, Parker recommends following the guidelines for surface finish as outlined below or conducting individual testing for specific applications to validate seal function and expected life.

Over the years, greater attention has been given to this subject as realizations about warranty savings and system life become more prevalent. As equipment required to measure and maintain a proper surface finish has evolved and improved, the subject of surface finish has become more complex. Traditional visual inspection gauges are no longer sufficient to effectively measure surface finish. Profilometers are now commonly used to achieve precise measurements with repeatable results. In the same way, the terms used to define a surface finish have also advanced.

For many years, a single surface parameter has often been used to quantify surface finish. RMS (also known as Rq) stands for Root Mean Square and has historically been the most typical value. In more recent years, the Arithmetic Average Roughness, Ra, has become more frequently specified. Using either of these parameters by itself is inadequate to define a proper reciprocating sealing surface. Figure 2-11 depicts why this parameter alone cannot accurately describe a surface finish.

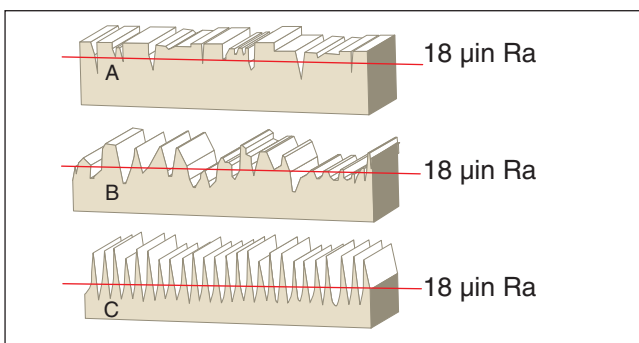

Figure 2-11. Different surface finishes yielding same Ra value

The three surface finishes shown in Figure 2-11 all have the same Ra value but very unique characteristics. The first profile (A) is an example of a proper surface finish for dynamic seals in which the sharp peaks have been minimized or removed. The second profile (B) will exhibit high wear characteristics because of the wide spacing between the peaks. The third profile (C) will also wear out the seals quickly because of its extremely sharp peaks.

Ra is sufficient to define the magnitude of surface roughness, but is insufficient to define a surface entirely in that it only describes the average deviation from the mean line, not the nature of the peaks and valleys in a profile. To obtain an accurate surface description, parameters such as Rp, Rz and Rmr (tp) can be used to define the relative magnitude of the peaks and the spacing between them. These parameters are defined in Table 2-7, and their combination can identify if a surface is too rough or even too smooth for reciprocating applications.

There are other parameters that can be considered for surface finish evaluation. For example, the limitation of Rt is that it considers only one measurement, while Rz, Rp and Rmr consider the full profile.

**RMS = Rq.** The Root Mean Square (RMS) as defined by ISO 4287:1997 and other standards is often defined as Rq. These terms are interchangeable.

**Rq ≠ Ra.** Confusion has typically surrounded surrounding these values, leading to misconceptions that they are interchangeable. Rq and Ra will never be equal on typical surfaces. Another misconception is that there is an approximate 11% difference between the two. *Ground and polished* surfaces can have Rq values that are 20 to 50 percent higher than Ra. The 11% difference would only occur if the surface being measured took the form of a true sine wave. A series of tests conducted at Parker have shown Rq to be 30% higher than Ra on average.

**What's the Significance?** Specifications previously based on a maximum surface finish of 16 µin RMS for *ground and polished* rods should specify a maximum finish of **12 µin Ra**.

Table 2-7. Roughness parameter descriptions

**Parameter Descriptions**

*Roughness parameters are defined per ISO 4287:1997 and ISO 4288:1996.*

**Ra\*** – Arithmetic average or mean deviation from the center line within a sampling length.

**Rq\*** – Root mean square deviation from the center line within a sampling length.

**Rp\*** – Maximum profile peak height within a sampling length. Also known as  $R_{pm}$  in ASME B46.1 – 2002.

**Rv\*** – Maximum profile valley depth within a sampling length. Also known as  $R_{vm}$  in ASME B46.1 – 2002.

**Rz\*** – Maximum height of profile within a sampling length ( $Rz = Rp + Rv$ ).

NOTE: ISO 4287:1984, which measured five peaks and five valleys within a sampling length, is now obsolete. This value would be much lower because additional shorter peaks and valleys are measured. Over the years there have been several Rz definitions used. Care needs to be taken to identify which is used.

**Rt** – Maximum height of the profile within the evaluation length. An evaluation length is typically five sampling lengths.

**Rmr** – Relative material ratio measured at a given height relative to a reference zero line. Indicates the amount of surface contact area at this height. Also known as  $t_p$  (bearing length ratio) in ASME B46.1 – 2002.

\*Parameters are first defined over a sampling length. When multiple sampling lengths are measured, an average value is calculated, resulting in the final value of the parameter. The standard number of sampling lengths per ISO 4287:1997 and ISO 4288:1996 is five.

Figure 2-12 graphically represents Ra. The shaded area, which represents the average height of the profile, Ra, is equal to the area of the hatched portion. The mean line, shown in red, splits the hatched area in half and forms the center line for Ra. The graph also shows Rq, which is higher than Ra.

Figure 2-13 shows the actual surface profile of a polished chrome rod.

Upon examination of the profile, it can be seen that the polishing operation has removed or rounded the peaks producing a positive affect on the characteristics of the sealing surface, as described below by Ra, Rp, Rz and Rmr.

- Ra = 8.9  $\mu$ m
- Rp = 14.8  $\mu$ m (which is 1.7 x Ra, less than the 3x guideline)
- Rz = 62.9  $\mu$ m (which is 7.1 x Ra, less than the 8x guideline)
- Rmr = 74%

Figure 2-13 also illustrates how Rp and Rz are calculated using the following equations:

$$Rp = \frac{Rp1 + Rp2 + Rp3 + Rp4 + Rp5}{5}$$

$$Rz = \frac{Rz1 + Rz2 + Rz3 + Rz4 + Rz5}{5}$$

NOTE: In the profile shown in Figure 2-13,  $Rt = Rz2$  because the tallest peak and deepest valley occur in the same sampling length.

Figure 2-14 considers the same surface and illustrates how the Rmr value of 74% is determined. To accomplish this, locate the height of the curve at 5% material area (this is the reference line or “zero line”). From this height, move down a distance of 25% Rz and locate the new intersection point along the curve. This new intersection point is the actual Rmr value of 74%.



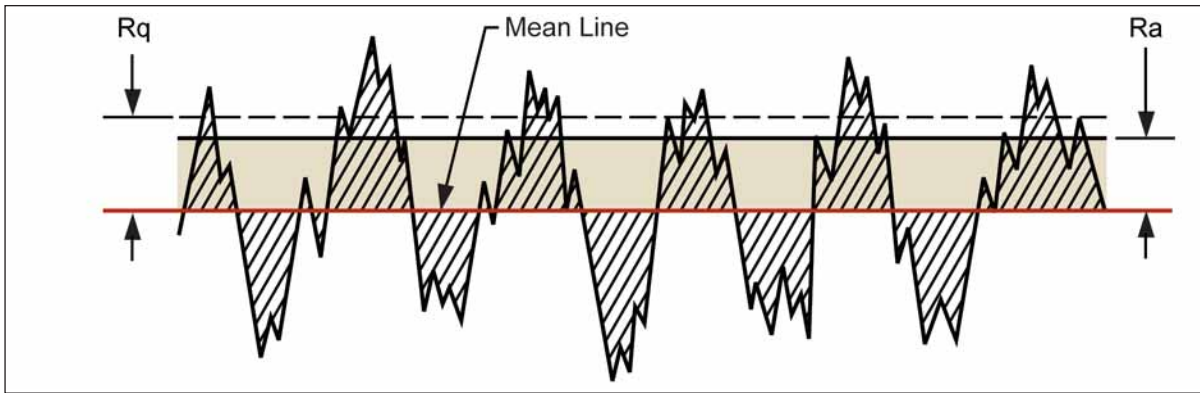

Figure 2-12.

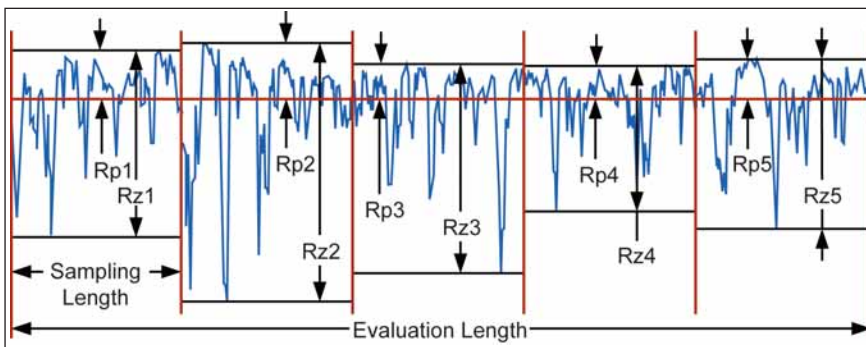

Figure 2-13.

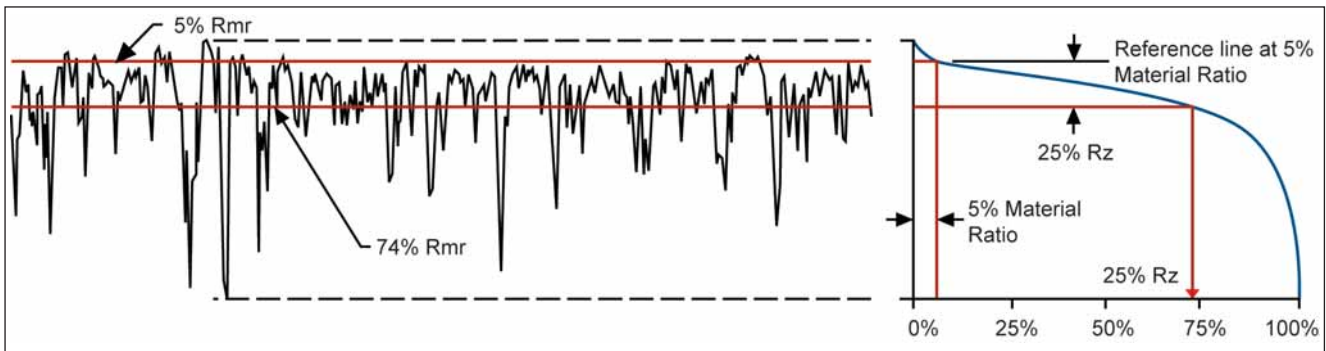

Figure 2-14.

### Surface Finish Guidelines for Reciprocating Seals

Recommendations for surface roughness are different for static and dynamic surfaces. Static surfaces, such as seal groove diameters, are generally easier to seal and require less stringent roughness requirements; however, the type of fluid being sealed can affect the guidelines (see Table 2-8). It is important to remember that surface finish recommendations will vary depending upon the seal material of choice. PTFE seals require smoother finishes than seals made from polyurethane and most rubber compounds.

Four parameters have been selected to define a proper surface finish for hydraulic and pneumatic reciprocating applications. These parameters are Ra, Rp, Rz and Rmr. For descriptions of these parameters, please consult Table 2-8.

*Grinding as a final process for dynamic sealing surfaces is rarely sufficient. In order to obtain an acceptable Rmr value, the surface must often be ground **and** polished. If the surface is not polished in addition to being ground, the ratio of Rp and Rz to Ra will be too high or Rmr ratio too low.*

**Table 2-8. Surface Finish Guidelines**

Ra Guidelines				
Application	Thermoplastic and Rubber Seals		PTFE Seals	
	Dynamic Surfaces	Static Surfaces	Dynamic Surfaces	Static Surfaces
Cryogenics	-	-	4 µin (0.1 µm) Maximum	8 µin (0.2 µm) Maximum
Helium Gas Hydrogen Gas Freon	3 to 10 µin (0.08 to 0.25 µm)	12 µin (0.3 µm) Maximum	6 µin (0.15 µm) Maximum	12 µin (0.3 µm) Maximum
Air Nitrogen Gas Argon Natural Gas Fuel (Aircraft and Automotive)	3 to 12 µin (0.08 to 0.3 µm)	16 µin (0.4 µm) Maximum	8 µin (0.2 µm) Maximum	16 µin (0.4 µm) Maximum
Water Hydraulic Oil Crude Oil Sealants	3 to 12 µin (0.08 to 0.3 µm)	32 µin (0.8 µm) Maximum	12 µin (0.3 µm) Maximum	32 µin (0.8 µm) Maximum
Rp Guidelines				
Application	Thermoplastic and Rubber Seals		PTFE Seals	
	Dynamic Surfaces	Static Surfaces	Dynamic Surfaces	Static Surfaces
All media/fluids	If Ra ≥ 5 µin (0.13 µm), then Rp ≤ 3 × Ra	-	If Ra ≥ 5 µin (0.13 µm), then Rp ≤ 3 × Ra	-
	If Ra < 5 µin (0.13 µm), then Rp ≤ 3.5 × Ra		If Ra < 5 µin (0.13 µm), then Rp ≤ 3.5 × Ra	
	Example: If Ra = 4 µin, then Rp ≤ 14 µin.			
Rz Guidelines				
Application	Thermoplastic and Rubber Seals		PTFE Seals	
	Dynamic Surfaces	Static Surfaces	Dynamic Surfaces	Static Surfaces
All media/fluids	Rz ≤ 8 × Ra and 70 µin (1.8 µm) Maximum	Rz ≤ 6 × Ra	Rz ≤ 8 × Ra and 64 µin (1.6 µm) Maximum	Rz ≤ 6 × Ra
	Example: If Ra = 4 µin, then Rz ≤ 32 µin (dynamic calculation)			
	Note: Rz values above maximum recommendations will increase seal wear rate.			
Rmr Guidelines				
Application	Thermoplastic and Rubber Seals		PTFE Seals	
	Dynamic Surfaces	Static Surfaces	Dynamic Surfaces	Static Surfaces
All media/fluids	45% to 70% (thermoplastic)	-	60% to 90%	-
	55% to 85% (rubber materials)			
	Rmr is measured at a depth of 25% of the Rz value based upon a reference level (zero line) at 5% material/bearing area.			

## Surface Finish FAQs

### What is the difference between RMS (Rq) and Ra?

RMS which stands for Root Mean Square (and now known as Rq), is one way of quantifying the average height of a surface. The Arithmetic Average, Ra, quantifies the surface in a different manner, providing a true mean value. These parameters will almost always be different, but there is not an exact relationship between the two for a typical sealing surface of random peaks and valleys. If a surface were to perfectly resemble a sine wave, the result would place the RMS value 11% higher than Ra, but this is not a very realistic scenario. On various ground and polished surfaces, RMS has been observed to be as much as 50% higher than Ra, but on average, runs about 30% higher. If this 30% average difference is applied to a 16  $\mu\text{m}$  RMS specification, the maximum recommended value would be 12  $\mu\text{m}$  Ra.

### Why are Rp and Rz specified as a function of Ra, and not simply a range?

Take a shaft with the minimum recommended value of Ra = 3  $\mu\text{m}$ , for example. Using the formula for Rz, the maximum value would be calculated as 24  $\mu\text{m}$  (8 x 3). If the requirement simply stated a range that allowed Rz values up to 70  $\mu\text{m}$ , this large difference indicates that the surface profile could have many large, thin surface peaks which would abrade the seal quickly. By the same regard, a maximum Ra value of 12  $\mu\text{m}$  would result in an Rz value of 96  $\mu\text{m}$  (12 x 8), which is beyond the recommended maximum value of 70  $\mu\text{m}$ . The same principle applies for Rp: peaks should be removed to reduce seal wear via a polishing process. Grinding without polishing can leave many abrasive surface peaks.

### Why is Ry (also known as Rmax) not used in Parker's roughness specification?

Ry only provides a single measurement (a vertical distance from one peak to valley) within the whole evaluation length. In actuality, there may be several peaks and valleys of similar height, or there may only be one large peak or valley. Rp and Rz provide much more accurate results, showing the average of five peak to valley measurements (one measurement in each of the five sampling lengths). Furthermore, ISO 4287:1997 and ISO 4288:1996 standards no longer incorporate the use of Ry.

### How can a dynamic surface finish be too smooth?

There are two areas of concern that have been observed on extremely smooth surfaces, the first being seal wear, the second being leakage. When surface finishes have been measured at or below 1  $\mu\text{m}$  Ra, an extremely accelerated seal wear rate has been observed. A small jump to 1.8 to 2  $\mu\text{m}$  Ra shows significant improvement, indicating that the extremely low range should be avoided. With higher values showing even greater life extension, the optimal range for Ra has been determined to be 3 to 12  $\mu\text{m}$ .

Regarding leakage, some seal designs that function well with 6 to 12  $\mu\text{m}$  Ra finishes begin to leak when the finish falls below 3  $\mu\text{m}$  Ra. Due to technological advances, there are many suppliers who manufacture rods with finishes this smooth. It is always necessary to validate seal performance, especially if using an ultra-smooth dynamic surface.

### When does a dynamic surface finish become too rough?

Although it is possible for some seals to function when running on rough finishes, there are always concerns with accelerated wear and leakage control. Certain seals have been able to function at 120  $\mu\text{m}$  Ra finishes for short periods of time, but seal life in these cases can be reduced up to five or six times. On the contrary, some seals have failed at surface finishes as low as 16  $\mu\text{m}$  Ra when pressure was insufficient to effectively energize the sealing lips as they rapidly wore out. Even though a rough finish is not a guaranteed failure mode, it is always best to stay within the recommended specifications. Remember that a proper finish also meets the recommendations for Rp, Rz and Rmr listed in the surface roughness guidelines.

## Installation

### Considerations

2

Installation techniques may vary considerably from case to case, depending on whether a seal is being replaced as a maintenance procedure or being installed in the original manufacture of reciprocating assemblies. Variations also arise from differences in gland design. A two-piece, split gland design, although rarely used, poses fewer problems than a “snap-in” groove positioned deep inside the body of a long rod gland. In production situations, or where frequent maintenance of similar or identical assemblies is performed, it is customary to utilize special tools to permit fitting a seal into its groove without overstressing it or subjecting it to nicks and cuts during insertion.

The common issues associated with all installation procedures are:

**1. Cleanliness.** The seal and the hardware it must traverse on its way into the groove, as well as the tools used to install the seal, must be cleaned and wiped with lint-free cloths.

**2. Nick and Cut Protection.** Threads, sharp corners and burrs can damage the seal. Care should be taken to avoid contact with these surfaces. Burrs must be removed, sharp corners should be blunted or radiused, and threads should be masked or shielded with special insertion tooling (see Figure 2-15). Although it is good practice to take extra care in the handling and manipulation of the seal, this is seldom sufficient and it usually requires either a safety tool or masking to protect the seal against such damage.

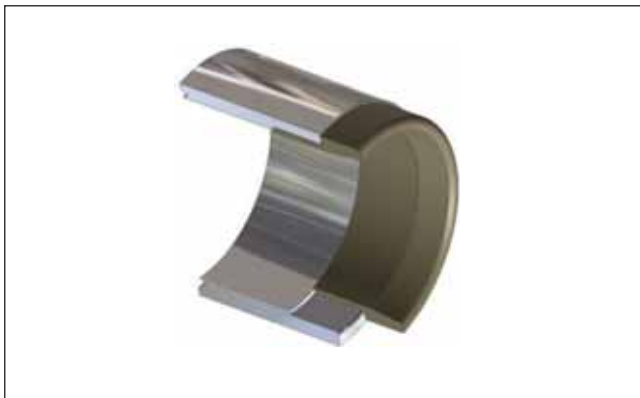

Figure 2-15. Thread protection installation tool cutaway view

**3. Lubrication.** Both the seal and its installation path must be lubricated prior to insertion. The lubricant should be selected for its compatibility with the seal compound and the working fluid it will later encounter. Often, the working fluid itself can be used

Table 2-9. Seal installation lubricants

Type	Temp. Range °F (°C)	Seal Use	Seal Material Compatibility
Petroleum base (Parker O Lube)	-20 to 180 (-29 to 82)	Hydrocarbon fluids; Pneumatic systems under 200 psi	Molythane, Resilon, Polymyte, Nitroxile, HNBR, NBR, FKM, (DO NOT use with EPR)
Silicone grease or oil (Parker Super O Lube)	-65 to 400 (-54 to 204)	General purpose; High pressure pneumatic	Molythane, Resilon, Polymyte, Nitroxile, HNBR, NBR, EPR, FKM
Barium grease	-20 to 300 (-29 to 149)	Pneumatic systems under 200 psi	Molythane, Resilon, Polymyte, Nitroxile, HNBR, NBR, FKM
Fluorocarbon fluid	-65 to 400 (-54 to 204)	Oxygen service	EPR

as the lubricant (see Table 2-9).

**4. Lead-in Chamfer.** A generous lead-in chamfer will act as a guide to aid in seal installation. With the proper lead-in chamfer, the seals can be installed without lip damage. Refer to Figure 2-16 below and Table 2-6 on page 2-8 for proper lead-in chamfer dimensions.

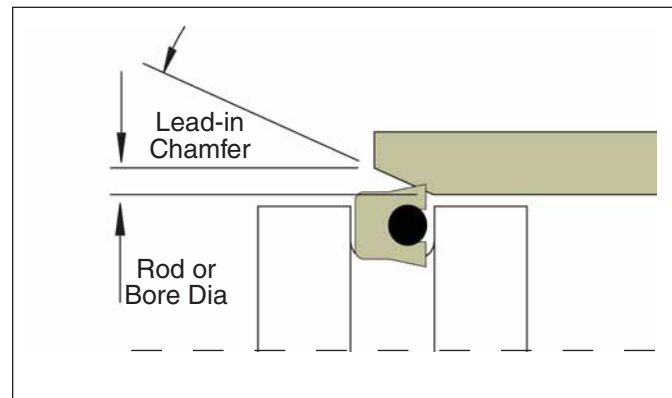

Figure 2-16. Seal installation lead-in chamfer

**5. Heating.** Where harder or fabric-reinforced compounds are used in snap-in applications, elasticity of the seal may fall short of that required for stretching or compressing onto (or into) the groove. Since seal compounds characteristically exhibit a high thermal coefficient of expansion, and tend to soften somewhat when heated, it is sometimes possible to “soak” the seals in hot lubricant to aid installation. Be sure to observe the compound temperature limits, and avoid heating the seals while stretched. Heating a seal while stretched will invoke the Gow-Joule effect and actually shrink the seal.

**6. Cross Section vs. Diameter.** Care must be taken to properly match a seal’s cross-section to its diameter. If the cross-section is too large in relation to the diameter, it will be difficult to snap-in or stretch the seal into the groove. This condition is typically only associated with polyurethane, PolyMyte and other high modulus materials. The data shown in Table 2-10 may be used as a guide to determine this relationship for ease of installation.

**Table 2-10. Seal cross section vs. diameter installation guide**

Installation Guide Cross Section vs. Diameter				
Cross Section	Minimum Diameter Rod Seal		Minimum Diameter Piston Seal	
	Poly-urethane	Polymyte	Poly-urethane	Polymyte
1/8"	.750 I.D.	1.000 I.D.	1.250 I.D.	1.750 I.D.
3/16"	1.000 I.D.	1.750 I.D.	1.750 I.D.	2.750 I.D.
1/4"	1.750 I.D.	2.750 I.D.	3.000 I.D.	4.500 I.D.
3/8"	3.000 I.D.	5.000 I.D.	6.000 I.D.	8.000 I.D.
1/2"	6.000 I.D.	8.000 I.D.	10.000 I.D.	12.000 I.D.
3/4"	8.000 I.D.	9.000 I.D.	15.000 I.D.	17.000 I.D.
1"	10.000 I.D.	10.000 I.D.	20.000 I.D.	25.000 I.D.

**7. Installation Tools.** Use installation tools as recommended (see pages 2-16 and 2-17).

**8. Itemize and Use a Check List.** All components required to complete a sealing assembly should be itemized and checked off as they are installed. The absence of any single component can cause the entire system to fail.



## Installation Tools - Piston Seals

2

The installation of piston seals can be greatly improved with the use of installation tooling. Tooling not only makes the installation easier, but also safer and cost effective for high volumes as seals are less likely to be damaged when using proper tooling. For piston seal installation using tooling, use the following steps:

1. Inspect all hardware and tooling for any contamination, burrs or sharp edges. Clean, debur, chamfer, or radius where necessary. Make sure the piston and groove are undamaged.

2. If using a two-piece energized cap seal, install the o-ring or rubber energizer into the groove per vendor specifications.

3. Install the expanding mandrel onto the piston (Figure 2-17).

4. Place the seal onto the expanding mandrel, and using the pusher, gently push the seal up the ramp until it snaps into place (Figure 2-18).

5. If back-up rings are to be used, install split versions into their proper location or use the mandrel method in Step 4 for non-split rings.

6. For PTFE cap seals, slide the resizing tool over the seal to compress the seal to its original diameter (Figures 2-19, 2-20).

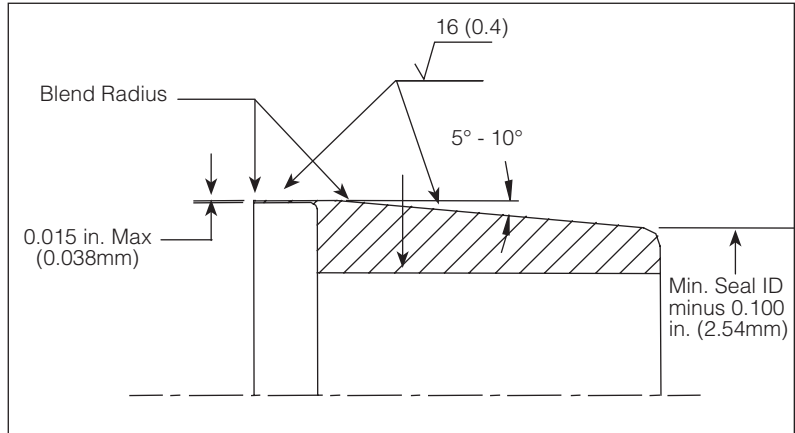

Figure 2-17. Expanding mandrel

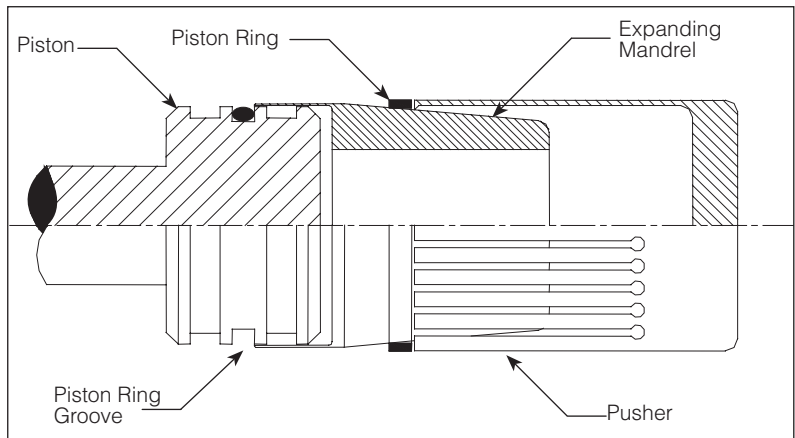

Figure 2-18. Installation of piston seal with tooling

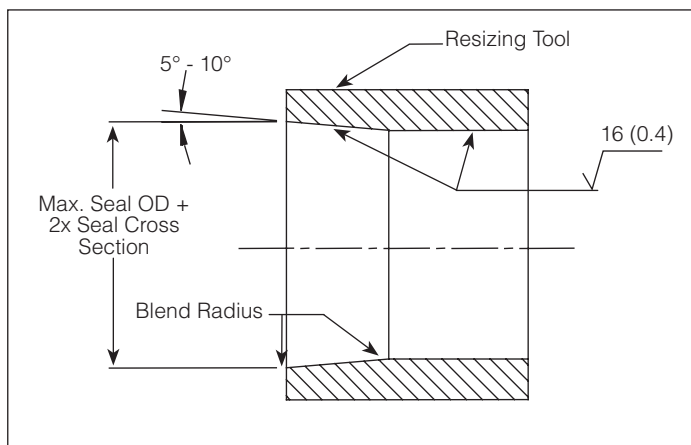

Figure 2-19. Resizing tool

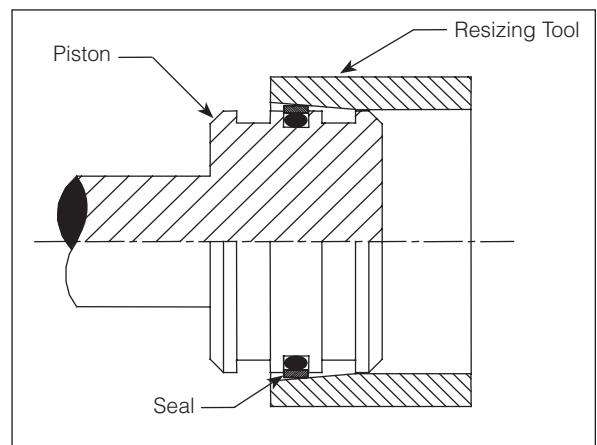

Figure 2-20. Resizing

09/01/07



## Installation Tools - Rod Seals

Many rubber, plastic and PTFE rod seals can be manipulated by hand for installation into the seal groove. Small diameter parts or parts with large cross sections may require a two piece (split) groove for installation. Special tooling can be utilized to help the installation process; however, PTFE and PolyMyte seals in particular require caution to ensure the sealing component is not nicked, dented or damaged. The following guidelines provide the steps for proper rod seal installation. If needed, please call your local Parker representative for recommendations.

1. Inspect all hardware and tooling for any contamination, burrs or sharp edges. Clean, debur, chamfer or radius where necessary. Make sure the bore, groove and rod are undamaged.

2. If using a two-piece, energized cap seal, first carefully install the o-ring or rubber energizer into the groove to ensure proper seating.

3. By hand, gently fold the seal into a kidney shape (Figure 2-21) and install into the groove. For rubber and polyurethane seals, the use of a three-prong installation tool can be helpful for folding the seal and installing it into the groove (Figure 2-22).

4. Unfold the seal into the groove, and using your finger, feel the inside diameter of the seal to make sure it is properly seated.

5. For PTFE seals, after unfolding the seal in the groove, use a resizing tool (Figure 2-23) to re-expand the seal.

6. If a back-up ring is to be used with the rod seal, position the seal toward the internal side of the groove to allow space for the back-up ring before installing it into place.

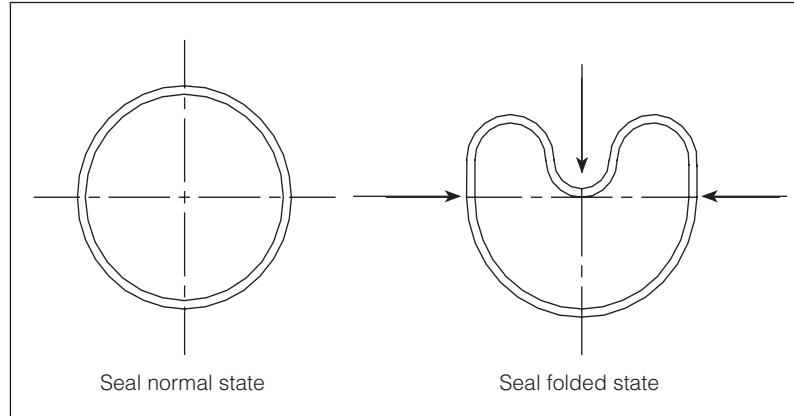

**Figure 2-21. Rod seal folding**

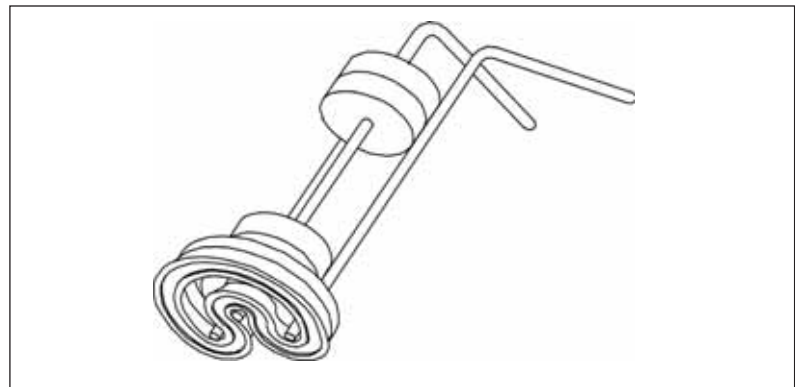

**Figure 2-22. Three-leg installation tool for polyurethane and rubber seals**

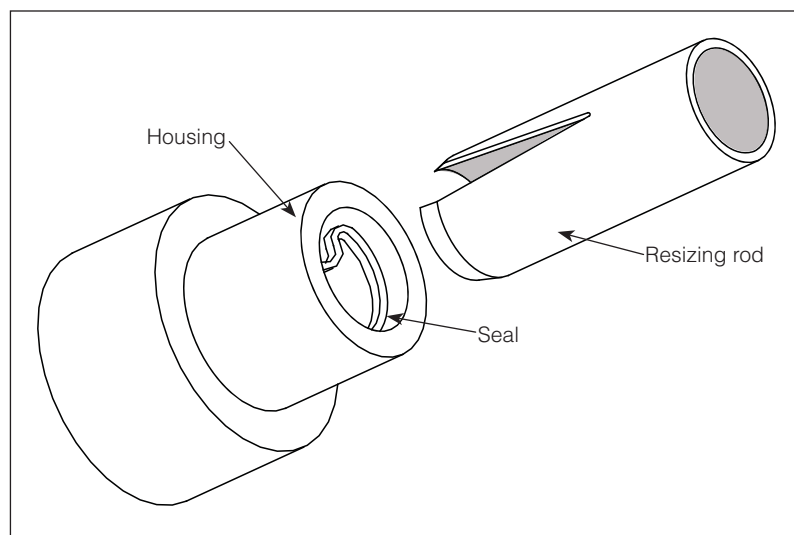

**Figure 2-23. Rod seal installation**

## Finite Element Analysis

2

Finite Element Analysis (FEA) is a powerful computer simulation tool that allows engineers to evaluate product designs and materials and to consider “what if” scenarios in the development phase. FEA helps minimize time and cost by optimizing a design early in the process, reducing pre-production tooling and testing. Within the simulation program, the product being evaluated is divided into “finite elements,” and model parameters such as pressure and seal lip squeeze are defined. The program then repeatedly solves equilibrium equations for each element, creating an overall picture of seal deformation, stress and contact forces (see Figure 2-24). These results can then be linked to application testing to predict performance.

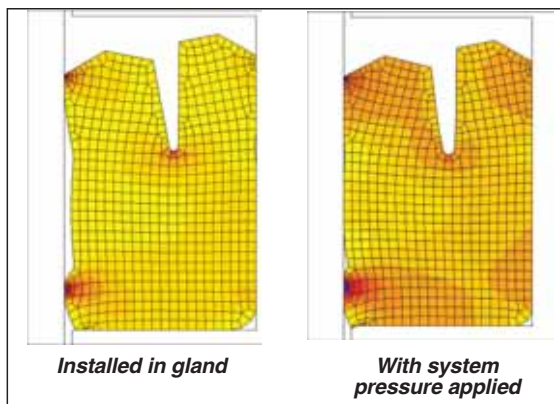

Figure 2-24

Precise material characterization is an essential component of accurately modeling elastomeric products with FEA. Due to the complex nature of elastomers, multiple tests must be performed in order to determine their behavior under stress and strain. Figure 2-25 shows the typical nonlinear stress-strain curves for elastomers compared to the linear property of steel. These nonlinear complexities make performing FEA for elastomers much more difficult than for metal materials. Advances in material characterization are continually being made to improve the ability to capture and predict thermo-viscoelastic effects of elastomers.

FEA results must be linked with lab and field testing to create a baseline to predict seal performance.

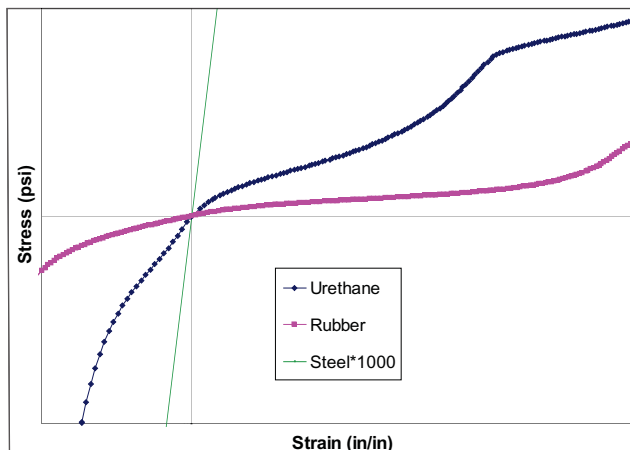

Figure 2-25. Stress/Strain relationship of steel vs. elastomers

Once this baseline is established, design iterations can be performed within FEA until the desired results are achieved and an optimum design is predicted. This evaluation process enables engineers to anticipate the performance of new seal designs by minimizing the time and cost associated with prototype tooling investments (see Figure 2-26).

Like any computer simulation, FEA has its limitations. The cost of performing FEA should always be justified by its results. FEA can provide relative information on leakage performance and wear life, but cannot give concrete answers to questions like, “Will this seal leak, and if so, how much?” and “How many cycles can be expected before failure occurs?”

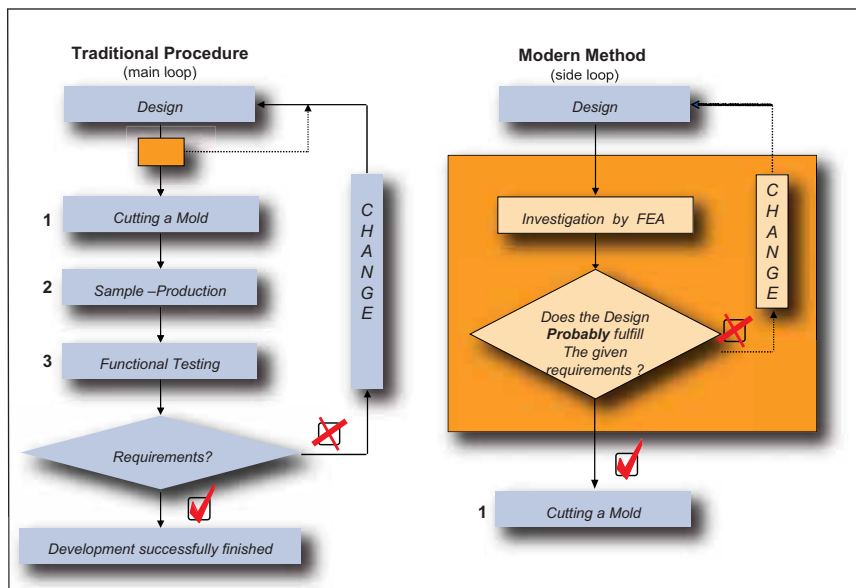

Figure 2-26. Traditional process vs. modern seal development process using FEA

## Contents

Material Classifications..... 3-1

- Thermoplastics
- Elastomers ..... 3-2
  - TPU - Polyurethanes
  - TPCE - PolyMyte
- Engineered Resins ..... 3-3
  - Nylons
  - UltraCOMP
- Thermoset Elastomers
- Rubber..... 3-4
  - Nitriles (NBR)
  - Nitroxile (XNBR)
  - Hydrogenated Nitrile (HNBR)
  - Ethylene Propylene (EPR)
  - Fluorocarbon (FKM)
- PTFE ..... 3-6
  - Non-filled PTFE
  - Filled PTFE

Typical Physical Properties..... 3-7

- Hardness ..... 3-7
- Modulus of Elasticity..... 3-8
- Ultimate Tensile Strength..... 3-8
- Ultimate Elongation ..... 3-9
- Resilience..... 3-9
- Compression Set..... 3-9

Parker Materials Typical Physical Properties

- Thermoplastics - Elastomers.... 3-11
- Thermoplastics - Resins..... 3-12
- Thermoset Elastomers ..... 3-14
- PTFE ..... 3-16
  - Energizers for PTFE seals ... 3-18
  - Back-ups for PTFE seals..... 3-19

Chemical Compatibility ..... 3-20

Temperature Limits ..... 3-20

Storage and Handling..... 3-20

## Parker engineered materials for the fluid power industry

There are two basic considerations in specifying a well-designed sealing system, both of which are equally integral to system performance: seal configuration, discussed in Section 2, and material, discussed herein. When selecting from the wide range of material options that Parker offers, there are a number of considerations to be made:

- **Typical Physical Properties**  
give a broad picture of a material's performance.
- **Chemical Compatibility**  
matches the sealing material with the system fluid and operating environment.
- **Thermal Capabilities and Extrusion Resistance**  
define limits of application parameters.
- **Friction and Wear**  
help to determine the performance and life of the seal package.
- **Storage, Handling and Installation guidelines**  
ensure seal integrity for optimal performance.

With in-house material development and compounding for thermoplastic, thermoset and PTFE materials, the ability to maintain control over all variables during the manufacturing process allows Parker to achieve optimal physical properties of its thermoplastic materials. Parker's commitment to offering the highest quality sealing materials is unsurpassed in the industry. To ensure long life and system integrity, it is critical to consider all variables in an application before specifying a material.



Materials Test Lab

## Parker EPS Material Classifications

Classes of materials offered by Parker for fluid power profiles include:

- Thermoplastics — Elastomers & Engineered Resins
- Thermoset Elastomers — Rubber (Nitrile, Nitroxile, EPR, FKM, etc.)
- PTFE — Non-filled & filled TFE materials.

**Thermoplastics**

All thermoplastics are resins designed to soften and melt when exposed to heat. Utilizing an injection molding process, thermoplastics are melted at high temperature and injected into the mold. It is then cooled causing the plastic to solidify. If high heat is introduced again, the molded part will melt. The molecules of thermoplastics are held together by physical bonds rather than chemical bonding.

3

**Elastomers — Polyurethane (TPU)**

Polyurethanes exhibits outstanding mechanical and physical properties in comparison with other elastomers. Specifically, its wear and extrusion resistance make it a popular choice for hydraulic applications. Its temperature range is generally -65°F to +200°F (-54°C to +93°C), with some compounds, such as Resilon HT, having higher temperature ratings up to +275°F (+135°C). Polyurethanes are highly resistant to petroleum oils, hydrocarbon fuels, oxygen, ozone and weathering. On the other hand, they will deteriorate quickly when exposed to acids, ketones and chlorinated hydrocarbons. Unless specifically formulated to resist hydrolysis (Resilon WR), many types of polyurethanes are sensitive to humidity and hot water. Other acronyms polyurethane may be known by are AU, EU, PU, and TPU or may simply be known as urethanes. For typical physical properties, see Table 3-1 on page 3-11.

**P4300A90 — Resilon HT**

90 Shore A hardness polyurethane manufactured by Parker specifically for sealing applications. This proprietary compound was developed to offer extended temperature capability, excellent resistance to compression set and high rebound characteristics that are unparalleled in the industry.

**P4301A90 — Resilon WR**

90 Shore A hardness polyurethane formulated for water resistance. This Parker proprietary compound can be used for both water and petroleum based fluids.

**P4304D60 — Resilon ER**

60 Shore D hardness polyurethane formulated to resist extrusion. This compound offers higher extrusion resistance for seals and anti-extrusion devices.



Figure 3-1. Resilon WR (P4301A90)

**P4311A90 — Resilon HR**

90 Shore A hardness polyurethane with high resilience. This formulation resists internal heat generated through hysteresis making this compound ideal for shock applications such as bumpers.

**P4500A90 — Polyurethane**

90 Shore A hardness polyurethane with good abrasion and extrusion resistance to improve the life of the seal. It also has excellent rebound which enhances response time to shock and side loading.

**P4615A90 & P4617D65 — Molythane**

P4615A90 is a 90 Shore A hardness, general purpose polyurethane, offering high abrasion and extrusion resistance and is an industrial standard sealing compound.

P4617D65 is a harder, 65 Shore D, version of Molythane ideal for use in anti-extrusion devices.

**P4622A90 — Ultrathane**

90 Shore A hardness polyurethane formulated with internal lubricants for lower friction to help reduce heat build-up and wear.

**P4700A90 — Polyurethane**

90 Shore A hardness polyurethane formulated to offer enhanced physical properties over Molythane with improved sealing capabilities due to lower compression set and higher rebound.

09/01/07



**P5065A88 — Low Temperature Polyurethane**

88 Shore A hardness polyether based polyurethane formulated for an improved low temperature range and higher resilience than Molythane. This compound offers a softer feel for easy installation and is a more cost effective option when compared to P4700A90.

**P6000A94 — Polyurethane**

94 Shore A hardness polyurethane formulated for an improved abrasion, extrusion, and compression set resistance, as well as higher temperature range than P4700A90.

**Elastomers — PolyMyte (TPCE)**

PolyMyte is a Parker proprietary polyester elastomer. It has exceptionally high tear strength, abrasion resistance, modulus, and a wide temperature range of -65°F to +275°F (-54°C to +135°C). PolyMyte is resistant to petroleum fluids, some phosphate ester and chlorinated fluids, common solvents and water below 180°F. It is not compatible with cresols, phenols, and highly concentrated acids. Due to its higher hardness and modulus, seals made from this material can be difficult to install. Also, care must be taken not to damage the seal lips during assembly into the gland.

**Z4651D60 — PolyMyte**

60 Shore D hardness PolyMyte is used for seals in applications requiring extended extrusion resistance and/or fluid compatibility.

**Z4652D65 — PolyMyte**

65 Shore D hardness PolyMyte is ideal for back-ups and other anti-extrusion devices.

**Z4729D55 — Hytrel®<sup>1</sup>**

Standard 55 Shore D hardness Hytrel for back-ups and other anti-extrusion devices.

**Engineered Resins**

Engineered resins such as Nylons and P.E.E.K., sometimes called hard plastics, are generally categorized as compounds with hardness measured on the Rockwell M or R scale. These compounds exhibit high tensile and compressive strength and are typically used in wear rings for bearing support and in

auxiliary devices for extrusion resistance. For typical physical properties, see Table 3-2 on page 3-12.

**Engineered Resins — Nylons****W4650 — MolyGard**

Heat stabilized, internally lubed, 30% glass-reinforced nylon for standard tolerance wear rings.

**W4655 — Nylatron®<sup>2</sup>**

Wear resistant nylon loaded with molybdenum disulfide (MoS<sub>2</sub>) for reduced friction. This compound is ideally suited for use in back-up rings. Nylatron is susceptible to water absorption.

**W4733 — WearGard**

Heat stabilized, internally lubricated, 35% glass reinforced nylon for tight-tolerance wear rings. WearGard is a dimensionally stable compound with high compressive strength and is featured in Parker's distinctive green color.

**Engineered Resins — UltraCOMP™ (PEEK)**

UltraCOMP engineered thermoplastics are semi-crystalline materials manufactured for extreme temperatures, chemicals and pressures. Their excellent fatigue resistance and stability in high temperature environments make them the material of choice where other materials fail. With a melt temperature of over 600°F, UltraCOMP can be used at continuous operating temperatures of -65° up to 500° F. Superior



Figure 3-2. UltraCOMP HTP

Draft 08/24/07

1 Hytrel® is a trademark of DuPont

2 Nylatron® is a trademark of Quadrant Engineering.



## Materials

strength and wear resistance properties make it an ideal alternative to metal or metal alloys in applications where weight, metal-to-metal wear or corrosion issues exist. Such capabilities translate into reduced equipment down time and increased productivity. For example, UltraCOMP back-up rings exhibit optimum strength-flexibility for ease of installation and high tensile strength properties for premiere extrusion resistance. UltraCOMP is available in molded geometries, machined geometries and tube stock.

3

### **W4685 — UltraCOMP HTP**

An unfilled engineered thermoplastic material specified for use in extreme conditions spanning multiple industries. Its excellent tensile strength facilitates its successful use as back-up rings and anti-extrusion devices. In addition, UltraCOMP HTP's elongation properties (>60% per ASTM D638) allow it to be flexed and twisted without breaking.

### **W4686 — UltraCOMP GF**

30% glass filled blend provides enhanced compressive strength over UltraCOMP HTP.

### **W4737 — UltraCOMP CF**

30% carbon fiber blend provides enhanced tensile and compressive strength over UltraCOMP GF.

### **W4738 — UltraCOMP CGT**

10% carbon, 10% glass, and 10% PTFE blend for enhanced compressive strength and reduced friction.

## Thermoset Elastomers - Rubber

Unlike thermoplastic elastomers, thermosetting elastomers gain their strength from an irreversible cross linking process that occurs when the compound is subjected to pressure and heat. During this process, or "cure", special chemical agents within the compound react to the heat and pressure to vulcanize the molecules together. Once cured, thermoset compounds obtain the necessary physical properties needed to function in fluid sealing applications. Reheating thermoset compounds will not cause them to melt as thermoplastics do. For typical physical properties, see Table 3-3 on page 3-14.

## Nitrile (NBR)

Nitrile rubber (NBR) is the general term for acrylonitrile butadiene copolymer. Nitrile compounds offer good resistance to abrasion, extrusion, and compression set. The acrylonitrile (ACN) content influences the physical properties of the compound. As the ACN content increases, oil and solvent resistance improve, tensile strength, hardness and abrasion resistance increase, while permeability, low temperature flexibility, and resilience decrease. Parker offers a variety of nitrile compounds, formulated with varying ACN content, to provide the best physical properties for a wide range of applications. Typical temperature ratings are -40°F to +250°F (-40°C to +121°C).



Figure 3-3. Thermoset elastomers

### **N4008A80 — NBR**

80 Shore A hardness low temperature nitrile. This is a premium, low ACN nitrile for use when low temperature sealability is the primary requirement.

### **N0304A75 — NBR**

75 Shore A hardness low temperature nitrile. This is a low ACN nitrile with an extended upper end temperature formulated for aerospace T-seal applications. N0304A75 is compliant with AMS-P-83461 which supersedes MIL-P-25732.

### **N4115A75 — NBR**

75 Shore A hardness general purpose nitrile with medium ACN content for use where a softer seal is needed.

**N4180A80 — NBR**

80 Shore A hardness general purpose nitrile with medium ACN content. N4180A80 has good chemical compatibility, sealability and moderate extrusion resistance. N4180A80 has excellent compression set resistance even at higher temperatures.

**N4181A80 — NBR**

80 Shore A hardness, medium ACN nitrile with fiber added for reinforcement. The fibers also help to retain lubrication for reduced friction. N4181A80 is often used in the 8600 wiper seal to resist extrusion.

**N4121A90 — NBR**

90 Shore A hardness, high ACN nitrile with an exceptionally high modulus which gives this compound outstanding extrusion resistance. N4121A90 also has good compression set properties.

**Nitroxile™ (Carboxylated Nitrile) (XNBR)**

Carboxylated nitriles are formed by exposing nitrile polymer to carboxylic acid groups during polymerization. This forms an improvement over nitrile by producing a more wear resistant seal compound with enhanced modulus and tensile strength. Nitroxile offers exceptionally low friction characteristics and has excellent resistance to petroleum oils, hydrocarbon fuels and water. The typical temperature range for Nitroxile is -10°F to +250°F (-23°C to +121°C).

**N4257A85 — XNBR**

85 Shore A hardness carboxylated nitrile that has an internal lubricant as an aid to reduce friction. It is ideal for pneumatic applications with excellent compression set properties.

**N4274A85 — XNBR**

85 Shore A hardness carboxylated nitrile that is formulated with a proprietary internal lubricant for exceptionally low friction operation. This is the premier carboxylated nitrile in the sealing industry.

**N4263A90 — XNBR**

90 Shore A hardness carboxylated nitrile that is formulated for increased hardness, modulus and tensile strength to provide extra toughness in applications requiring nitrile seals. This compound has excellent resistance to extrusion, explosive decompression and abrasion.

**Hydrogenated Nitrile (HNBR)**

Hydrogenated nitrile offers improved chemical compatibility and heat resistance over standard nitrile by using hydrogen in the formulation to saturate the backbone of the nitrile molecule. However, the compound usually becomes less flexible at low temperatures. This can be offset to some degree by adjusting the ACN content as is done with NBR. Typical temperature ratings are -25°F to +320°F (-32°C to +160°C).

**N4032A80 (KB162)<sup>3</sup> — HNBR**

80 Shore A hardness hydrogenated nitrile.

**N4031A85 (KB183) — HNBR**

85 Shore A hardness hydrogenated nitrile formulated for low temperatures.

**N4033A90 (KB163) — HNBR**

90 Shore A hardness hydrogenated nitrile formulated for improved chemical compatibility.

**N4007A90 — HNBR**

90 Shore A hardness hydrogenated nitrile featuring excellent resistance to extrusion and explosive decompression to meet Norsok M-710.

**Ethylene Propylene (EPR)**

Ethylene propylene has excellent dimensional stability in water-based fluids and steam; however, it should never be exposed to petroleum lubricants, water / oil emulsions, solvents or other petroleum based fluids (CAUTION! Do not lubricate the seals with petroleum oils or greases during installation). Ethylene propylene rubber is compatible with Skydrol<sup>®4</sup> and other phosphate ester fluids used in aircraft hydraulic systems. EPR is also the recommended seal material for automotive brake fluids (DOT 3, 4 and 5) as well as many commercial refrigerants. Ethylene propylene rubber is also useful in sealing weak alkalis, acids, and methyl ethyl ketone (MEK). The typical temperature range is -65°F to +300°F (-54°C to +149°C).

3 Compound numbers in parenthesis refer to Parker Seal Group material numbers.

4 Skydrol<sup>®</sup> is a registered trademark of Solutia Inc.

## Materials

### E4259A80 — EPR

80 Shore A hardness general purpose EPR with excellent dimensional stability in water-based fluids and steam. This compound has excellent chemical compatibility and compression set resistance.

### E4207A90 — EPR

90 Shore A hardness general purpose EPR with excellent dimensional stability in water-based fluids and steam. With its additional hardness it is able to be used at higher pressures than the 80 Durometer compounds. It has excellent compression set properties as well as excellent compatibility with such fluids as DOT 3 brake fluid.

### E4270A90 — EPR

90 Shore A hardness EPR formulated for steam/geothermal environments with an upper temperature range of +600°F (+315°C). Excellent compression set resistance.

### Fluorocarbon Elastomers (FKM)

Fluorocarbon elastomers are highly specialized polymers that show the best resistance of all rubbers to chemical attack, heat and solvents. FKM is of critical importance in solving problems in aerospace, automotive, chemical and petroleum industries. FKM is suitable for use in most hydraulic fluids except Skydrol® types and ester-ether fluids. Standard temperatures range from -20°F to +400°F (-29°C to +204°C).

### V4205A75 — FKM

75 Shore A hardness general purpose fluorocarbon.

### V1289A75 — FKM

75 Shore A hardness fluorocarbon formulated for improved low temperature performance of -40°F to +400°F (-40°C to +204°C).

### V4208A90 — FKM

90 Shore A hardness general purpose fluorocarbon.

### V4266A95 — FKM

95 Shore A hardness extended wear and extrusion resistant fluorocarbon.



Figure 3-4. PTFE

### PTFE

PTFE (Polytetrafluoroethylene) offers the following characteristics over thermoplastic and thermoset compounds, making it a unique problem solving solution for sealing applications:

- Low coefficient of friction  
The low coefficient of friction (.06) of PTFE material results from low interfacial forces between its surface and other materials that come in contact. This behavior of PTFE material eliminates any possibility of stick-slip effects in dynamic sealing applications.
- Wide temperature range  
PTFE's high melting point and morphological characteristics allow components made from the resin to be used continuously at service temperatures to 600°F (315°C). For sealing cryogenic fluids below -450°F (-268°C), special designs using PTFE and other fluoropolymers are available.
- Chemically inert
- Dry running capability
- Resist temperature cycling
- High surface speeds
- Low water absorption
- Low dielectric constant and dissipation factor

### Enhancing Performance of PTFE with Fillers

In fluid power applications, it can be beneficial to add fillers to PTFE compounds in order to enhance its physical characteristics. Specific fillers can be incorporated to provide improved compression strength, wear, creep and extrusion resistance.

**Non-Filled PTFE****0100 — Virgin PTFE**

Virgin PTFE has no fillers and is considered FDA and potable water safe.

**Filled PTFE****0102 — Modified Virgin PTFE**

Virgin PTFE modified with custom pigmentation features similar basic properties as virgin, but offers increased wear and creep resistance and lower gas permeability.

**0120 — Mineral Filled**

Mineral is ideal for improved higher temperatures and offers low abrasion to soft surfaces. PTFE with this filler can easily be qualified to FDA and other food-grade specifications.

**0203 — Fiberglass Filled**

Glass fiber is the most common filler with a positive impact on creep performance of PTFE. Glass fiber adds wear resistance and offers good compression strength.

**0204 / 0205 — Molybdenum Disulfide and Fiberglass Filled**

Molybdenum disulfide ( $\text{MoS}_2$ ) increases the hardness of the seal surface while decreasing friction. It is normally used in small proportions and combined with other fillers such as glass.  $\text{MoS}_2$  is inert towards most chemicals.

**0301 — Graphite Filled**

Graphite filled PTFE has an extremely low coefficient of friction due to the low friction characteristics of graphite. Graphite is chemically inert. Graphite imparts excellent wear properties and high PV values to PTFE.

**0307 — Carbon-Graphite Filled**

Carbon reduces creep, increases hardness and elevates the thermal conductivity of PTFE. Carbon-graphite compounds have good wear resistance and perform well in non-lubricated applications.

**0401 / 0402 — Bronze Filled**

Bronze is a self lubricated, long-wearing material that offers superior frictional characteristics and high temperature capabilities.

**0501 / 0502 — Carbon Fiber Filled**

Carbon fiber lowers creep, increases flex and compressive modulus and raises hardness. Coefficient of thermal expansion is lowered and thermal conductivity is higher for compounds of carbon fiber filled PTFE. This is ideal for automotive applications in shock absorbers and water pumps.

**0601 — Aromatic Polyester Filled**

Aromatic polyester is excellent for high temperatures and has excellent wear resistance against soft, dynamic surfaces. This filler is not recommended for sealing applications involving steam.



## Typical Physical Property Information

There are six significant typical physical properties that affect seal performance. It is important to understand how the physical properties of a compound relate to each sealing application and to know that the fluid being sealed may change these original characteristics. The six critical properties identified below each show detail concerning their impact on sealing as well as measurement techniques.

3

### 1 — Hardness.

Hardness, also referred to as durometer, is a property frequently associated with extrusion resistance (see Table 2-4 on page 2-5). It is not a good indication of extrusion resistance when comparing different material classifications. For example, a polyurethane and a nitrile compound with the same hardness will not share the same extrusion resistance. Hardness also relates to low pressure sealability, since the ability of a seal to conform to a mating surface depends, to a high degree, on the hardness of the material. The harder a material, the less it will conform to a sealing surface at low pressure. As hardness increases, modulus and compressive strengths typically increase as well. This means that harder seals are typically more difficult to install and often have greater friction.

Hardness is measured by how easily a specified surface is deformed by an indenter. “Shore A” and “Shore D” are the two most common scales for seal materials. Both scales use a rounded indenter to impact the surface being measured. Shore A is typically used to measure softer materials, while harder materials are measured on the Shore D scale. Although the Shore A scale has a max value of 100, it is recommended to switch to the Shore D scale past 95 Shore A. These two scales overlap one another as shown in Figure 3-5.

Standardized test methods for this physical property are ASTM 2240 and DIN 53505, which corresponds to ISO 48. This test procedure has a repeatability of  $\pm 5$  points, because its accuracy is dependant on the flatness of the specimen and the skill of the technician. For this reason, measuring material hardness on a seal itself, with its irregular surface, is discouraged and can only be used with caution as a relative value.

A second method of measuring hardness that is seldom used and is only presented here for informational purposes is the International Rubber Hardness Degree (IRHD), as described in ASTM

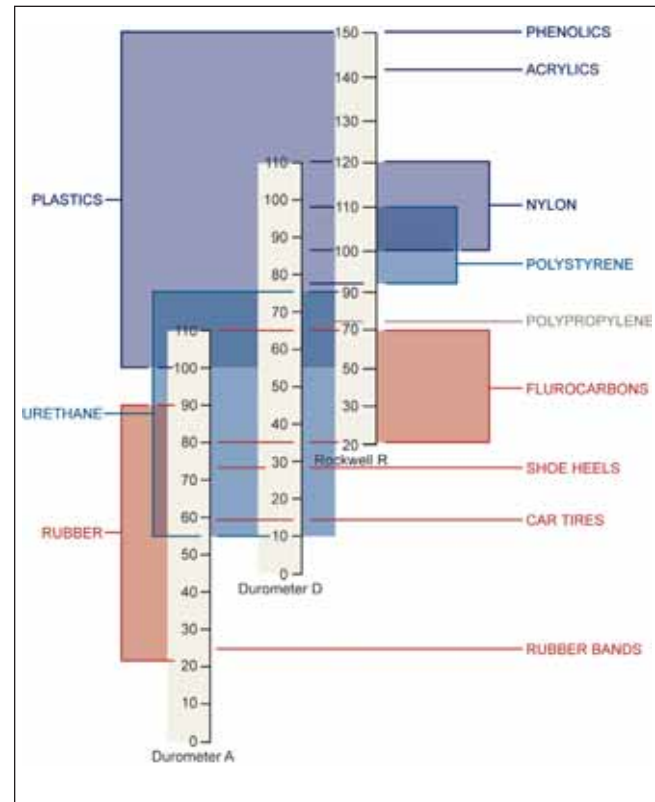

Figure 3-5. Hardness Scale Comparison Between Shore A, Shore D, and Rockwell R

1414/1415, Din 53519, and ISO 1400/1818. The IRHD and Shore methods do not provide comparable values and should not be used to relate one material to another.

### 2 — Modulus

Modulus is truly what gives a seal material its extrusion resistance. It is a measure of the force required to stretch an elastomer a certain percentage of its original length. Modulus of a material can more simply be thought of as its stiffness and is also an indication of the ease of installation. Higher modulus materials resist stretching and compression, increasing installation difficulty. (ASTM method D412)

### 3 — Ultimate Tensile Strength

Ultimate tensile strength is closely related to wear resistance, toughness and therefore service life of the seal. This property is the amount of force required to reach ultimate elongation, physically breaking the material. Polyurethane and filled PTFE compounds generally have very high tensile strength, providing the associated excellent tear and abrasion resistance.

09/01/07



Modulus of Elasticity measures the force per area to stretch a sample to a certain percentage of its original length.



Example: To stretch a 1 inch sample to 2 inches, is a 100% stretch.

Figure 3-6. Modulus of Elasticity

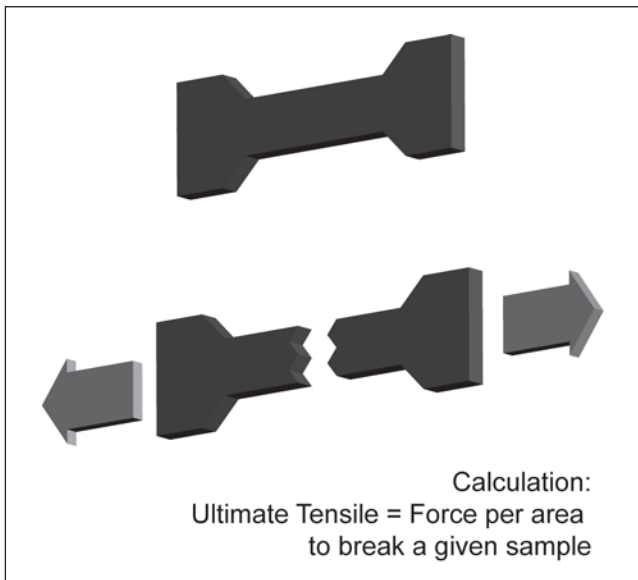

Calculation:  
Ultimate Tensile = Force per area  
to break a given sample

Figure 3-7. Tensile Strength

Most rubber compounds have much lower tensile strength values, often resulting in one fifth the wear life of higher tensile materials. (ASTM method D412 and DIN 53504) *It should be noted that values obtained from the DIN standard are typically higher than those from the ASTM standard as there is a difference in the test specimen and the pull rate.*

#### 4 — Ultimate Elongation

Ultimate elongation is most closely associated with installation, but can also be a good indicator of chemical compatibility. This property is the distance a material will stretch before breaking, expressed as a percentage of its original length. It can be important in

small diameter seals because it can limit the amount of stretch available for installation. Elongation is also a good indicator of chemical compatibility. If changes are observed after a material sample is soaked in a fluid, it is possible that the seal is being adversely affected. In this situation, the fluid will typically attack and break the polymeric chain, reducing the ultimate elongation. (ASTM method D412)

#### 5 — Resilience

Resilience, also known as rebound, strongly correlates to how quickly a seal will respond to changing conditions in a dynamic environment. This property measures the ability of a material to return to its original shape after being deformed, as well as the speed at which it can achieve this.

Examples of conditions that require seals to exhibit excellent resilience are out-of-round cylinders and rapid side loading situations that cause the rod to move sideways quickly. Applications with high vibration or high stroke speed can also benefit from high resiliency seals. (ASTM method D2632, DIN 53512)

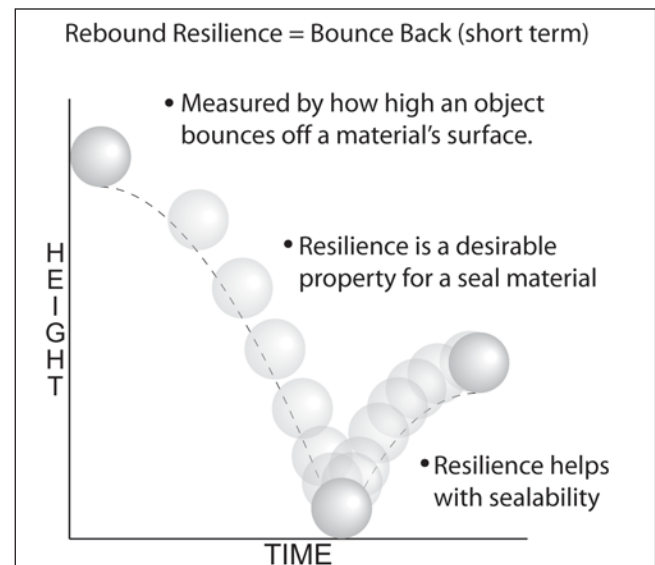

Figure 3-8. Rebound Resilience

#### 6 — Compression Set

Compression set is the inability of a seal to return to its original shape after being compressed. It is associated with a sealing material's "long-term memory" and is considered to be one of the most critical properties of the seal. For a seal to maintain

**Materials**

radial pressure and establish a continuous sealing line, it must resist stress relaxation during the time and at the temperature to which it is exposed. As the seal begins to take a compression set, it loses its inherent ability to seal and may require other influences to maintain a positive sealing force. Examples of such factors would be system pressure or an expander working to energize the sealing lips. The lowest possible compression set value is always advantageous because it represents the least amount of lost sealing force over time.

As defined by ASTM, compression set is the percent of deflection by which the seal fails to recover after a specific deflection, time and temperature (see Fig. 3-9). When comparing compression set values between two materials, it is important to note both the time and temperature of the tests being compared. Even though a typical compression set value is based on a 70 hour period, many times a 22 hour period may be used for time and convenience sake. A 22 hour compression set value will always be dramatically better than that of a 70 hour test under the same temperature condition. It is also important to know that each elastomer family is generally tested at a different temperature or series of temperatures. Be sure that the temperatures of the test data closely approximate the temperature the seal will be used in. (ASTM method D395, DIN 53517)

**Parker Materials Typical Physical Properties**

Typical physical properties for Parker fluid power product materials are shown in the corresponding tables:

Material Classification		Table (page)
Thermoplastics		
Elastomers		Table 3-1, (pg 3-11)
	TPU Polyurethanes	
	TPCE PolyMyte	
Engineered Resins		Table 3-2, (pgs. 3-12, 3-13)
	Nylons UltraCOMP	
Thermoset Elastomers		
	Rubber Nitriles Nitroxile Ethylene Propylene Fluorocarbon	Table 3-3 (pgs. 3-14, 3-15)
PTFE for Fluid Power Seals		
	Non-filled PTFE Filled PTFE	Table 3-4 (pgs. 3-16, 3-17)
	Rubber energizer materials for PTFE fluid power seals	Table 3-5 (pg 3-18)
	Back-up ring materials for PTFE fluid power seals	Table 3-6 (pg 3-19)

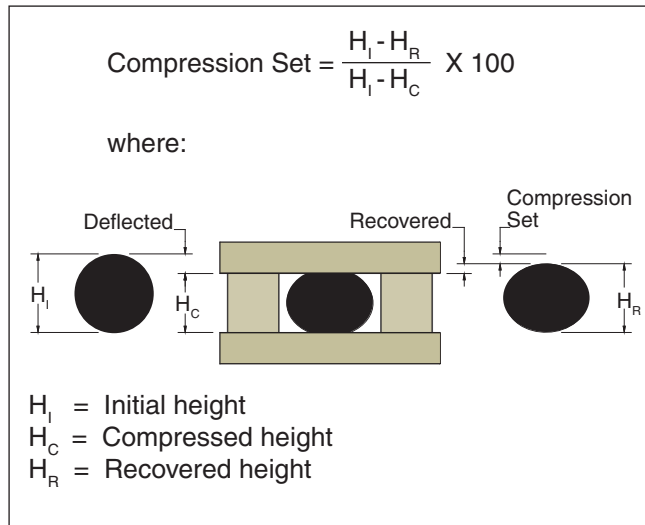

*Figure 3-9. Compression set calculation*

Table 3-1. Typical Physical Properties: Thermoplastics — Elastomers

Parker Material Code	Material Trade Name (Color)	Typical Applications & Description	Service Temperature Range °F (°C)	Tensile Strength at Break psi (MPa)	Ultimate Elongation	Shore Hardness		100% Modulus psi (MPa)	Compression Set		Rebound	Abrasion Rating Best = 10
						A	D		Set	at°F (°C)		
Thermoplastic Elastomers — TPU, Polyurethanes												
P4300A90	Polyurethane Resilon HT (Tan)	Proprietary compound offering extended temperature range, high rebound.	-65 to +275 (-54 to +135)	8625 (59.5)	560%	92	-	1793 (12.4)	28.9%	212 (100)	63%	10
P4301A90	Polyurethane Resilon WR (Aqua Blue)	For water or petroleum based fluids.	-35 to 225 (-37 to +107)	7129 (49.2)	514%	90	-	2029 (13.9)	24.8%	158 (70)	45%	8.1
P4304D60	Polyurethane Resilon ER (Brown)	Offers higher extrusion resistance for seals and anti-extrusion devices.	-65 to +275 (-54 to +135)	6521 (44.9)	556%	-	55	2940 (20.3)	32.2%	158 (70)	46%	7.3
P4311A90	Polyurethane Resilon HR (Red)	Formulation resists internal heat generated through hysteresis, ideal for shock applications.	-65 to +275 (-54 to +135)	7229 (49.8)	632%	91	-	1732 (11.9)	33.3%	212 (100)	63%	8.2
P4615A90	Polyurethane Molythane (Black)	General purpose industrial polyurethane offering high abrasion resistance	-65 to +200 (-54 to +93)	8134 (56.1)	565%	95	-	1755 (12.1)	30.8%	158 (70)	34%	9.4
P4617D65	Polyurethane Molythane (Black)	General purpose industrial polyurethane offering high extrusion resistance.	-65 to +250 (-54 to +121)	5973 (41.2)	544%	-	62	3914 (26.9)	-	-	-	6.7
P4622A90	Polyurethane Ultrathane (Yellow)	Formulated with internal lubricants for lower friction to help reduce heat build up.	-65 to +225 (-54 to +107)	6757 (46.6)	466%	94	-	1755 (12.1)	31.0%	158 (70)	34%	7.6
P4500A90	Polyurethane (Light Green)	Offers good abrasion and extrusion resistance with excellent rebound.	-65 to +200 (-54 to +93)	6740 (46.5)	586%	92	-	1774 (12.2)	32.9%	158 (70)	42%	7.6
P4700A90	Polyurethane (Green)	Enhanced properties over 4615 to improve sealing capabilities from lower compression set.	-65 to +200 (-54 to +93)	5660 (39.0)	511%	92	-	1665 (11.5)	24.7%	158 (70)	35%	6.3
P5065A88	Polyurethane (Dark Blue)	Formulated for an improved low temperature range and higher resilience than 4615.	-70 to +200 (57 to +93)	5033 (34.7)	660%	86	-	1073 (7.4)	27.2%	158 (70)	50%	5.5
P6000A90	Polyurethane (Dark Gray)	Improved abrasion, extrusion and compression resistance as well as higher temp. than 4700.	-31 to +230 (-35 to +110)	6513 (44.9)	491%	93	-	1941 (13.4)	26.2%	158 (70)	44%	7.3
Thermoplastic Elastomers — TPCE, PolyMyte												
Z4651D60	PolyMyte (Orange)	Used in applications requiring extended extrusion resistance and fluid compatibility.	-65 to +275 (-54 to +135)	5748 (39.6)	775%	-	58	2231 (15.4)	43.0%	158 (70)	-	6.4
Z4652D65	PolyMyte (Orange)	Primarily used for back-up rings and other anti-extrusion devices.	-65 to +275 (-54 to +135)	6175 (42.6)	700%	-	62	2611 (18.0)	45.4%	158 (70)	-	6.9
Z4729D55	Hytrell (Tan)	Primarily used for back-up rings and other anti-extrusion devices.	-65 to +275 (-54 to +135)	5609 (38.7)	837%	-	56	2212 (15.2)	46.0%	158 (70)	-	6.9

09/01/07

**Materials****Table 3-2. Typical Physical Properties: Thermoplastics — Engineered Resins**

Parker Material Code	Material	Color	Typical Applications & Description	Service Temperature Range °F (°C)	Tensile Strength at Break psi (MPa)	Flexural Strength Kpsi (MPa)
Nylons						
W4650	MolyGard	Gray	Heat stabilized, internally lubed 30% glass-reinforced nylon for standard tolerance wear rings.	-65 to +275 (-54 to +135)	17500 (121.0)	22600 (156.0)
W4655	Nylatron	Gray	Wear resistant nylon with molybdenum disulfide for lower friction, suited for back-up rings.	-65 to +275 (-54 to +135)	13000 (89.6)	16000 (110.3)
W4733	WearGard	Green	High compressive strength, 35% glass-reinforced nylon for tight tolerance wear rings.	-65 to +275 (-54 to +135)	18300 (126.0)	25500 (176.0)
UltraCOMP						
W4685	UltraCOMP HTP	Tan	A homogenous engineered thermoplastic used for extreme conditions in many markets.	-65 to +500 (-54 to +260)	14000 (97.0)	23600 (163.0)
W4686	UltraCOMP GF	Tan	30% glass filled engineered thermoplastic with enhanced compressive strength.	-65 to +500 (-54 to +260)	22600 (156.0)	30700 (212.0)
W4737	UltraCOMP CF	Black	30% carbon fiber blend, provides enhanced tensile and compressive strength.	-65 to +500 (-54 to +260)	32400 (224.0)	43200 (298.0)
W4738	UltraCOMP CGT	Gray	Thermoplastic material blended with carbon, glass and PTFE for reduced friction.	-65 to +500 (-54 to +260)	20400 (141.0)	26900 (186.0)
Composite Resins						
0871-0874	Composite Fabric-Reinforced Resins	Multiple	Fabric-reinforced resins to handle severe sideloads, high heat and swell from moisture.	-40 to +250 (-40 to +121)	9500 (65.5)	-

3

Table 3-2. Typical Physical Properties: Thermoplastics — Engineered Resins (cont'd)

Parker Material Code	Rockwell Hardness		Notched IZOD Impact Strength Ft-Lbs/In.	Tensile Modulus Kpsi (MPa)	Shear Strength psi (MPa)	Flexural Modulus Kpsi (MPa)	Compressive Strength psi (MPa)	Permissible Compressive Load psi (MPa)	Water Absorption (24 Hour) %
	M	R							
Nylons									
W4650	77	114	1.37	952 (6.6)	9390 (65.0)	860 (5929.0)	21000 (145.0)	21700 (150.0)	0.80
W4655	-	119	1.69	536 (3.7)	9,500 (65.5)	406 (2.8)	12000 (82.7)	-	0.50
W4733	87	117	1.15	899 (6.2)	9820 (68.0)	1,100 (7584.0)	21500 (148.0)	21700 (150.0)	
UltraCOMP									
W4685	-	126	2	507 (3.5)	7687 (53.0)	579 (4.0)	17100 (118.0)	-	0.50
W4686	-	124	2	1653 (114.0)	14068 (97.0)	1334 (9.2)	31100 (215.0)	-	0.11
W4737	-	124	2	3234 (22.3)	12328 (85.0)	2697 (18.6)	34800 (240.0)	-	0.06
W4738	-	100	2	1464 (10.1)	-	1189 (8.2)	21700 (150.0)	-	0.06
Composite Resins									
0871-0874	100	-	10	470 (3.24)	-	280 (1.9)	35000 (241.3)	65200 (449.54)	0.10



Table 3-3. Typical Physical Properties — Thermoset Elastomers

Parker Material Code	Material	Color	Typical Applications & Description	Service Temperature Range °F (°C)	Tensile Strength at Break psi (MPa)	Ultimate Elongation	Shore A Hardness	100% Modulus psi (MPa)	Compression Set		Abrasion Rating (1) Worst to (10) Best
									Set	at°F (°C)	
Nitrile (NBR)											
N4115A75	Nitrile	Black	General purpose nitrile with medium ACN content for use where a softer seal is required.	-40 to +225 (-40 to +107)	2215 (15.3)	328%	74	641 (4.4)	23.6%	212 (100)	1.9
N4180A80	Nitrile	Black	General purpose nitrile with good chemical compatibility, seal ability and compression set.	-40 to +250 (-40 to +121)	2199 (15.2)	275%	80	1007 (6.9)	19.4%	302 (150)	1.9
N4181A80	Flocked Nitrile	Black	Fiber added reinforcement helps retain lubrication for reduced friction. Used in 8600 wipers.	-40 to +250 (-40 to +121)	2437 (16.8)	345%	80	663 (4.6)	19.4%	302 (150)	2.2
N4121A90	Nitrile	Black	High modulus for outstanding extrusion resistance plus good compression set.	-40 to +250 (-40 to +121)	2415 (16.7)	247%	89	1447 (9.9)	24.0%	212 (100)	2.2
N4008A80	Nitrile	Black	Premium, low ACN nitrile for use when low temperature sealability is required.	-70 to +275 (-57 to +135)	2141 (14.8)	177%	79	1031 (7.1)	26.4%	212 (100)	1.8
N0304A75	Nitrile	Black	Extended temperature range formulated for aerospace T-seal applications.	-65 to +275 (-54 to +135)	1790 (12.3)	213%	75	567 (3.9)	19.4%	212 (100)	1.4
Carboxylated Nitroxile (XNBR)											
N4257A85	Nitroxile	Black	XNBR with internal lubricant to reduce friction. Ideal for pneumatic applications.	0 to +250 (-18 to +121)	2845 (19.6)	249%	80	1223 (8.4)	20.0%	212 (100)	2.7
N4274A85	Nitroxile	Black	Premier XNBR in the industry formulated with proprietary internal lubricant.	-10 to +250 (-23 to +121)	3016 (20.8)	241%	83	1404 (9.7)	31.0%	212 (100)	2.9
N4263A90	Nitroxile	Black	Extra tough XNBR with increased hardness, modulus and tensile strength.	-20 to +275 (-29 to +135)	3103 (21.4)	117%	90	2902 (20.0)	26.4%	212 (100)	3
Hydrogenated Nitrile (HNBR)											
N4031A85 (KA183)	HNBR	Black	Equivalent to Seal Group compound KB183A85, offers low temperature improvement.	-40 to +320 (-40 to +160)	1800 (12.4)	100%	88	1500 (10.3)	25.0%	212 (100)	1.4
N4032A80 (KB162)	HNBR	Black	Equivalent to Seal Group compound KB162A80 offering improved chemical compatibility.	-25 to +320 (-32 to +160)	3335 (22.9)	164%	82	2358 (16.3)	23.0%	302 (150)	3.3
N4033A90 (KB163)	HNBR	Black	Equivalent to Seal Group compound KB163A90 offering improved chemical compatibility	-25 to +320 (-32 to +160)	3219 (22.2)	107%	88	3329 (22.9)	22.0%	302 (150)	3.2
N4007A90	HNBR	Black	Excellent extrusion resistance and explosive decompression to meet Norsok M-710	-20 to +320 (-29 to +160)	4698 (32.4)	207%	92	2006 (13.8)	14.9%	212 (100)	5.0

09/01/07

Table 3-3. Typical Physical Properties — Thermoset Elastomers (cont'd)

Parker Material Code	Material	Color	Typical Applications & Description	Service Temperature Range°F (°C)	Tensile Strength at Break psi (MPa)	Ultimate Elongation	Shore A Hardness	100% Modulus psi (MPa)	Compression Set		Abrasion Rating (1) Worst to (10) Best
									Set	at°F (°C)	
Ethylene Propylene (EPR)											
E4207A90	Ethylene Propylene	Black	General purpose 90A EPR, has excellent dimensional stability in water-based fluids and steam.	-65 to +300 (-54 to +149)	2285 (15.8)	135%	87	1453 (10.0)	13.0%	257 (125)	2.0
E4259A80	Ethylene Propylene	Black	General purpose 80A EPR, has excellent dimensional stability in water-based fluids and steam.	-65 to +300 (-54 to +149)	2142 (14.8)	162%	79	1057 (7.3)	12.8%	257 (125)	1.8
E4270A90	Ethylene Propylene	Black	Formulated for geothermal environments and steam up to +600°F.	-65 to +400 (-54 to +204)	3047 (21.0)	145%	89	1800 (12.4)	27.1%	302 (150)	3.0
Fluorocarbon Elastomers (FKM)											
V1289A75	Fluoro-elastomer	Black	Fluorocarbon material formulated for improved low temperature applications.	-40 to +400 (-40 to +204)	1497 (10.3)	163%	78	920 (6.3)	17.0%	392 (200)	1.0
V4205A75	Fluoro-elastomer	Black	70 Shore A general purpose fluorocarbon resistant to chemical attack and heat.	-20 to +400 (-29 to +204)	2161 (14.9)	202%	76	803 (5.5)	6.5%	302 (150)	1.8
V4208A90	Fluoro-elastomer	Black	90 Shore A general purpose fluorocarbon resistant to chemical attack and heat.	-5 to +400 (-21 to +204)	1954 (13.5)	152%	90	1327 (9.2)	13.4%	302 (150)	1.6
V4266A95	Fluoro-elastomer	Black	Features extended wear and extrusion resistance over general purpose fluorocarbons.	-5 to +400 (-21 to +204)	2442 (16.8)	102%	92	2210 (15.2)	17.6%	302 (150)	2.2

## Materials

Table 3-4. Typical Physical Properties — PTFE

Parker Material Code	Material	Color	Typical Applications & Description	Service Temperature Range °F (°C)	Tensile Strength in psi at Break (bar)	Elongation in %	Hardness Shore D
Non-Filled PTFE							
0100	Virgin PTFE	White	Excellent for cryogenic applications. Good for gases.	-425 to 450 (-254 to 233)	4575 (316)	400	60
Filled PTFE							
0102	Modified PTFE	Turquoise	Lower creep, reduced permeability and good wear resistance.	-320 to 450 (-195 to 282)	4600 (317)	390	60
0120	Mineral Filled PTFE	White	Excellent low abrasion to soft surfaces & improved upper temperature performances. FDA materials.	-360 to 550 (-218 to 288)	4070 (281)	270	65
0203	Fiberglass Filled PTFE	Gold	Excellent compressive strength and good wear resistance.	-200 to 575 (-129 to 302)	3480 (240)	190	67
0204	Fiberglass & Moly Filled PTFE	Gray	Excellent for extreme conditions such as high pressure , temperature and longer wear life on hardened dynamic surfaces.	-200 to 575 (-129 to 302)	3100 (214)	245	62
0205	Fiberglass & Moly Filled PTFE	Gray	Improved compressive strength and wear in rotary applications	-200 to 575 (-129 to 302)	3480 (240)	190	67
0301	Graphite Filled PTFE	Black	Excellent for corrosive service. Low abrasion to soft shafts. Good in unlubricated service.	-250 to 550 (-157 to 288)	3200 (221)	260	60
0307	Carbon-Graphite Filled PTFE	Black	Excellent wear resistance and reduces creep.	-360 to 575 (-218 to 302)	2250 (155)	100	64
0401	Bronze Filled PTFE	Bronze	Excellent extrusion resistance and high compressive loads.	-200 to 575 (-129 to 302)	3200 (221)	250	63
0502	Carbon Fiber Filled PTFE	Brown	Good for strong alkali and hydrofluoric acid. Good in water service.	-200 to 550 (-129 to 288)	3200 (221)	312	60
0601	Aromatic Polyester Filled PTFE	Tan	Excellent high temperature capabilities and excellent wear resistance.	-200 to 575 (-129 to 302)	2500 (172)	200	61

09/01/07



Table 3-4. Typical Physical Properties — PTFE (cont'd)

Parker Material Code	Coefficient of Friction	Thermal Conductivity (in W/mK)	Coefficient of Thermal Expansion (in/in/°F x 10 <sup>-5</sup> at 203°F)	Permanent Deformation Under Load (70°F 2000 psi in %)	Chemical Compatibility Rating	Wear Resistance Rating	High Pressure Extrusion Resistance Rating	FDA/NSF Compliant
Non-Filled PTFE								
0100	0.05 - 0.10	0.30	11	7.0	5	1	1	Y
Filled PTFE								
0102	0.05 - 0.10	0.29	11	6.9	5	2	2	Y
0120	0.08 - 0.12	0.23	11	4.2	5	3	4	Y
0203	0.08 - 0.12	0.27	10	6.0	5	5	5	N
0204	0.08 - 0.12	0.28	11	6.0	5	4	4	N
0205	0.08 - 0.12	0.27	10	6.0	5	5	5	N
0301	0.07 - 0.09	0.39	11	3.5	5	4	3	N
0307	0.08 - 0.11	0.35	8	2.5	5	4	4	N
0401	0.18 - 0.22	0.45	10	4.4	4	4	4	N
0502	0.09 - 0.12	0.31	13	1.8	4	5	5	N
0601	0.09 - 0.13	0.32	9	5.5	4	4	4	N

**Note: We emphasize that this tabulation should be used as a guide only.**

The above data is based primarily on laboratory and service tests, but does not take into account all variables that can be encountered in actual use. Therefore, it is always advisable to test the material under actual service conditions before specifying. If this is not practical, tests should be devised that simulate service conditions as closely as possible.

Parker also offers unique material blends and recipes along with a wide variety of other PTFE filler combinations and colors to enhance seal performance in the most extreme application needs. For guidance on material selection for extreme applications, please contact Application Engineering at 801-972-3000.

09/01/07



## Materials

The following table lists material codes that apply to the rubber energizer used with PTFE fluid power seals. List the corresponding material code in the appropriate location in the part number. Parker has a full range of rubber compounds to suit various temperature, pressure and chemical compatibility requirements. If your application requires an alternate rubber compound, not listed, please consult a Parker application engineer.

**Table 3-5. Typical Application Ranges & Recommendations — Rubber Energizers for PTFE fluid power seals**

Material Code	Material Description	Shore A Hardness	Temperature Range	Recommended Use	Not Recommend For Use
A	Nitrile (NBR)	70	-30°F to 250°F (-34°C to 121°C)	<ul style="list-style-type: none"> <li>Petroleum oils and fluids</li> <li>Diesel fuel and fuel oils</li> <li>Cold water</li> <li>Silicone oil and grease</li> <li>Mineral oil and grease</li> <li>Vegetable oil</li> <li>HFA, HFB and HFC fluids</li> </ul>	<ul style="list-style-type: none"> <li>Aromatic hydrocarbons</li> <li>Chlorinated hydrocarbons</li> <li>Polar solvents (MEK, ketone, acetone)</li> <li>Phosphate ester fluids</li> <li>Strong acids</li> <li>Automotive brake fluid</li> </ul>
B	Low Temperature Nitrile (NBR)	75	-65°F to 225°F (-55°C to 107°C)		
C	Clean Grade Nitrile (NBR)	70	-30°F to 250°F (-34°C to 121°C)		
D	Hydrogenated Nitrile (HNBR)	70	-23°F to 300°F (-32°C to 149°C)		
F	Fluorocarbon (FKM)	70	-15°F to 400°F (-26°C to 205°C)	<ul style="list-style-type: none"> <li>Petroleum oils and fluids</li> <li>Cold water</li> <li>Silicone greases and oils</li> <li>Aliphatic hydrocarbons</li> <li>Aromatic hydrocarbons</li> <li>Fuels</li> <li>Fuels with methanol content</li> </ul>	<ul style="list-style-type: none"> <li>Glycol based brake fluids</li> <li>Ammonia gas, amines, alkalis</li> <li>Superheated steam</li> <li>Low molecular organic acids</li> </ul>
H	Silicone HT (VMQ)	70	-65°F to 450°F (-55°C to 232°C)	<ul style="list-style-type: none"> <li>Engine and transmission oil</li> <li>Animal and vegetable oil and grease</li> <li>Brake fluid</li> <li>Fire-resistant hydraulic fluid</li> <li>Ozone, aging and weather resistant</li> </ul>	<ul style="list-style-type: none"> <li>Superheated steam</li> <li>Acids and Alkalis</li> <li>Aromatic mineral oil</li> <li>Hydrocarbon-based fuels</li> <li>Aromatic hydrocarbons</li> </ul>
K	Ethylene Propylene Rubber (EPDM)	70	-70°F to 250°F (-57°C to 121°C)	<ul style="list-style-type: none"> <li>Hot water</li> <li>Glycol based brake fluids</li> <li>Many organic and inorganic acids</li> <li>Cleaning agents</li> <li>Soda and potassium alkalis</li> <li>Phosphate ester based fluids</li> <li>Many polar solvents</li> </ul>	<ul style="list-style-type: none"> <li>Petroleum oils and fluids</li> <li>Mineral oil products</li> </ul>
L	Ethylene Propylene Rubber (EPDM)	80	-70°F to 250°F (-57°C to 121°C)		

09/01/07





The following table is a list of back up ring materials for use with PTFE fluid power seals. List the corresponding back up ring material code in the appropriate location in the part number.

**Table 3-6. Typical Application Ranges & Recommendations — Back-up rings for PTFE fluid power seals**

Material Code	Material Description	Pressure Rating *	Temperature Range	Recommended Use
A	Nylon, Molybdenum Di-Sulfide Filled	7,500 psi (517 bar)	-40°F to 250°F (-40°C to 121°C)	<ul style="list-style-type: none"> <li>Petroleum oils and fluids</li> <li>Diesel fuel and fuel oils</li> <li>Phosphate ester fluids</li> <li>Silicone oil and grease</li> <li>Mineral oil and grease</li> </ul>
B	Nylon Glass Filled	7,500 psi (517 bar)	-40°F to 275°F (-40°C to 135°C)	<ul style="list-style-type: none"> <li>Reduced water absorption</li> <li>Improved thermal stability</li> </ul>
C	Acetal	6,000 psi (414 bar)	-40°F to 250°F (-40°C to 121°C)	<ul style="list-style-type: none"> <li>HFA, HFB and HFC fluids</li> <li>Water</li> <li>Petroleum oils and fluids</li> <li>Diesel fuel and fuel oils</li> <li>Mineral oil and grease</li> </ul>
D	PTFE PPS Filled	5000 psi (345 bar)	-100°F to 450°F (-73°C to 232°C)	<ul style="list-style-type: none"> <li>Extended temperature, pressure and media resistance</li> </ul>
E	PEEK Virgin	10,000 psi (690 bar)	-40°F to 450°F (-40°C to 232°C)	<ul style="list-style-type: none"> <li>Extended temperature, pressure and media resistance</li> </ul>

\* Pressure ratings are a general guide only. Pressure ratings are reduced if wear rings are used.

**Table 3-7. Standard (■) vs. Optional (□) materials for PTFE fluid power seal profiles**

PTFE Material Code	PTFE Fluid Power Seal Profile													
	S5	R5	CT	CQ	OE	CP	OA	OD	ON	CR	OC	AD	OQ	OR
0100						□				□		□		
0102						□	■	□		□	■			
0120	□	□			□	□		□	□	□			□	□
0203	■	■		□	□				□					
0204			□				□				□		□	□
0205													■	■
0301					□				□				□	□
0307			□		□			□	□				□	□
0401	□	□	■	■	■	■		■	■	■	□	■		
0502												□	□	□
0601					□				□					

09/01/07



## Chemical Compatibility

It is essential to select seal compounds that are compatible with the environment in which they are used. Even if the proper seal material is chosen based on system temperature and pressure, exposure to certain fluids can drastically reduce seal performance by altering a compound's typical physical properties.

Parker has tested thousands of fluids and is continuously testing many new, popular chemicals to ensure seal material compatibility. Appendix D shows the results of many common seal materials in popular test fluids. This information compares the changes in physical properties of each seal material after it has been soaked in a specific fluid for a given temperature and time. For additional compatibility reports not shown, please contact your local Parker representative.

## Temperature Limits

When selecting a seal material, temperature is a key factor. Heat affects the seal material in several ways:

- Softens the material which accelerates wear
- Accelerates any chemical reaction between the fluid and the seal
- Damages the bond structure of the material
- Increases compression set
- Higher temperatures for extended periods of time may harden thermoset (rubber) materials

Lower end temperature may be as important as the upper end temperature. This is especially true in mobile hydraulics. As the temperature lowers, the following takes place:

- The seal hardens and is less responsive.
- The coefficient of thermal expansion and contraction is approximately ten times that of metals. Therefore the seal lips could start to pull away from the surface of the bore. This loss of lip compression against the colder sealing surfaces can be offset by seal design and proper material selection.
- The opposite is also true. As a bearing or wear ring heats up, binding can occur if there is not a gap designed into the wear ring.

## Storage and Handling

In 1998, the Society of Automotive Engineers (SAE) issued an Aerospace Recommended Practice (ARP) for the storage of elastomer seals and seal assemblies prior to installation. ARP 5316 has been considered

by many as the industry standard; however, Parker has taken a conservative approach to ensure to our customers the highest quality. Both the ARP 5316 and Parker standards for shelf life are shown below in Table 3-8.

**Table 3-8. Recommended storage standards**

Chemical Name	Polymer	ARP 5316	Parker
Aflas®	FEPM	Unlimited	7 Years
Ethylene Propylene	EP, EPR, EPDM	Unlimited	7 Years
Fluorocarbon	FKM	Unlimited	7 Years
Nitrile	NBR, HNBR, XNBR	15 Years	7 Years
Polyurethane	AU or EU	-	10 Years
PolyMyte	TPCE	-	10 Years
Polytetra-fluoroethylene	PTFE	-	Unlimited

The values above assume that proper guidelines for storage conditions are followed. If plastic and rubber products are stored improperly, their physical properties may change. Prior to use, all parts should be checked for hardness, surface cracking or peeling. If any of these conditions are observed, the parts should be discarded. Some compounds can exhibit a build-up of powdery film on their surface over time. This natural occurrence is referred to as bloom and does not in any way negatively impact the function of the seal. Guidelines for proper seal storage are shown in Table 3-9, page 3-21.

Table 3-9. Seal storage &amp; handling guidelines

Seal Storage & Handling Guidelines	
Records	Records should be kept to ensure that stock is rotated such that the first seals in are the first out (FIFO).
Temperature	Seals must be stored away from heat sources such as direct sunlight and heating appliances. Maximum storage temperature is 100°F (38°C). Low temperatures do not typically cause permanent damage to seals, but can result in brittleness, making them susceptible to damage if not handled carefully. Ideally, seals should not be stored at temperatures less than 50°F (10°C) and should be warmed to room temperature before installation.
Ultra Violet	Seal must be protected from direct sunlight and any artificial light that generates ultra violet radiation.
Humidity	Care should be taken to ensure seals are always stored in an environment with a relative humidity of less than 65%. Polyurethane seals in particular are very susceptible to damage from exposure to moisture and should be stored in air-tight containers.
Oxygen and Ozone	Ozone-generating equipment and oxygen exposure can be detrimental to seal compounds. Seals should be stored in air-tight containers. Any electrical equipment that generates a spark should not be used near seal storage.
Contamination	Keeping seals free from contamination will assist promote service life. Good housekeeping practices should be maintained.
Distortion	Large seals should be stored flat when possible and not suspended, which may cause distortion over time. Do not store seals on hooks, nails or pegboard.



## Contents

- Fluid Power Applications ..... 4-1
- Single Acting Hyd. Ram ..... 4-2
- Single Acting Pneu. Cyl. .... 4-3
- Double Acting Cylinder ..... 4-3
- Telescoping Cylinder ..... 4-4
- Cushioned Double Acting Cyl..... 4-5
- Dual-Fluid Power Cylinder ..... 4-5
- Ram Pressure Intensifier ..... 4-6
- Double Acting Intensifier..... 4-7
- Piston-Type Accumulator..... 4-7
- Energy Absorbing Cylinder..... 4-8
- High Shock Cylinder ..... 4-8
- Linear-to-Rotary Converter..... 4-9
- Cartridge Valve ..... 4-10
- Spool Valve ..... 4-11
- Piston Pump ..... 4-11
- Diaphragm Pump..... 4-11

## Fluid Power Applications

When selecting a sealing system for a fluid power application it can be helpful to review sealing components used in similar products. While there are numerous designs of fluid power devices, many share similar characteristics based upon their dynamic motion and function. The following section provides a general overview of common fluid power products along with a description of the sealing systems that are typically used. Despite their considerable variety, reciprocating and oscillating fluid power products fall into relatively few categories. These include:

<b>Power Cylinders</b>	Single-Acting Hydraulic (RAM) Single-Acting Pneumatic Double-Acting Telescoping Cushioned Dual Fluid
<b>Pumping Cylinders</b>	Pressure Intensifier Single Acting Double-Acting
<b>Accumulators</b>	Piston Type
<b>Specialty Cylinders</b>	Energy Absorbing Linear / Rotary Converter
<b>Valves</b>	Cartridge Spool
<b>Pumps</b>	Piston Diaphragm

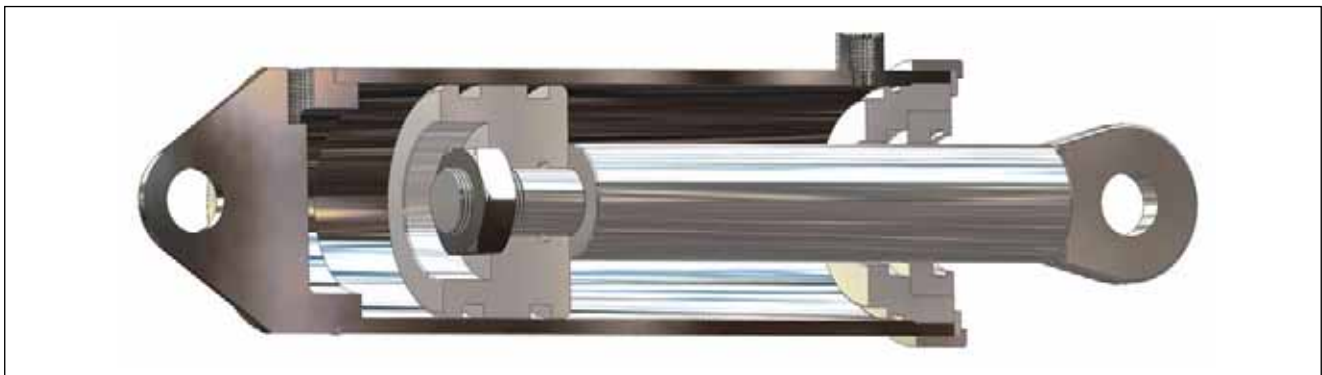

Figure 4-1. Typical Hydraulic Cylinder



## Applications

### Single Acting Hydraulic Ram Concept

Hydraulic rams are single-acting power cylinders that do not utilize a conventional piston. Instead, fluid pressure is applied to the end of the rod (ram) to create force for extension and either gravity or an external force is applied for retraction. The principal appeal of this design is its low manufacturing cost for large sized rams. Lower manufacturing costs are attributed to the fact that the cylinder bore does not require a close tolerance or a smooth surface finish. Only the ram itself needs to be ground and polished. Clearances are only important between the ram O.D. and gland I.D.

Rams that are retracted by gravity alone, customarily use low-friction lip-type seals, such as u-cups or squeeze seals made from PTFE. Low-pressure sealing problems, characteristic of lip-type seals, are seldom significant as the throttled exhaust creates back pressure to energize the seal. Hydraulic rams installed in an upward vertical orientation collect contamination around the rod seal housing.

To prevent contamination from entering the cylinder, snap-in wipers are recommended. Wear rings or bearings are frequently required to prevent contact between polished rams and gland housings. Never rely on seals or wipers to provide lateral support.

If the ram is downward-acting, a spring or external retraction cylinder is used to return the ram into the cylinder. Normally, retraction cylinders are single-acting and apply no force to the load. They can, however, be double-acting and add their force to that of the ram. In many applications, the ram is powered hydraulically, while the retraction cylinders are fast-acting pneumatic units.

Externally retracted rams have more latitude in seal selection since the return force can overcome the extra friction of squeeze-type seals. Downward-acting rams typically have low pressure return strokes which may produce leakage if lip type seals are used. Pressures are usually low during the down stroke until the ram contacts the load.

4



Figure 4-2. Single Acting Hydraulic Ram

## Single Acting Pneumatic Cylinder

Single-acting cylinders, as in the case of hydraulic rams, rely on mechanical means to retract or extend the rod. The cylinder shown is a typical pneumatic design, using an internal spring to extend the rod and air pressure to retract. The spring and pressure port arrangement could be reversed to provide power extension and spring retraction. The piston seal is typically a rubber u-cup profile. To maintain pre-lubricated surfaces a rounded lip profile can be selected for sealing the piston, and the rod if required.

To reduce cost, o-rings are sometimes considered for pneumatic applications. This can be problematic

since o-rings will wipe away pre-lubrication and are prone to instability, spiral failure, high friction, and rapid wear. Selecting u-cup seals will eliminate these problems.

Snap-in wipers are typically used to prevent contamination from entering the cylinder. These can be either polyurethane or rubber depending on the environment. Bearings for these types of cylinders typically do not see heavy side loads. Filled PTFE wear rings or strips are an excellent choice to ensure low friction performance.

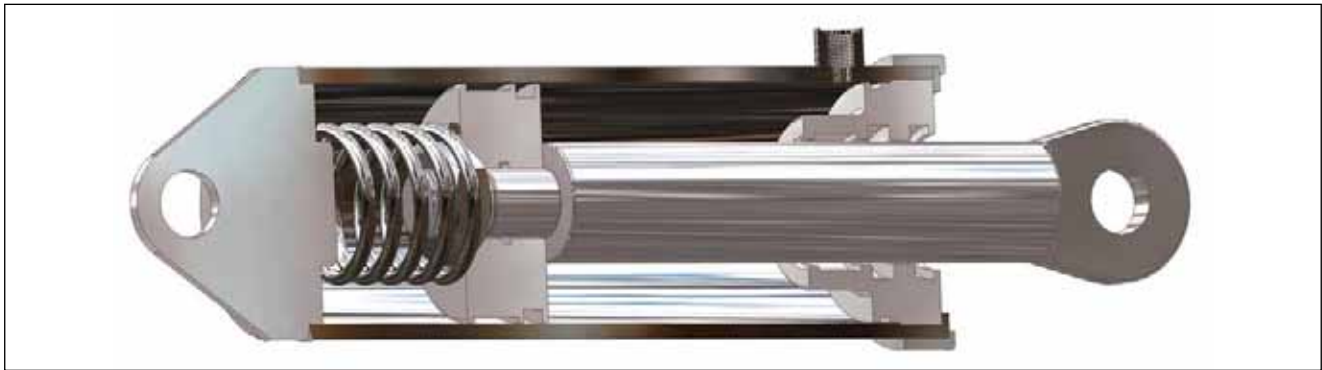

Figure 4-3. Single Acting Pneumatic Cylinder

## Double Acting Power Cylinder

In double acting cylinders fluid pressure is applied to either side of a piston to extend or retract the rod. This is typical of many fluid power cylinders used for hydraulic or pneumatic service at low to high pressures. As shown in Figure 4-4, seals are required for both the piston and rod glands. Clevis mountings at each end of the cylinder permit alignment with external linkages without bending the rod.

There are many options available to seal double-acting cylinders. Dual grooves shown in the piston are designed for a pair of uni-directional (single-acting) seals installed “back-to-back” such that their sealing

lips face away from one another. This orientation allows any fluid that passes by the pressurized seal to easily leak past the unpressurized seal, thus preventing pressure trapping. Never install seals back-to-back with their sealing lips facing one another. This orientation will leak fluid into the space between the seals and pressure trapping will occur. Do not install dual seals in the same groove. The unpressurized seal will not support the pressurized seal resulting in instability and extrusion damage.

The other option to seal the piston is to install a bi-directional seal into a single groove. A single

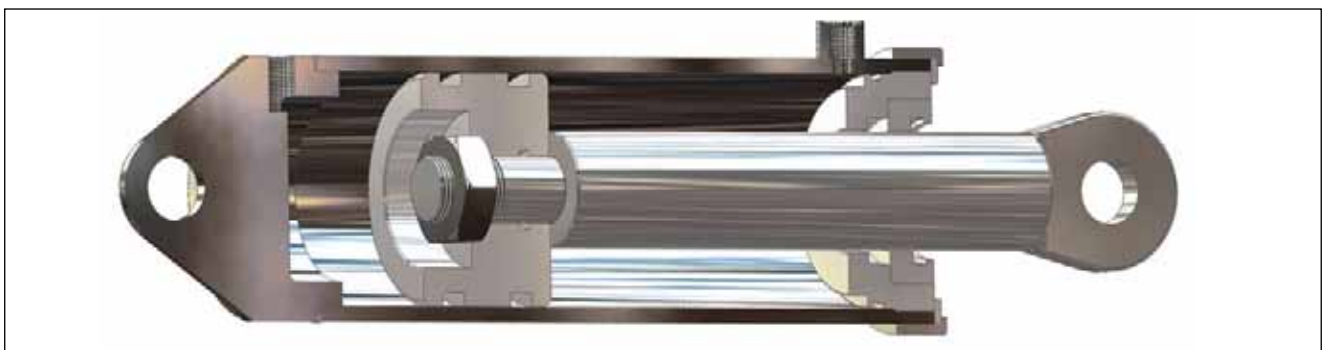

Figure 4-4. Double Acting Power Cylinder

09/01/07

## Applications

bi-directional seal eliminates installation confusion and the possibility of pressure trapping. Selecting a bi-directional seal allows more room on the piston for a wear ring to protect against piston and bore contact. Typically, the wear ring is located on the end cap side of the piston to maximize distance between piston and rod bearing surfaces.

In low to medium-pressure cylinders anti-extrusion back-up rings are not normally required. High pressure may cause the cylinder to expand (breath) allowing the seals to extrude into the clearance gap between the piston and the bore. This may also occur at lower pressures in thin-wall, lightweight cylinders. To protect the seals, back up rings are recommended.

Rod seals may be either uni- or bi-directional, squeeze- or lip-type, depending on the application. As pressure requirements increase, and/or stroke and cycle rates increase, the use of multiple profile sealing systems (buffer and rod seal) are recommended. Rod wipers should be selected to match the application. Moving from snap-in wiper profiles to press fit profiles increases contamination protection. The wiper gland, shown in Figure 4-4, makes it easy to remove and inspect or replace the rod seal. To protect the seals from side loading, the internal side of the rod seal housing can be extended to make room for rod wear rings. Normally such side load forces should be avoided due to their tendency to bend the rod, accelerate wear, and restrict freedom of motion.

### Telescoping Power Cylinder

Telescoping cylinders are usually single-acting cylinders which require an external force, such as gravity or a connected load, for retraction. Through a series of staged extensions this cylinder type provides a long stroke from a much shorter retracted length. They are used extensively to raise hinged beams or booms and dump truck bodies.

When a telescoping cylinder begins to extend, for most designs, the largest-diameter tube will move first at low speed, and the smallest tube will extend last at a higher speed. Control of input flow can regulate extension speed for more uniformity, which may be helpful when acceleration could cause instability in the connected load. It is also characteristic that the cylinder force diminishes as each successive tube reaches the end of its stroke. These force variations must be considered when matching the cylinder to the application.

The telescoping design shown in Figure 4-5 utilizes an internal collar to hold the seal and an external collar to hold the wiper. As each stage extends the internal collar bottoms out against the external collar. This prevents overextension of the tubes. Both collars are designed to also act as bearings. Since such cylinders usually control retraction speed by throttling the exhaust fluid, low-pressure leakage may be minimized enough to permit the use of lip-type seals with virtually no loss of fluid.

The design shown utilizes the inside diameter of each tube as a sealing surface and is never exposed directly to outside contamination. A piston-type profile is required to seal against the tube I.D. Wiper rings become extremely important in telescoping cylinders because so much surface area is exposed to contamination. If the wipers are properly maintained, external contamination will be kept away from the sealing surfaces indefinitely.

Figure 4-5 shows collars made of bearing metals which would be compatible with the tubing metal. Grooves to hold wear rings can also be designed into the collars. In rod type telescoping cylinders where O.D. sealing is employed, it is simpler to maintain lubrication of these bearing surfaces since both seal and wiper ring would be located in the outboard collar, and the bearings could be immersed permanently in the fluid.



Figure 4-5. Telescoping Power Cylinder

## Cushioned Double Acting Cylinder

Cushioned cylinders provide a means of decelerating the piston during the last part of its stroke. This prevents hard impacts which could be destructive to the cylinder and the connected load. While this feature may be provided in many ways, a common design uses a deceleration cavity through which the fluid exhausts during retraction and extension. To reduce fluid flow a rod extension (end cap side of piston) and enlarged rod (spud) are added to obstruct the exhaust cavity at each end of the stroke. In the design shown, the remaining exhaust is forced through a metering valve which can be adjusted for the desired deceleration. When flow is reversed, check valves in each end of the cylinder by-pass the obstructed flow, permitting rapid acceleration. This is further improved when the rod extension or spud clears the port.

To further control the cushioning effect, uniquely designed cushion seals can be incorporated to prevent flow between the rod extension or spud and the deceleration cavity. These cushion seals are highly effective in pneumatic cylinders but are not recommended in most hydraulic cylinders due to extrusion and spiral failure. Pneumatic cushion seals are uni-directional, designed with a series of slots and pedestals to allow gas to easily flow back into the cylinder. Cushion seals eliminate the need for check valves in pneumatic cylinders.

As for other areas of the cylinder that require dynamic seals, they would be selected based on the application parameters. Seals, wipers and wear rings for the piston and rod follow the guidelines described for dual acting cylinders.

## Dual-Fluid Power Cylinder

In some applications it is desirable to utilize one fluid (such as compressed air) to drive a cylinder, along with a second fluid (hydraulic fluid) to regulate the cylinder speed. Being virtually incompressible, hydraulic fluid makes a better regulating fluid than compressible gas. The basic design in Figure 4-7 shows a cylinder in which the rod end is pneumatically driven, and the blind end is hydraulically restrained and regulated. A metering or throttling valve may be adjusted to control the retraction speed. If the hydraulic fluid is transferred into a low-volume accumulator with a captive volume of pressurizing gas, travel will slow down as the reservoir fills and back-pressure builds. If the accumulator is large in relation to the cylinder volume, stroke speed can be held nearly constant for the full travel.

The bi-directional throttling valve shown provides a slow return stroke as well as a regulated power stroke. If fast return is desired, a check valve provision such as that in Figure 4-6 (cushioned cylinder) would by-pass the throttling valve. Another frequent strategy is to use un-metered heads on the cylinder, and provide speed control by means of an external needle valve. If fast return is desired, an external check valve connected to by-pass the throttle can be utilized.

While some lubrication assistance is provided by the hydraulic fluid, it is not prudent to rely on it for the total lubrication of the pneumatic end of the cylinder. If long seal life is required, internally lubricated compounds are recommended.

To create a gas spring or dampening effect, it is possible to reverse the ends of the cylinder to apply

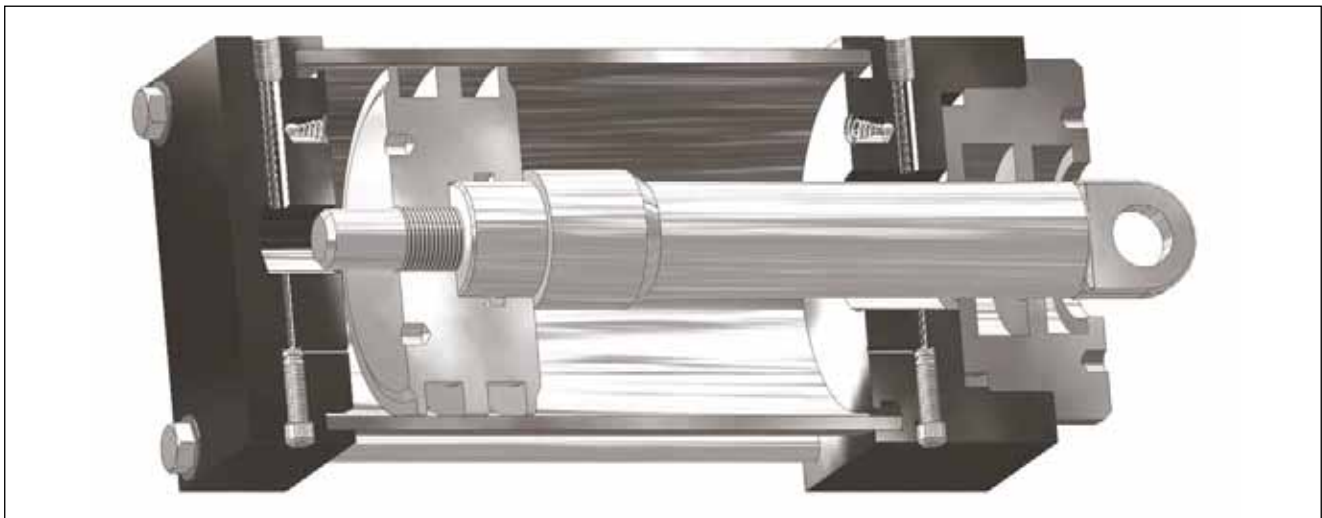

*Figure 4-6. Cushioned Double Acting Cylinder*



## Applications

4

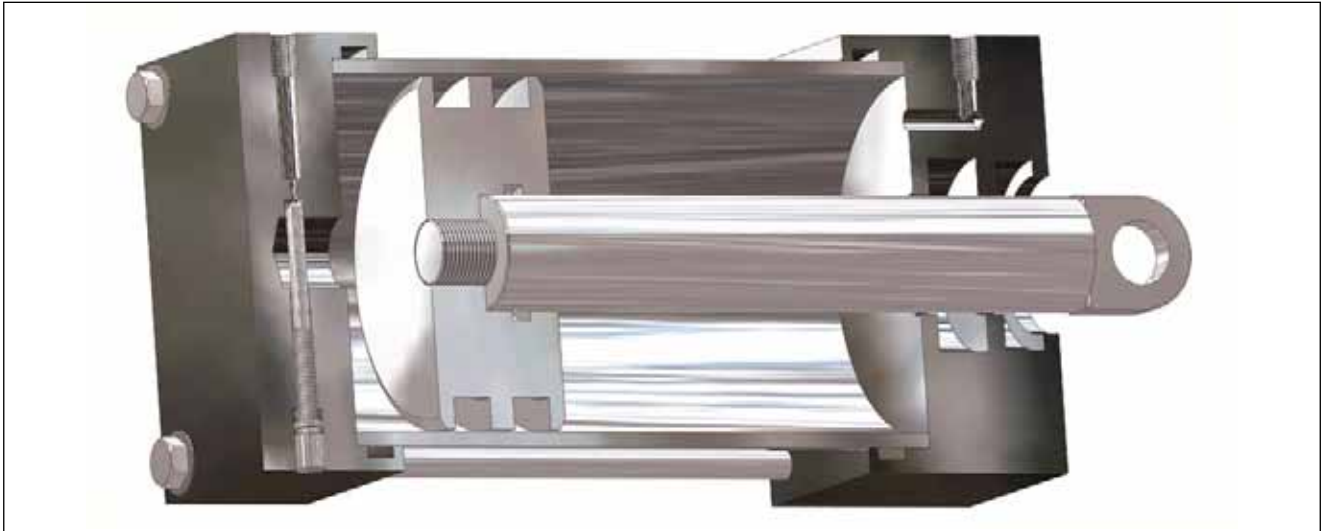

Figure 4-7. Dual-Fluid Power Cylinder

pneumatic pressure to the blind end, achieving a larger net area and consequently higher force while making it a “push” cylinder. With hydraulic fluid at the rod end, the rod seals are constantly lubricated. Also, since the hydraulic fluid is continuously under pressure, it is possible to use lip-type seals with negligible low-pressure sealing problems.

### Ram-Type Pressure Intensifier

Pressure intensifiers utilize the area ratio between the power piston and the ram as a means to multiply output fluid pressure. Inversely, the volume of the output fluid is reduced by the same ratio. Numerous pressure intensifier designs have been mass-produced. The great majority are of the ram type, similar to that in Figure 4-8. They may be powered by the same fluid as that being boosted to a higher

pressure, or by a different fluid. Typical examples include combinations of air, water, steam and oil.

In the design shown, a double-acting power cylinder provides both the pumping and suction stroke to a ram, which is isolated from the primary fluid by multiple seals. Where very high pressures are created, it may be desirable to add an intermediate-pressure fluid, with good lubricating properties, between the primary and secondary fluid seals. This decreases the pressure drop across the seals to help reduce extrusion, wear and leakage.

To ensure extrusion resistance, care should be taken when selecting seals for the intensified fluid. It may be necessary to include an anti-extrusion device to protect the high pressure seal from extrusion.

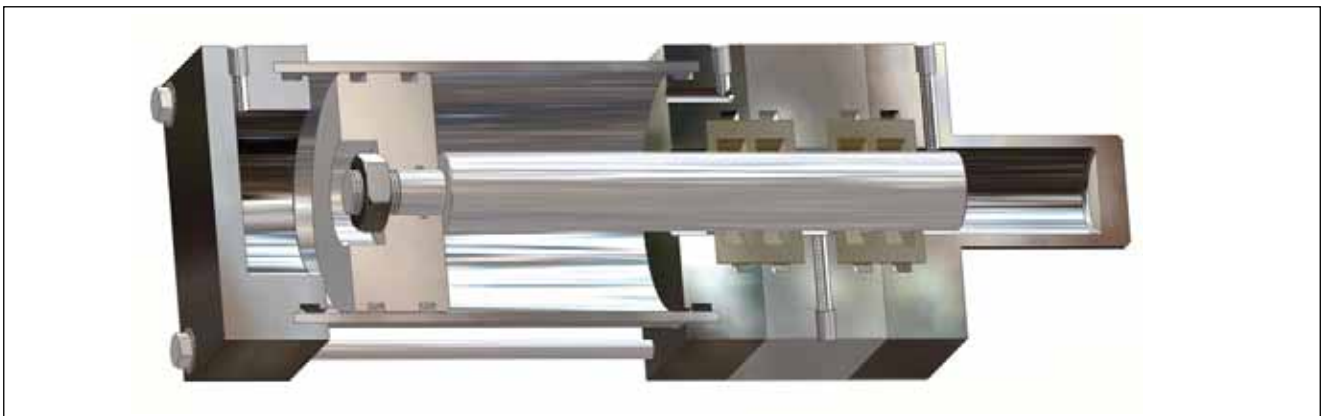

Figure 4-8. Ram-Type Pressure Intensifier



## Double Acting Annulus-Type Pressure Intensifier

A popular design for pressure intensifiers is the annulus-type, which utilizes an enlarged rod diameter to provide differing piston effective areas on opposite piston faces. The net effective area on the rod side equals the full piston area minus the rod area. The ratio of the full piston area to the net area of the rod side establishes the intensification ratio.

A significant difference exists between this design and the ram-type intensifiers previously discussed. The pressure direction across the piston seals is reversed. Note that the lower fluid pressure acts on the larger piston face and the intensified pressure is on the inboard annular face. This means that the seals, if uni-directional, must be oriented with their sealing lips facing inboard. It also means that if the seals are installed in piston grooves, the direction of seal drag will encourage extrusion by adding to the intensified pressure. By installing the piston seals in wall grooves, as shown, friction is subtracted from the pressure forces, thereby minimizing the extrusion tendency. By the same logic, if the seals for the rod are installed in wall grooves, the direction of seal drag along with pressure act together to increase the extrusion tendency.

If the intensification chamber (the annular volume) is recharged by fluid under pressure, the double acting version shown will produce higher intensified pressure. This is achieved by adding the force developed in the annulus. The intensified output pressure would be:

$$\text{Output Pressure} = \frac{A_a + A_p \times P_p}{A_a}$$

If the annulus is recharged by a fluid at a different pressure than that of the power fluid ( $P_p$ ), the intensified output pressure would be:

$$\text{Output Pressure} = \frac{(A_a P_p + A_p P_p)}{A_a}$$

In these equations:

$A_a$  = Annulus Area

$A_p$  = Piston Area

$P_a$  = Recharging Pressure

$P_p$  = Power Fluid Supply Pressure

As with the ram-type intensifiers, it is often preferred to mount this type vertically to minimize side loads, thereby reducing the size of the bearings.

When the annulus is recharged under pressure (i.e., not by a suction stroke), the piston seals may be lip style with their bases outboard and their sealing face toward the annular volumes. This is possible because pressure in the annulus will always exceed that in the piston area. For the grooved rod, a bi-directional seal may be the better choice, since the pressure directions alternate and considerably more space would be required for a pair of uni-directional seals in separate grooves.

## Piston-Type Accumulator

In a fluid power system, piston-type accumulators are used to store pressurized fluid for use when additional fluid volume is required. As shown in Figure 4-9, a wide floating piston separates a compressible gas from a liquid. In this example, pressurized gas is located on the cavity side of the piston. A floating piston also allows for pressure fluctuation in the system.

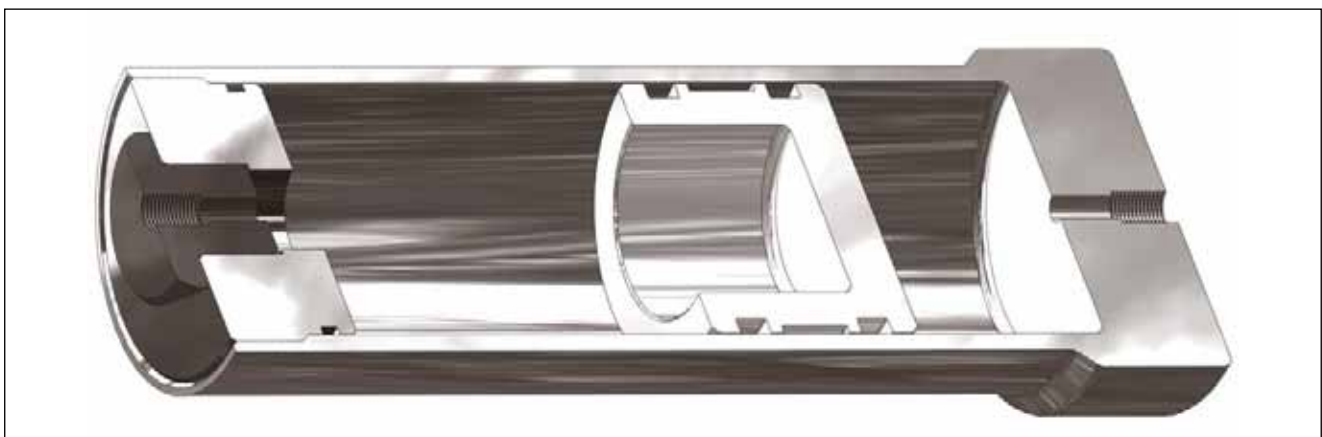

Figure 4-9. Double Acting Piston-Type Accumulator

## Applications

Piston-type accumulators are unique in that there is very little pressure drop across their seals, even though the system pressure may be very high. Actually, the principal source of pressure drop across the seal is the friction between the seal and the cylinder (plus bearing friction, where used) until the piston reaches the end of its travel. Designing the system so that there is insufficient fluid to top out the piston is a simple method of preventing high pressures across the seals.

Low friction is not necessarily a design objective in selecting a seal. Squeeze seals, which offer improved low pressure sealing, are desired so long as they provide smooth travel with low wear. If a bi-directional seal is used, additional space is made available for a wider wear ring. The wear ring should be located on the lubricated side of the piston. To help prevent contamination that can damage the seals or increase wear, accumulators should be mounted in the vertical position.

### Energy Absorbing Cylinder

Concentric double walls provide both the transfer channel and space for gas “spring” to accommodate the differential volumes in opposite ends of this energy absorbing design. When a moving mass engages the large rod, it drives the piston against the coil spring. Displaced hydraulic fluid passes through the fixed orifices, through the annular channel, and into the volume on the opposite side of the piston. As the piston covers the orifice ports, flow becomes progressively restricted near the end of the stroke. When the last port is covered, the only exit from the pressurized end is through the small clearance gap between the piston and the cylinder, which provides effective final dampening action. Since the

rod diameters in the opposite ends of the cylinder are different, the change in volume on the opposite sides of the piston is not directly proportional (that is, more fluid is displaced than there is room for on the receiving side). This difference is absorbed by the volume of gas trapped in the top of the annular space.

Some versions of this design utilize a piston seal facing the spring-end of the cylinder, but the shock loading on impact can twist the seal in its groove and set up a high-probability extrusion situation. Where severe impacts are anticipated, choose seals for their high stability and ensure the seal does not travel over the orifice ports.

The return stroke is usually provided by the compressed spring alone. In this design, the return stroke will be slow since the flow must pass through the same fixed orifices in the reverse direction with only the spring energy to drive it. In other designs, the load may also power the return stroke.

### High Shock Energy Absorbing Cylinder

Where it is possible to use an external hydraulic accumulator or connect into a hydraulic system with its own accumulator, a ram-type, energy absorbing cylinder may be safer and easier to regulate than the previous design (shown in Figure 4-10). This design utilizes a snug-fitting ram to isolate the rod seal from shock pressures developed on the ram face. Note that any leakage past the snug-fitting ram will bleed off through the oil return passage with fluid from the orifice plugs. As shown in Figure 4-11, only a single rod seal is required. A wide variety of rod seals could be used in this application with the principal deciding factors being the pressure range of the connected hydraulic accumulator, and the friction at the rod and seal interface.

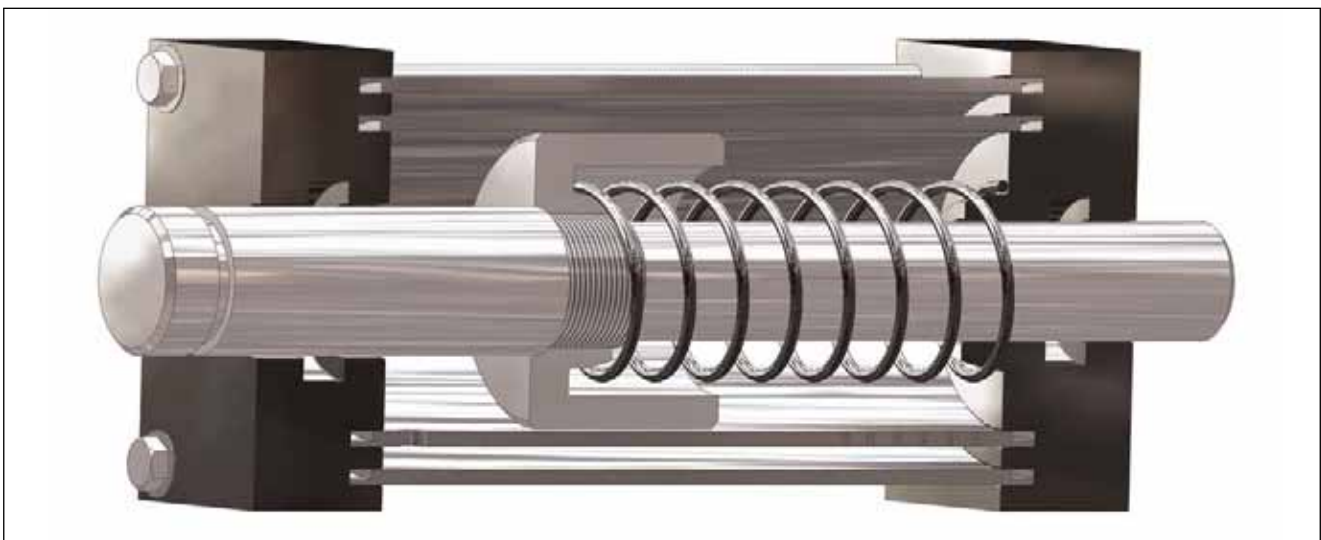

Figure 4-10. Energy Absorbing Cylinder

09/01/07

To avoid excessively slow return after compression, a check valve in the blind head will permit oil to by-pass the orifice plugs under pressure from the accumulator. The rate of energy absorption (and its conversion to heat energy) can be varied by adjusting variable orifice plugs (not shown) or by changing the fixed plugs (shown) to plugs with higher or lower clearances.

### Linear-to-Rotary Motion Converter

A linear-to-rotary motion converter is a rack and pinion type design that utilizes a fluid power linear actuator to drive rotary motion. As shown in Figure 4-12 the rod and piston are fixed, while the cylinder bore and end glands move in reciprocating motion. A toothed rack engages a pinion gear, which rotates as the cylinder strokes.

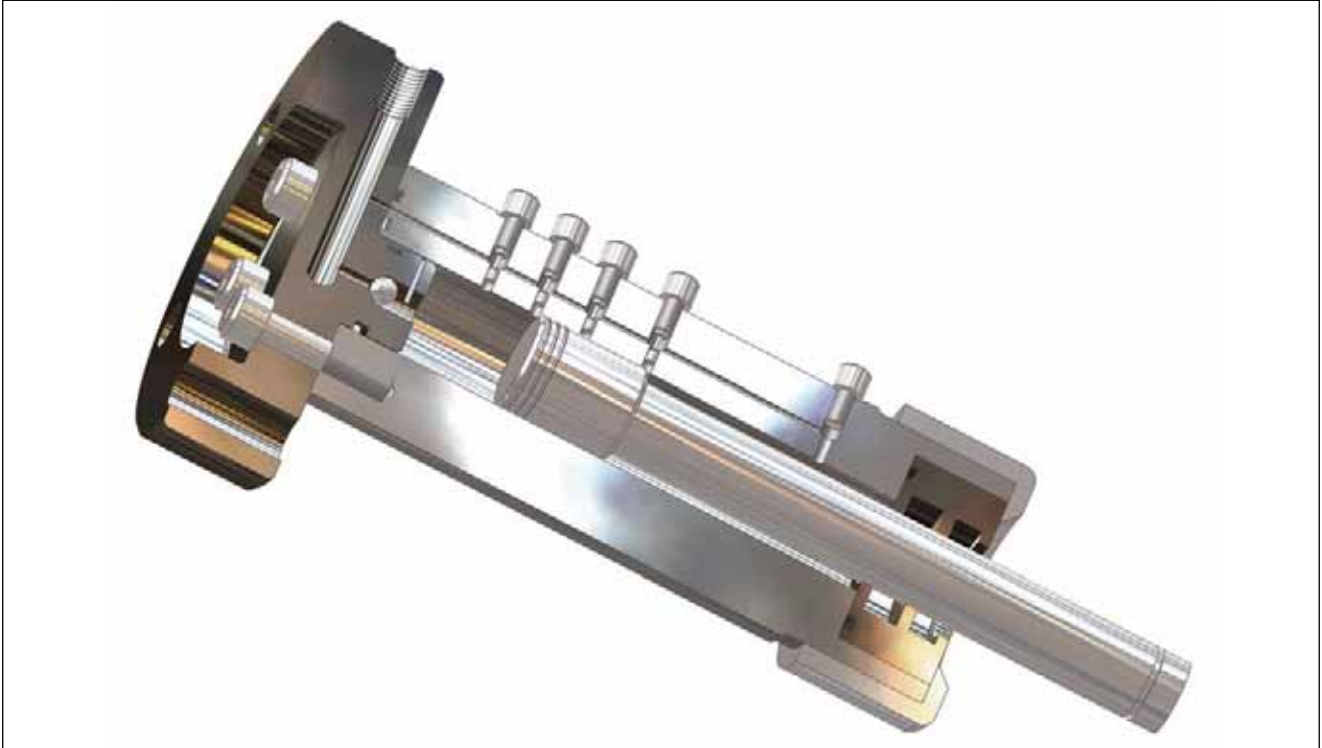

*Figure 4-11. High Shock Energy Absorbing Cylinder*

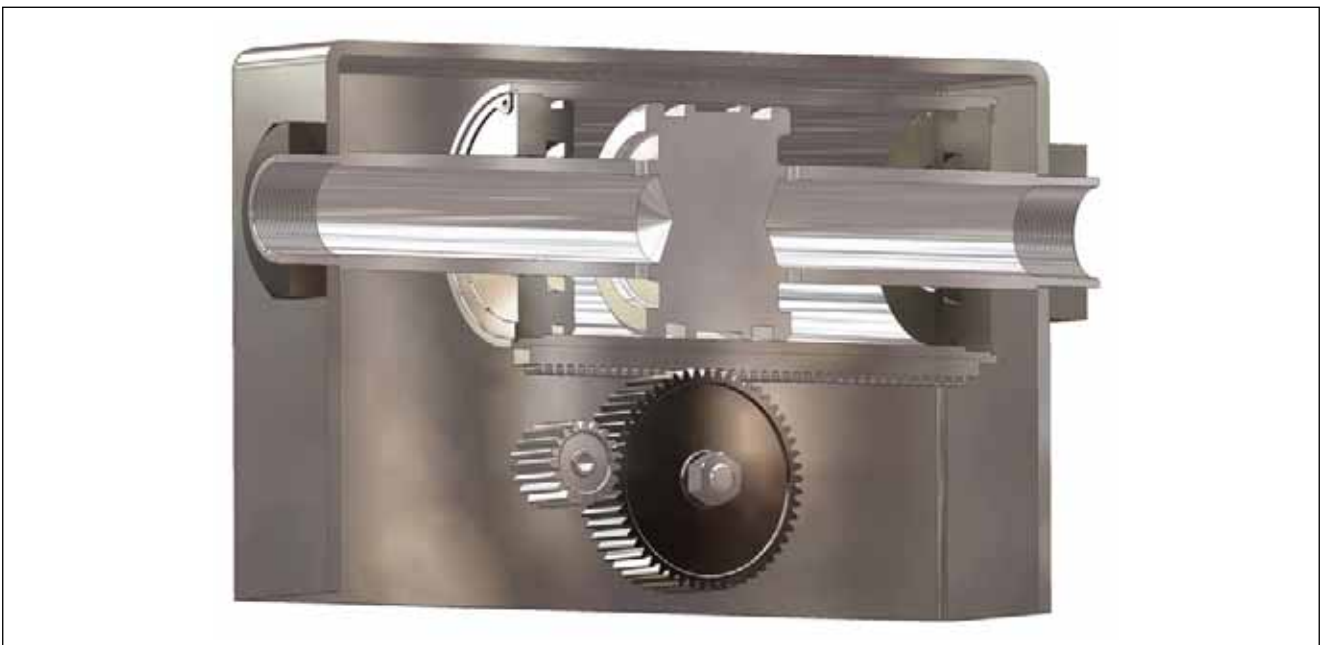

*Figure 4-12. Linear-to-Rotary Motion Converter*

09/01/07

## Applications

Since the rod is fixed, it may be possible to feed the input and exhaust fluid through a hollow portion of the rod as shown. Ports located deep in the rod allow fluid to flow through the cylinder. The fixed double-ends of the cylinder help to maintain a firm, precision engagement between the rack and pinion. Since this engagement generates some lateral force, a piston bearing may be required to maintain concentricity of the piston in the cylinder. Typically, the piston always remains directly above the pinion, so additional rod bearings may not be required. In applications where an off-center load is imparted by the pinion, it may be necessary to add rod bearings to the end caps to resist the torque on the cylinder. Dual lip seals or a single bi-directional seal can be selected for the piston. Both the piston and rod seals should be selected based on the operating parameters of the application. Although the cylinder shown is positioned in an enclosed area, it may be necessary to add rod wipers to provide additional protection from contamination.

## Cartridge Valve

Cartridge valves can be thought of as “bodyless”—valves without an integral housing—because they consist of only the internal moving elements of the valves. After a cartridge is inserted into a cavity, such as a manifold with appropriate flow passageways, the resulting valve performs like any conventional valve. Slip-in cartridges are held in the cavity by a cover plate or can be designed to screw directly into the cavity (see Figure 4-13). Another type of insertable cartridge valve has circumferential grooves. After it is inserted into the cavity, it is held in place by swaging internally with a tapered pin that expands the cartridge diameter into interference contact with the bore.

Historically, an o-ring and a single back up comprise the two piece sealing system used in most cartridge valves. Sealing against a dynamic surface, an o-ring can twist and fail. A single, stable polyurethane profile designed to directly retrofit the traditional groove provides easier installation, improved stability and better extrusion resistance.

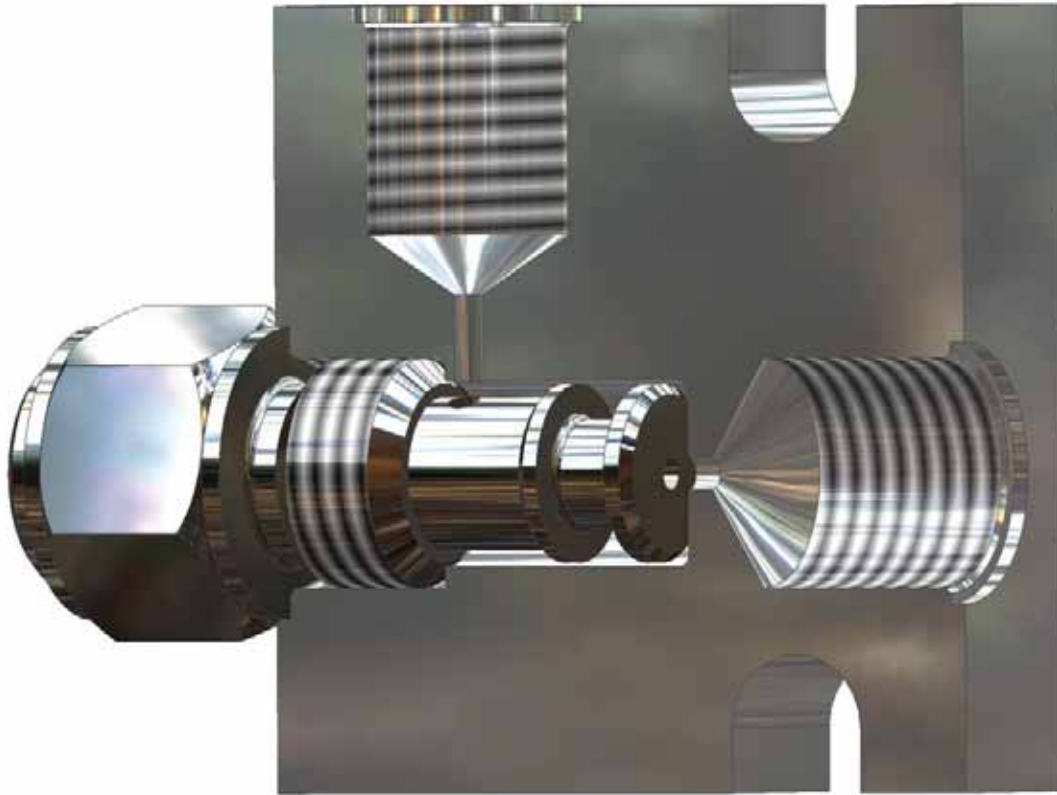

Figure 4-13. Cartridge Valve



## Spool Valve

A spool valve is a directional-control valve in which a spool slides axially in a bore to direct the flow of system fluid. The valve element slides back and forth to block and uncover ports in the housing. Sometimes called a piston type, the sliding-spool valve has a piston of which the inner areas are equal. Pressure from the inlet ports acts equally on both inner piston areas regardless of the position of the spool. Internal sealing is done by a machine fit between the spool and valve body or sleeve. A lip seal and wiper are recommended to seal the external end of the spool.

Spool valves are often classified according to the flow conditions created when it is in the normal or neutral position. A closed-center spool blocks all valve ports from each other when in the normal position. In an open-center spool, all valve ports are open to each other when the spool is in the normal position. Spool valves (see Figure 4-14) are popular on modern hydraulic systems because they:

- Can be precision-ground for fine-oil metering.
- Can be made to handle flows in many directions by adding extra lands and oil ports.
- Stack easily into one compact control package, which is important on mobile systems.

## Piston Pump

Piston pumps and plunger pumps are reciprocating pumps that use a plunger or piston to move media through a cylindrical chamber. The plunger or piston is actuated by a steam powered, pneumatic, hydraulic, or electric drive. Piston pumps and plunger pumps are also called well service pumps, high pressure pumps, or high viscosity pumps.

Seals are an integral part of piston pumps and plunger pumps to separate the power fluid from the media that is being pumped. A stuffing box or packing is used to seal the joint between the vessel where the media is transferred and the plunger or piston. A stuffing box may be composed of bushings, packing or seal rings, and a gland.

The difference between piston pumps and plunger pumps as compared to rotary piston pumps is the actual mechanism used to transfer the fluid. The piston elements moving along an axis are called axial piston pumps. Rotary piston pumps typically have an internal rotating mechanism that moves the piston.

## Diaphragm Pump

Diaphragm pumps are common industrial pumps that use positive displacement to move liquids. These devices typically include a single diaphragm and

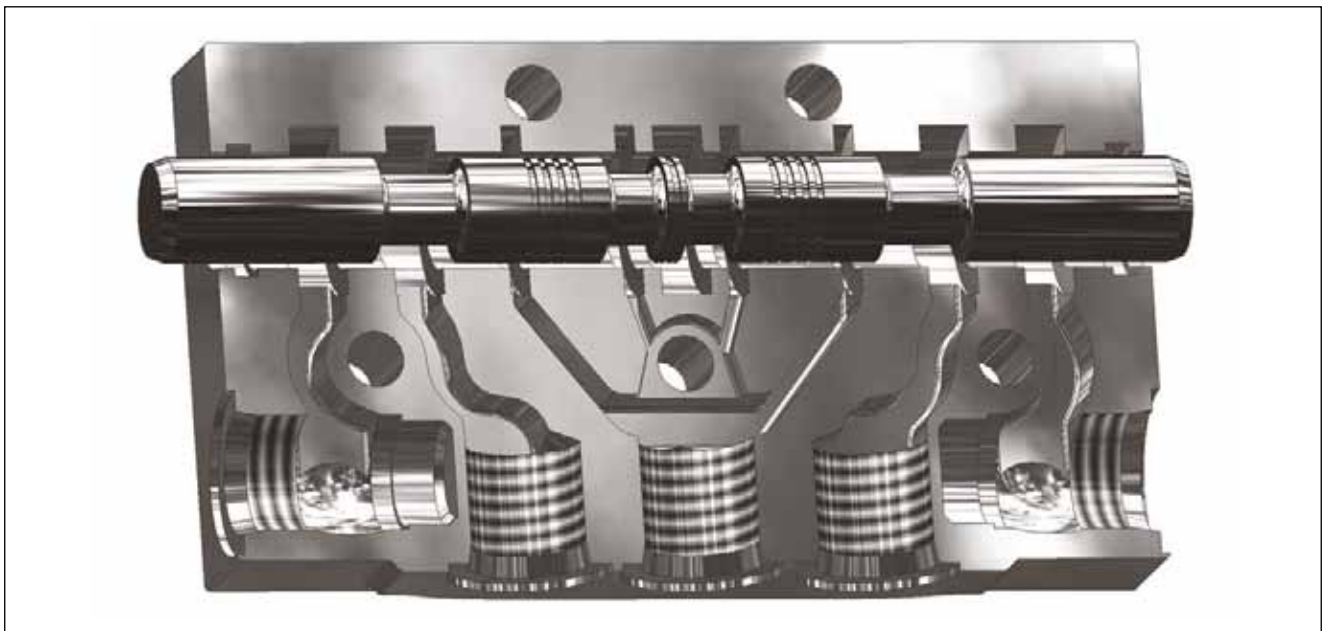

Figure 4-14. Spool Valve



## Applications

chamber, as well as suction and discharge check valves to prevent backflow. Pistons are either coupled to the diaphragm, or used to force hydraulic oil to drive the diaphragm. Diaphragm pumps are highly reliable because they do not include internal parts that rub against each other. In fact, prolonged diaphragm life may be possible if the diaphragm pump is run dry to prime. Typically, wear on the diaphragm or flap is due to the corrosive properties of media fluids or gases

and/or excessive air supply pressures. Diaphragm materials such as ethylene propylene (EPDM), polytetrafluoroethylene (PTFE), plastic, rubber, and elastomers provide resistance to chemicals, sunlight, weathering, and ozone. Housing materials include aluminum, brass or bronze, cast iron, plastic and stainless steel. Rugged diaphragm pump housings can withstand high temperatures and may be exposed to various grades of water, oils, and other solvents.

4

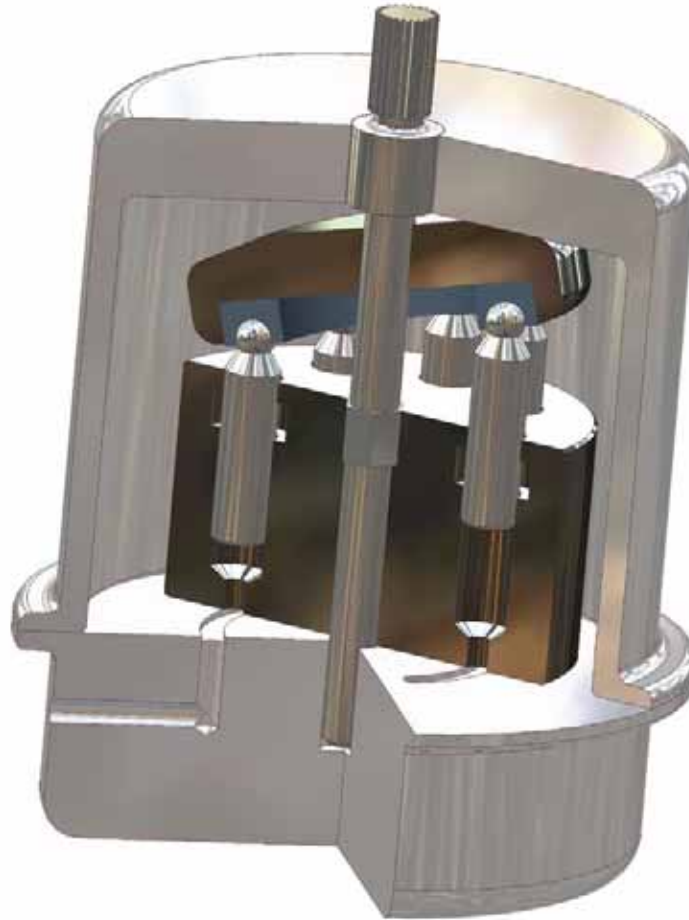

Figure 4-15. Piston Pump

## Contents

Product Offering ..... 5-2  
Decision Tree ..... 5-3  
Rod Seal Profiles  
BD ..... 5-5  
BT ..... 5-7  
BS ..... 5-9  
B3 ..... 5-11  
UR ..... 5-13  
E5 ..... 5-21  
TR ..... 5-24  
ON ..... 5-28  
CR ..... 5-32  
OC ..... 5-39  
BR ..... 5-45  
OD ..... 5-48  
V6 ..... 5-54  
OR ..... 5-57

## Rod Seals

Parker offers a wide range of hydraulic and pneumatic rod seal profiles to meet the broad demands of the fluid power industry. These rod seals are offered in a variety of compounds and lip geometries for the best possible solution for a given application. A majority of Parker rod seals are manufactured utilizing a precision knife trim process to ensure the sealing contact with the dynamic surface yields the best possible performance. When combined with other Parker profiles, including bearings, buffer seals, dirt excluders, and static gland seals, Parker rod seals have proven to provide long life and leak free performance.



# Rod Seal Product Offering

Catalog EPS 5370/USA

## Profiles

Table 5-1: Product Profiles

Series	Description	Application (Duty)				Page	Series	Description	Application (Duty)				Page
		Light	Medium	Heavy	Pneumatic				Light	Medium	Heavy	Pneumatic	
BD	Premium O-ring Energized Lip Seal (available with optional back-up)					5-5	ON						5-28
BT	Premium U-cup Rod Seal with Secondary Stabilizing Lip					5-7	CR						5-32
BS	U-cup Rod Seal with Secondary Stabilizing Lip					5-9	OC						5-39
B3	U-cup Rod Seal					5-11	BR						5-45
UR	Industrial U-cup Rod Seal					5-13	OD						5-48
E5	Premium Rounded Lip U-cup Rod Seal					5-21	V6						5-54
TR	Compact Seal with Anti-Extrusion Technology					5-24	OR						5-57

5

09/01/07



# Rod Seal Decision Tree

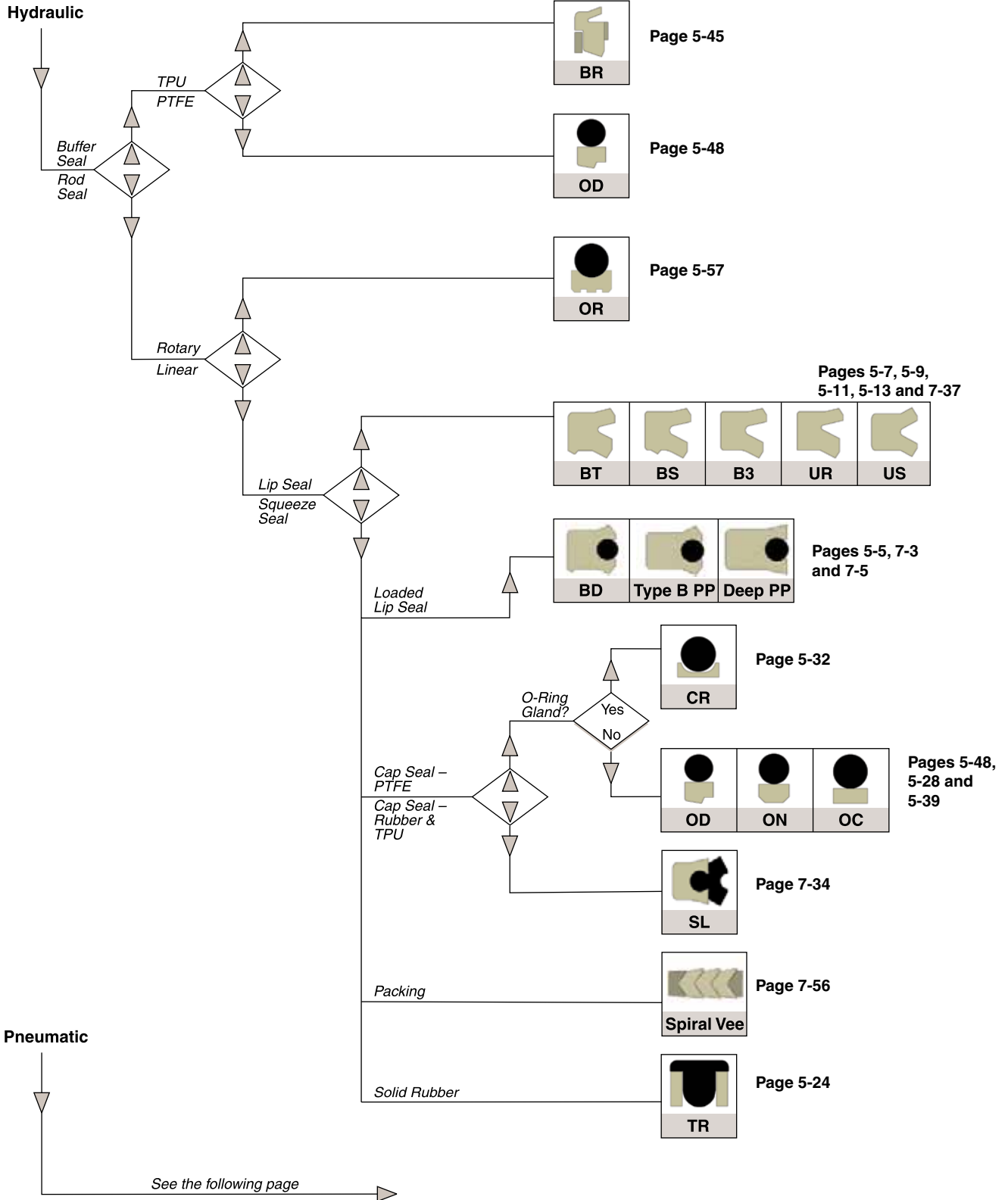

# Rod Seals

## Non-Symmetrical Rod Decision Tree (continued)

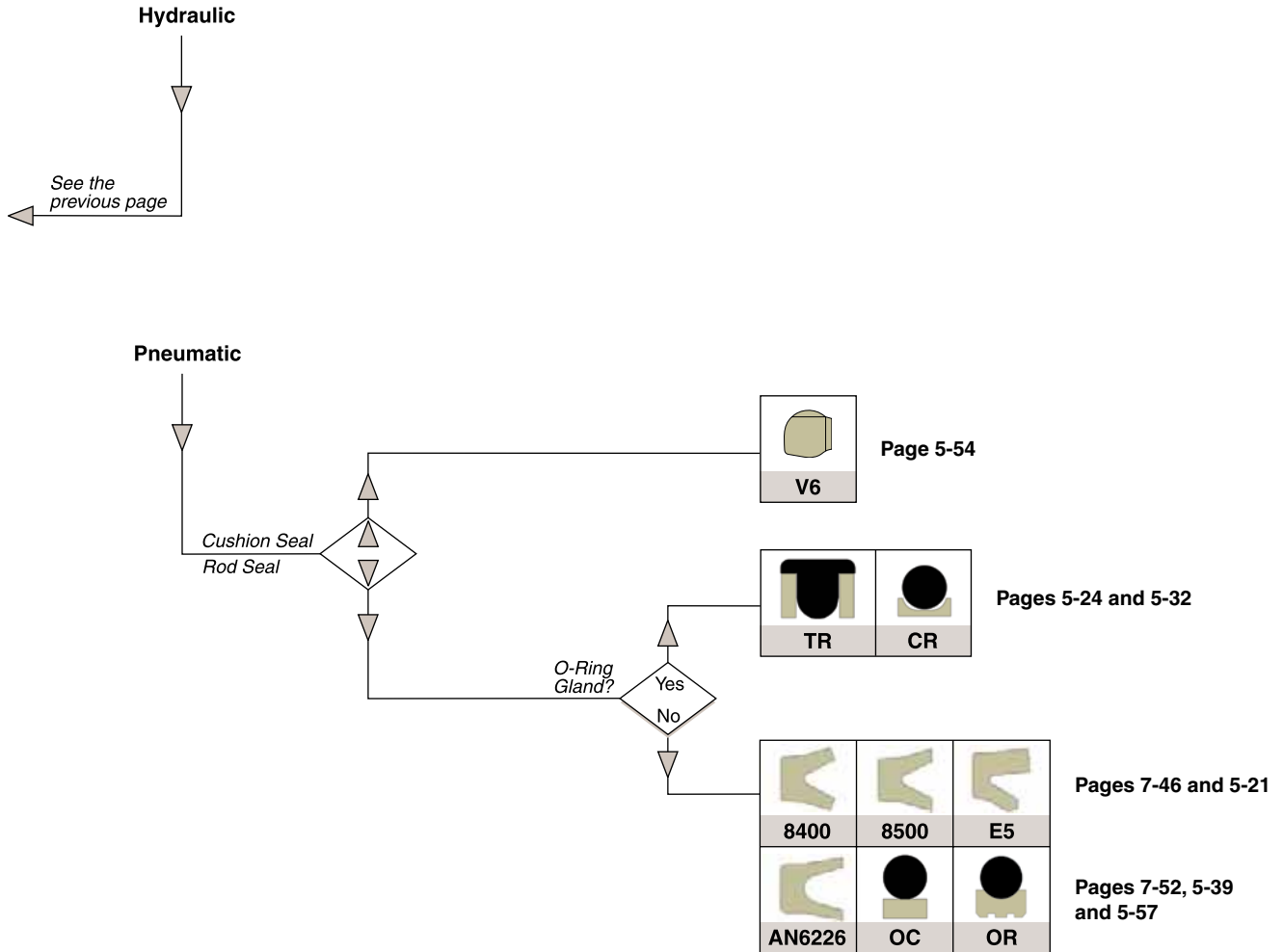

5



# Rod Seal BD Profile

Catalog EPS 5370/USA



## BD Profile, Premium O-ring Energized Lip Seal

The BD profile is a non-symmetrical profile rod seal. Its rectangular shaped cross section ensures stability in the gland. The o-ring energizer functions as a spring to maintain sealing contact under low pressure or vacuum applications. The knife trimmed, beveled lip does an excellent job wiping fluid film. A secondary sealing lip is located below the primary sealing lip, just above the base of the seal, to provide enhanced sealing performance and ensure a tight, stable fit in the gland. Available in Parker's proprietary urethanes, the BD profile provides long life, extrusion resistance, low compression set, shock load resistance and increased sealing performance at zero pressure. The BD profile is designed to be used as a stand alone rod seal or for use with the BR or OD profile buffer seals for more critical sealing applications. Also available with a positively-activated back-up.

5

### Technical Data

Standard Materials*	Temperature Range	Pressure Range†	Surface Speed
P4300A90	-65°F to 275°F (-54°C to 135°C)	5000 psi (344 bar)	< 1.6 ft/s (0.5 m/s)
P4301A90	-65°F to 275°F (-54°C to 135°C)	5000 psi (344 bar)	< 1.6 ft/s (0.5 m/s)
P4700A90	-65°F to 200°F (-54°C to 93°C)	5000 psi (344 bar)	< 1.6 ft/s (0.5 m/s)
P5065A88	-70°F to 200°F (-57°C to 93°C)	3500 psi (241 bar)	< 1.6 ft/s (0.5 m/s)

**\*Alternate Materials:** For applications that may require an alternate material, please contact your local Parker Seal representative.

**†Pressure Range** without wear rings (see Table 2-4, page 2-5).

**Pressure Range** with positively-activated back-up to 10,000 psi (688 bar).

**Options:** A back-up ring located in the heel of the BD profile can be provided for enhanced extrusion protection. See part number nomenclature for designating this option. Contact your local Parker Seal representative for price and availability.



BD Cross-Section

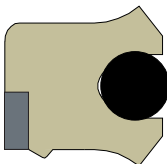

BD Cross-Section  
with Back-up

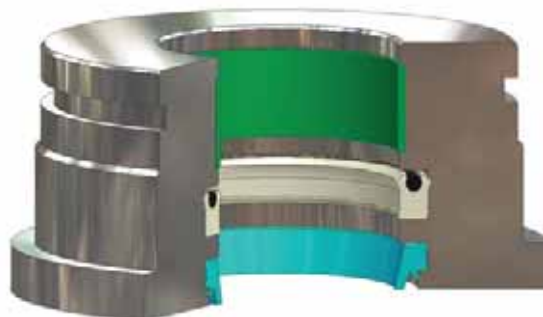

BD Installed in Rod Gland

09/01/07

## BD Profile

### Part Number Nomenclature — BD Profile

Table 5-2. BD Profile — Inch

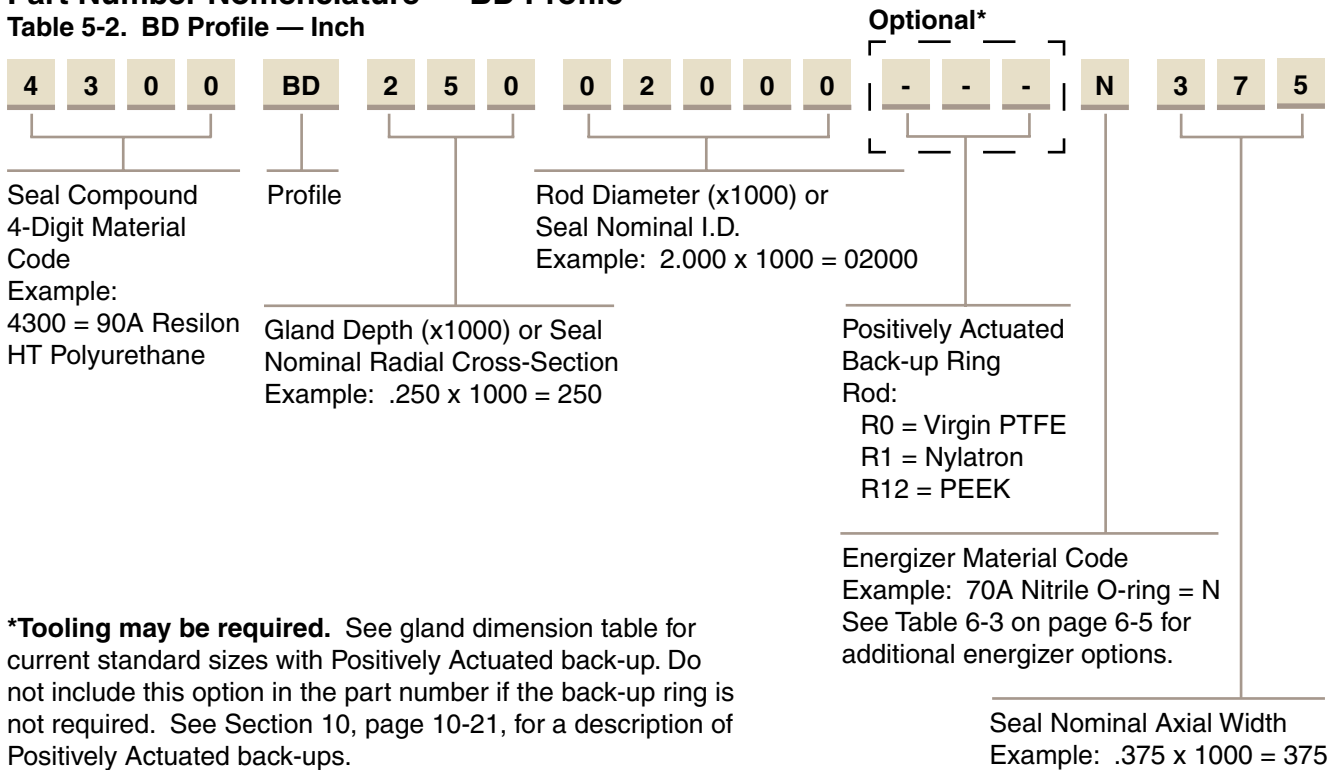

5

**\*Tooling may be required.** See gland dimension table for current standard sizes with Positively Actuated back-up. Do not include this option in the part number if the back-up ring is not required. See Section 10, page 10-21, for a description of Positively Actuated back-ups.

### Part Number Nomenclature — BD Profile

Table 5-3. BD Profile — Metric

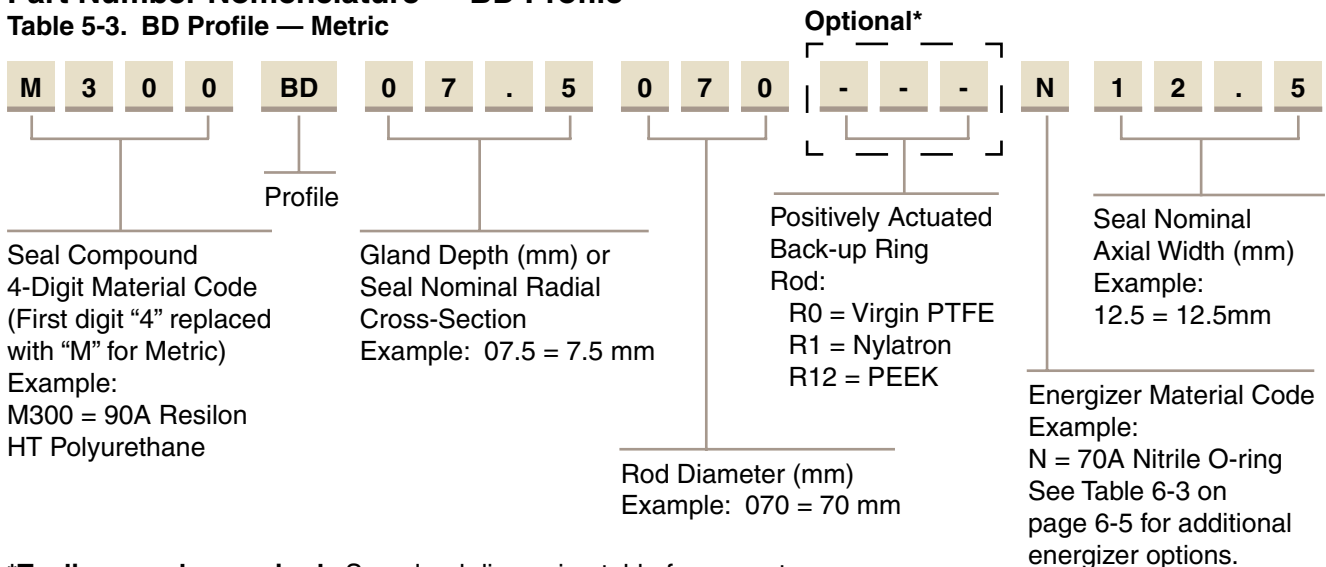

**\*Tooling may be required.** See gland dimension table for current standard sizes with Positively Actuated back-up. Do not include this option in the part number if the back-up ring is not required. See Section 10, page 10-21, for a description of Positively Actuated back-ups.

### Gland Dimensions — BD Profile

BD gland dimensions are provided in Table 5-12 on page 5-15.

09/01/07



# Rod Seal BT Profile

Catalog EPS 5370/USA



## BT Profile, Premium U-cup Rod Seal with Secondary Stabilizing Lip

The BT profile is a non-symmetrical design for use in hydraulic rod sealing applications. Using Finite Element Analysis, the BT profile was designed to provide improved sealing performance and stability in the gland. A knife trimming process is used to form the beveled lip which is best for removing fluid from the rod. By design, the BT profile has a more robust primary sealing lip than the BS profile and the secondary lip is located at the base of the heel. The standard compound for the BT profile is Parker's proprietary Resilon compound. The BT profile provides long life, extrusion resistance, low compression set, shock load resistance and increased sealing performance at zero pressure. The BT profile is designed for use as a stand alone rod seal or for use with the BR or OD profile buffer seals for more critical sealing applications.

5

### Technical Data

Standard Materials*	Temperature Range	Pressure Range†	Surface Speed
P4300A90	-65°F to 275°F (-54°C to 135°C)	5000 psi (344 bar)	< 1.6 ft/s (0.5 m/s)
P4301A90	-65°F to 275°F (-54°C to 135°C)	5000 psi (344 bar)	< 1.6 ft/s (0.5 m/s)

**\*Alternate Materials:** For applications that may require an alternate material, please contact your local Parker Seal representative.

**†Pressure Range** without wear rings (see Table 2-4, page 2-5).



*BT Cross-Section*

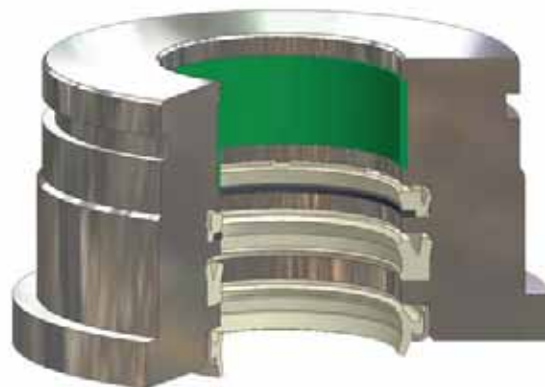

*BT Installed in Rod Gland*

09/01/07

**BT Profile**

**Part Number Nomenclature — BT Profile**

**Table 5-4. BT Profile — Inch**

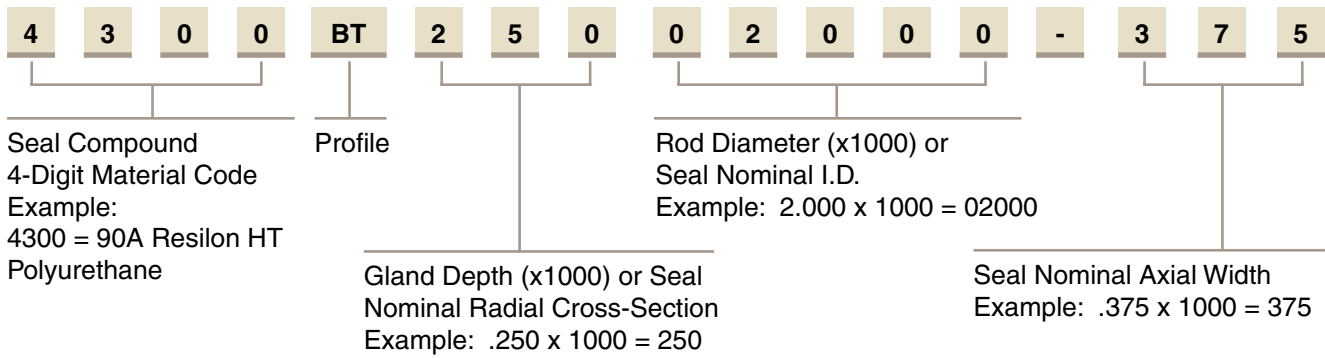

**Part Number Nomenclature — BT Profile**

**Table 5-5. BT Profile — Metric**

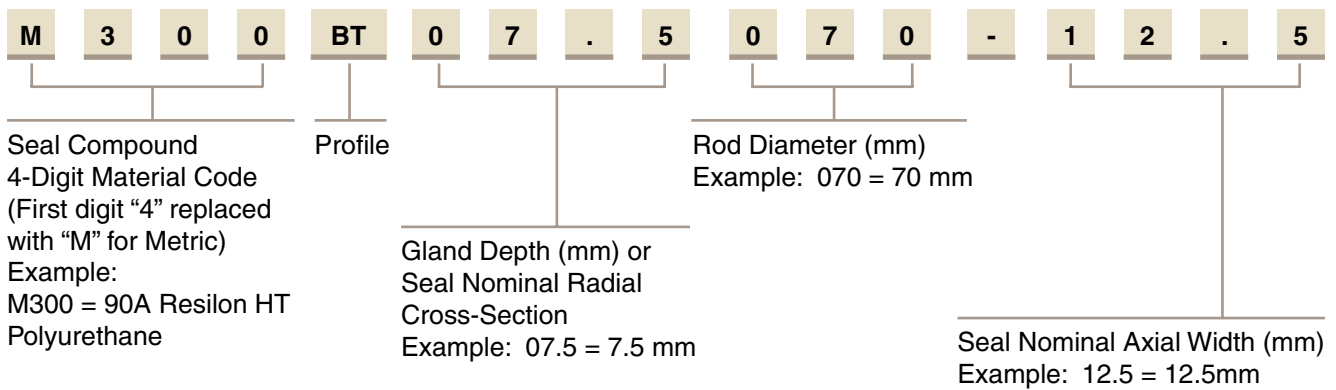

**Gland Dimensions — BT Profile**

BT gland dimensions are provided in Table 5-12 on page 5-15.

# Rod Seal BS Profile

Catalog EPS 5370/USA

## BS Profile, U-cup Rod Seal with Secondary Stabilizing Lip



The BS profile is a non-symmetrical profile designed for use in hydraulic rod sealing applications. A knife trimmed beveled sealing lip does an excellent job wiping fluid from the rod. In addition, a secondary sealing lip is located just above the base of the seal to provide enhanced sealing performance and ensure a tight, stable fit in the gland. Available in Parker proprietary urethanes, the BS profile provides long life, extrusion resistance, low compression set, shock load resistance and increased sealing performance at zero pressure. The BS profile is designed to be used as a stand alone rod seal or for use with the BR or OD profile buffer seals for more critical sealing applications.



*BS Cross-Section*

### Technical Data

Standard Materials*	Temperature Range	Pressure Range†	Surface Speed
P4300A90	-65°F to 275°F (-54°C to 135°C)	5000 psi (344 bar)	< 1.6 ft/s (0.5 m/s)
P4615A90	-65°F to 200°F (-54°C to 93°C)	5000 psi (344 bar)	< 1.6 ft/s (0.5 m/s)
P4700A90	-65°F to 200°F (-54°C to 93°C)	5000 psi (344 bar)	< 1.6 ft/s (0.5 m/s)
P5065A88	-70°F to 200°F (-57°C to 93°C)	3500 psi (241 bar)	< 1.6 ft/s (0.5 m/s)

**\*Alternate Materials:** For applications that may require an alternate material, please contact your local Parker Seal representative.

**†Pressure Range** without wear rings (see Table 2-4, page 2-5).

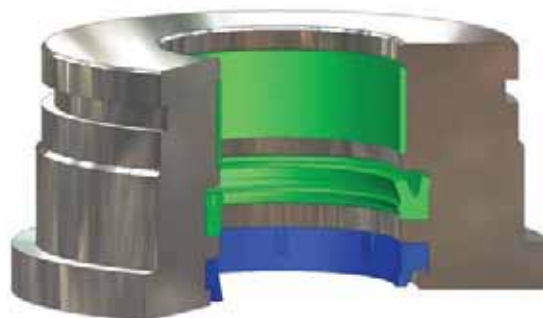

*BS Installed in Rod Gland*

5

09/01/07



## BS Profile

### Part Number Nomenclature — BS Profile

Table 5-6. BS Profile — Inch

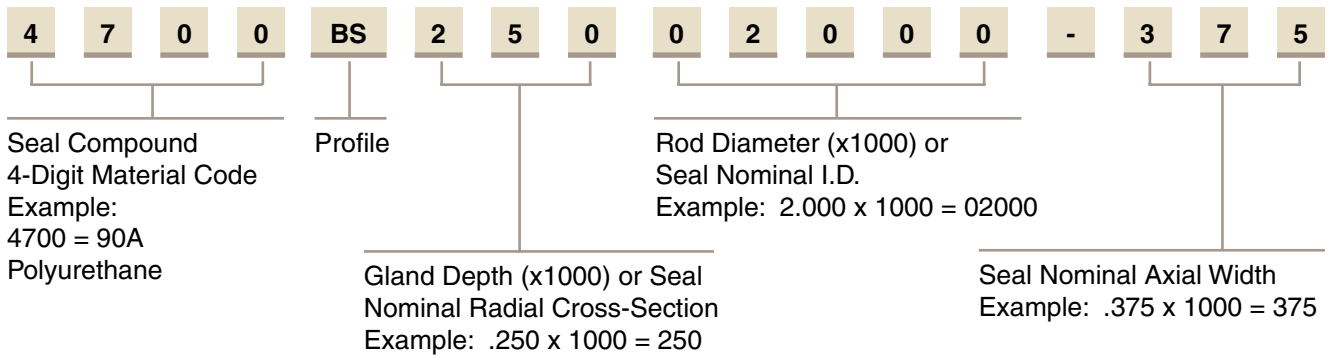

### Part Number Nomenclature — BS Profile

Table 5-7. BS Profile — Metric

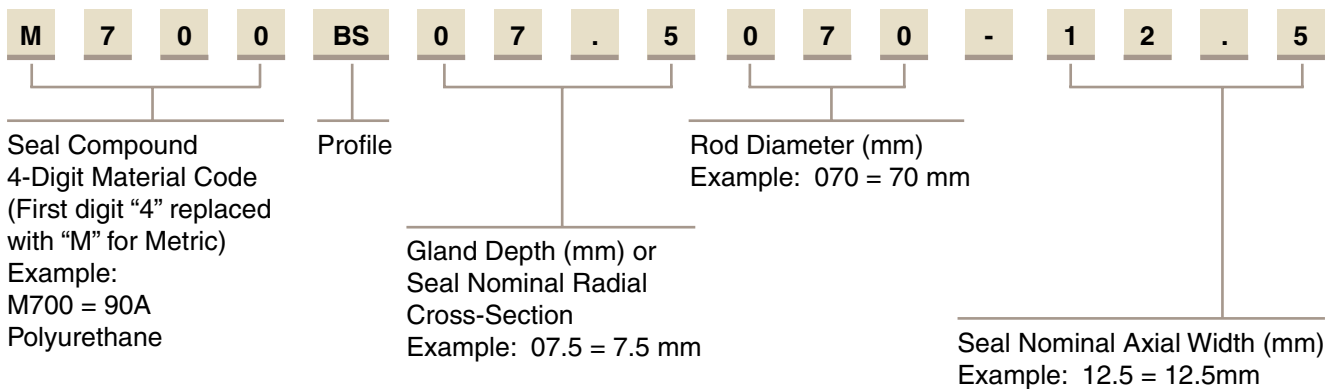

### Gland Dimensions — BS Profile

BS gland dimensions are provided in Table 5-15 on page 5-15.

# Rod Seal B3 Profile

Catalog EPS 5370/USA



**B3 Cross-Section**

## B3 Profile, U-cup Rod Seal

The B3 profile is a non-symmetrical design for use in hydraulic rod sealing applications. The diameter of the B3 profile is designed to ensure a tight static side seal when installed. The knife trimmed, beveled lip does an excellent job wiping fluid film. The B3 profile is available in Parker proprietary compounds offering extrusion resistance, long wear, and low compression set. The B3 profile is designed for use as a stand alone rod seal and can be used with Parker's BR or OD profile buffer seals for more critical sealing applications. The B3 profile does not utilize a secondary sealing lip and can be used with a double lip wiper seal, such as the AY profile, to provide a multiple lip, rod sealing system without trapping pressure.

5

## Technical Data

Standard Materials*	Temperature Range	Pressure Range†	Surface Speed
P4300A90	-65°F to 275°F (-54°C to 135°C)	5000 psi (344 bar)	< 1.6 ft/s (0.5 m/s)
P4301A90	-65°F to 275°F (-54°C to 135°C)	5000 psi (344 bar)	< 1.6 ft/s (0.5 m/s)
P4700A90	-65°F to 200°F (-54°C to 93°C)	5000 psi (344 bar)	< 1.6 ft/s (0.5 m/s)
P5065A88	-70°F to 200°F (-57°C to 93°C)	3500 psi (241 bar)	< 1.6 ft/s (0.5 m/s)

**\*Alternate Materials:** For applications that may require an alternate material, please contact your local Parker Seal representative.

**†Pressure Range** without wear rings (see Table 2-4, page 2-5).

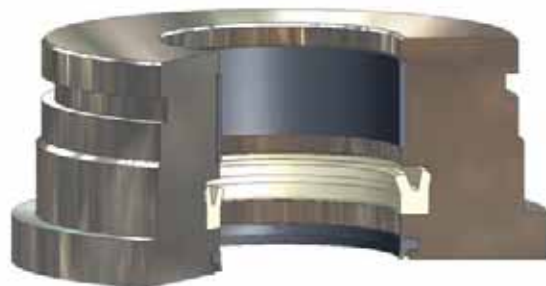

**B3 Installed in Rod Gland**

09/01/07

## B3 Profile

### Part Number Nomenclature — B3 Profile

Table 5-8. B3 Profile — Inch

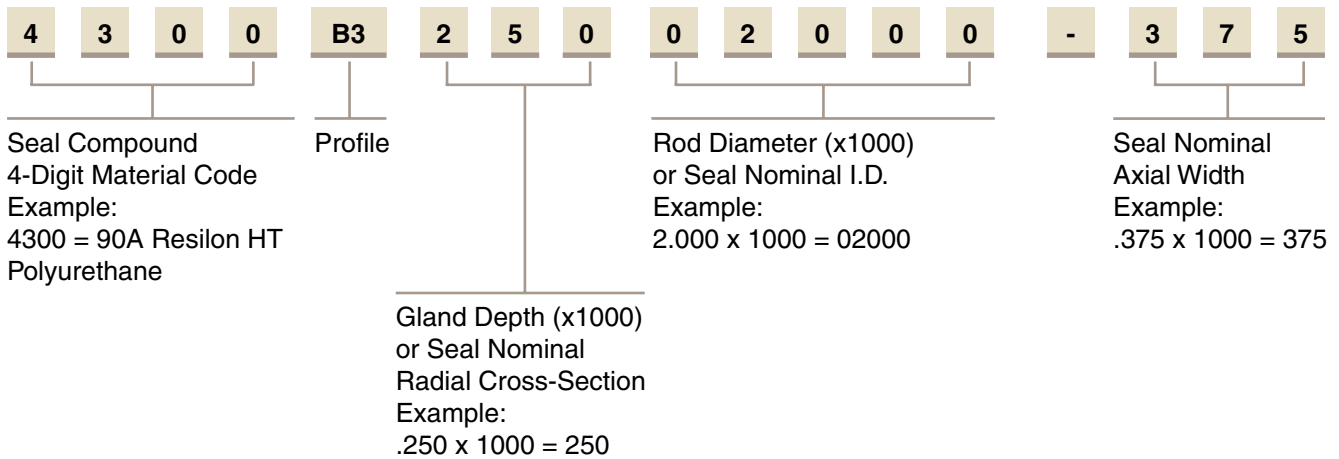

## 5

### Part Number Nomenclature — B3 Profile

Table 5-9. B3 Profile — Metric

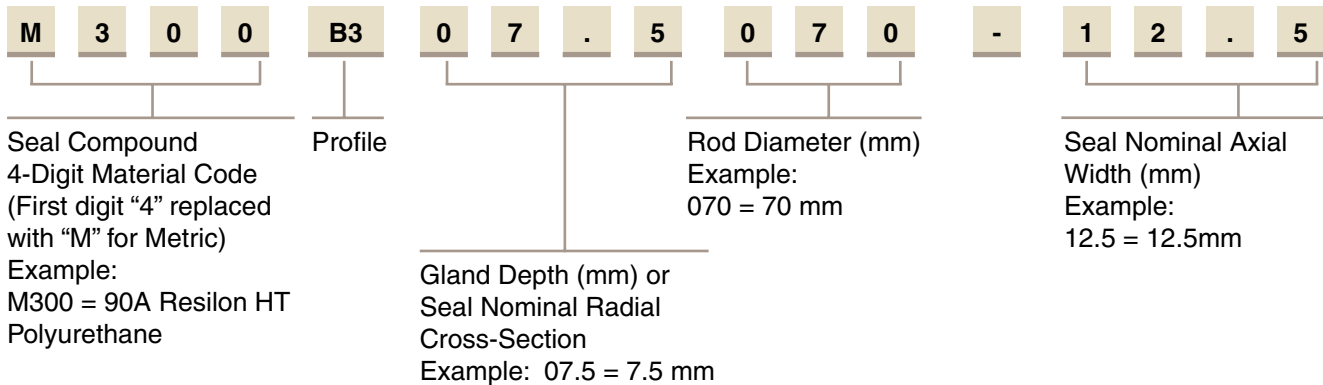

### Gland Dimensions — B3 Profile

B3 gland dimensions are provided in Table 5-12 on page 5-15.

# Rod Seal UR Profile

Catalog EPS 5370/USA



## UR Profile, Industrial U-cup Rod Seal

The UR profile is a non-symmetrical, hydraulic cylinder rod seal. The knife trimmed, beveled lip faces the rod to provide enhanced low to high pressure sealing and wiping action. The UR profile is an economical choice, available in Parker's wear and extrusion resistant Molythane compound.

5

### Technical Data

Standard Materials*	Temperature Range	Pressure Range†	Surface Speed
P4615A90	-65°F to 200°F (-54°C to 93°C)	5000 psi (344 bar)	< 1.6 ft/s (0.5 m/s)

\***Alternate Materials:** For applications that may require an alternate material, please contact your local Parker Seal representative.

†**Pressure Range** without wear rings (see Table 2-4, page 2-5).



*UR Cross-Section*

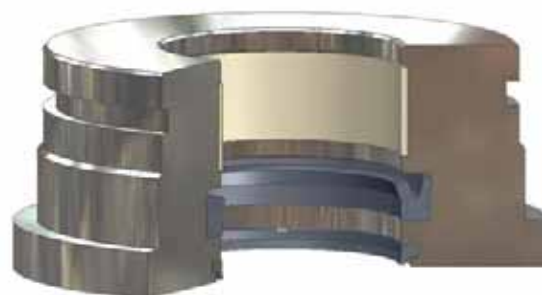

*UR Installed in Rod Gland*

09/01/07

## UR Profile

### Part Number Nomenclature — UR Profile

Table 5-10. UR Profile — Inch

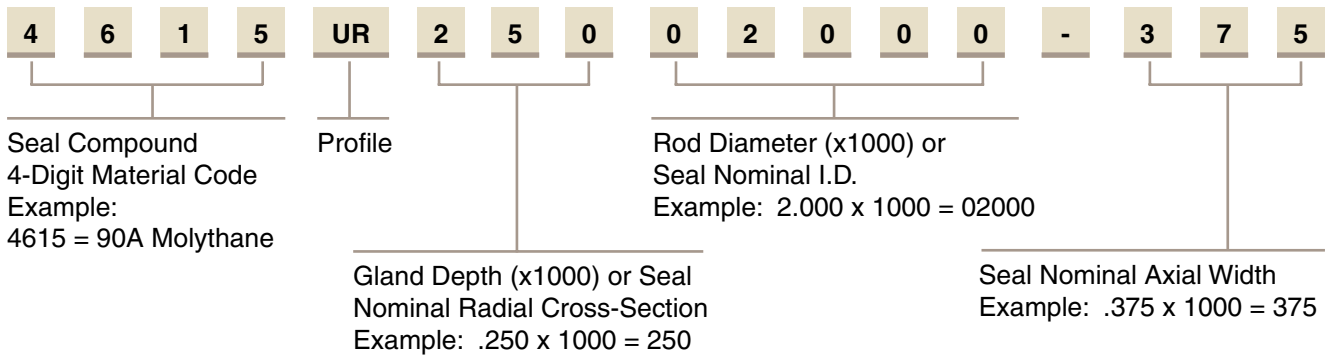

### Gland Dimensions — UR Profile

UR gland dimensions are provided in Table 5-12 on page 5-15.

5



# Rod Seal BD, BT, BS, B3 and UR Gland Dimensions

Catalog EPS 5370/USA

## Gland Dimensions — BD, BT, BS, B3 and UR Profiles — Inch

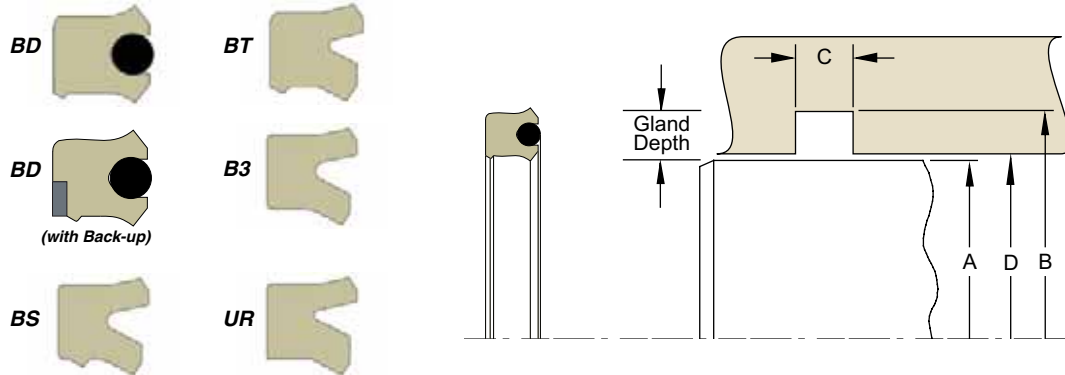

Table 5-11. Gland Dimension Tolerances

Nominal Gland Depth	A Rod Diameter	B Groove Diameter	C Groove Width	D Throat Diameter
1/8	+0.000/-0.001	+0.002/-0.000	+0.015/-0.000	+0.002/-0.000
3/16	+0.000/-0.002	+0.002/-0.000		+0.002/-0.000
1/4	+0.000/-0.002	+0.003/-0.000		+0.003/-0.000
5/16	+0.000/-0.002	+0.004/-0.000		+0.003/-0.000
3/8	+0.000/-0.002	+0.005/-0.000		+0.004/-0.000
7/16	+0.000/-0.003	+0.006/-0.000		+0.004/-0.000
1/2	+0.000/-0.003	+0.007/-0.000		+0.005/-0.000
5/8	+0.000/-0.003	+0.009/-0.000		+0.006/-0.000
3/4	+0.000/-0.004	+0.011/-0.000		+0.007/-0.000
1	+0.000/-0.005	+0.015/-0.000		+0.009/-0.000

Please refer to Engineering Section 2, Page 2-8 for surface finish and additional hardware considerations.

5

Table 5-12. BD, BT, BS, B3 and UR Gland Dimensions — Inch

A Rod Diameter	B Groove Diameter	C Groove Width	D Throat Diameter*	Compounds (X = Standard Offering)											Part Number					
				BD				BT		BS			B3		UR	Compound Code	Profile Code	Ener-gizer Code (BD)		
				4300	4700	5065	With Back-up	4300	4300	4700	4615	5065	4300	5065	4615					
0.219	0.469	0.248	0.220					X								XXXX	xx	12500219	-	225
0.250	0.500	0.206	0.251	X		X		X							X	XXXX	xx	12500250	-	187
0.312	0.562	0.206	0.313	X		X		X								XXXX	xx	12500312	-	187
0.375	0.625	0.206	0.376					X								XXXX	xx	12500375	-	187
0.437	0.687	0.138	0.438												X	XXXX	xx	12500437	-	125
0.437	0.687	0.206	0.438					X								XXXX	xx	12500437	-	187
0.500	0.687	0.172	0.501								X					XXXX	xx	09300500	-	156
0.500	0.750	0.206	0.501	X		X	X	X	X		X					XXXX	xx	12500500	-	187
0.500	0.750	0.275	0.501					X	X		X					XXXX	xx	12500500	-	250
0.500	1.000	0.413	0.501							X	X					XXXX	xx	25000500	-	375
0.562	0.812	0.275	0.563						X			X				XXXX	xx	12500562	-	250
0.625	0.875	0.275	0.626					X	X		X	X			X	XXXX	xx	12500625	-	250
0.625	1.000	0.303	0.626					X								XXXX	xx	18700625	-	275
0.625	1.000	0.343	0.626	X		X		X								XXXX	xx	18700625	-	312

\*If used with wear rings, refer to wear ring throat diameter, see Section 9. For custom groove calculations, see Appendix C.

09/01/07



**Table 5-12. BD, BT, BS, B3 and UR Gland Dimensions — Inch (Continued)**

A Rod Dia- meter	B Groove Dia- meter	C Groove Width	D Throat Dia- meter*	Compounds (X = Standard Offering)											Part Number								
				BD				BT	BS				B3		UR	Com- pound Code	Profile Code	Ener- gizer Code (BD)					
				4300	4700	5065	With Back-up	4300	4300	4700	4615	5065	4300	5065	4615								
0.687	1.062	0.206	0.626														X	XXXX	xx	18700687	-	187	
0.750	1.000	0.275	0.751	X		X			X	X		X	X					X	XXXX	xx	12500750	-	250
0.750	1.125	0.275	0.751						X										XXXX	xx	18700750	-	250
0.750	1.125	0.343	0.751														X	XXXX	xx	18700750	-	312	
0.812	1.187	0.206	0.813														X	XXXX	xx	18700812	-	187	
0.812	1.187	0.275	0.813						X									XXXX	xx	18700812	-	250	
0.875	1.125	0.275	0.876						X		X		X				X	XXXX	xx	12500875	-	250	
0.875	1.250	0.275	0.876								X	X	X					XXXX	xx	18700875	-	250	
0.937	1.312	0.343	0.938								X		X					XXXX	xx	18700937	-	312	
1.000	1.250	0.206	1.001						X	X	X	X	X					XXXX	xx	12501000	-	187	
1.000	1.250	0.275	1.001	X	X	X	X	X	X	X	X	X	X				X	XXXX	xx	12501000	-	250	
1.000	1.312	0.241	1.001						X									XXXX	xx	15601000	-	219	
1.000	1.312	0.275	1.001							X	X	X						XXXX	xx	15601000	-	250	
1.000	1.375	0.275	1.001							X	X	X					X	XXXX	xx	18701000	-	250	
1.000	1.375	0.343	1.001	X		X	X	X	X	X	X	X	X				X	XXXX	xx	18701000	-	312	
1.000	1.500	0.275	1.001														X	XXXX	xx	25001000	-	250	
1.000	1.500	0.413	1.001						X		X						X	XXXX	xx	25001000	-	375	
1.125	1.375	0.138	1.126											X	X			XXXX	xx	12501125	-	125	
1.125	1.375	0.275	1.126						X				X					XXXX	xx	12501125	-	250	
1.125	1.500	0.275	1.126						X								X	XXXX	xx	18701125	-	250	
1.125	1.500	0.343	1.126	X		X	X	X	X		X	X	X				X	XXXX	xx	18701125	-	312	
1.125	1.500	0.413	1.126	X		X												XXXX	xx	18701125	-	375	
1.125	1.625	0.413	1.126						X									XXXX	xx	25001125	-	375	
1.187	1.562	0.343	1.188														X	XXXX	xx	18701187	-	312	
1.250	1.500	0.275	1.251						X	X			X				X	XXXX	xx	12501250	-	250	
1.250	1.562	0.240	1.251						X									XXXX	xx	15601250	-	218	
1.250	1.625	0.275	1.251														X	XXXX	xx	18701250	-	250	
1.250	1.625	0.343	1.251	X	X	X	X	X	X	X	X	X	X				X	XXXX	xx	18701250	-	312	
1.250	1.625	0.413	1.251							X		X						XXXX	xx	18701250	-	375	
1.250	1.750	0.413	1.251						X		X	X					X	XXXX	xx	25001250	-	375	
1.375	1.625	0.206	1.376							X	X	X						XXXX	xx	12501375	-	187	
1.375	1.625	0.275	1.376							X		X	X				X	XXXX	xx	12501375	-	250	
1.375	1.687	0.241	1.376						X									XXXX	xx	15601375	-	219	
1.375	1.687	0.275	1.376							X	X	X						XXXX	xx	15601375	-	250	
1.375	1.687	0.343	1.376						X	X								XXXX	xx	15601375	-	312	
1.375	1.750	0.275	1.376						X								X	XXXX	xx	18701375	-	250	
1.375	1.750	0.343	1.376	X	X	X		X	X	X	X	X					X	XXXX	xx	18701375	-	312	
1.375	1.875	0.413	1.376						X	X		X					X	XXXX	xx	25001375	-	375	
1.500	1.750	0.206	1.501	X		X			X	X	X	X						XXXX	xx	12501500	-	187	
1.500	1.750	0.275	1.501						X									XXXX	xx	12501500	-	250	
1.500	1.875	0.275	1.501						X								X	XXXX	xx	18701500	-	250	
1.500	1.875	0.309	1.501							X		X						XXXX	xx	18701500	-	281	
1.500	1.875	0.343	1.501								X						X	XXXX	xx	18701500	-	312	
1.500	1.875	0.413	1.501	X	X	X	X	X	X		X		X				X	XXXX	xx	18701500	-	375	
1.500	2.000	0.343	1.501														X	XXXX	xx	25001500	-	312	
1.500	2.000	0.413	1.501	X		X	X	X	X	X	X	X					X	XXXX	xx	25001500	-	375	
1.562	1.937	0.343	1.563						X			X						XXXX	xx	18701562	-	312	
1.625	2.000	0.309	1.626								X							XXXX	xx	18701625	-	281	

\*If used with wear rings, refer to wear ring throat diameter, see Section 9.  
For custom groove calculations, see Appendix C.





**Table 5-12. BD, BT, BS, B3 and UR Gland Dimensions — Inch (Continued)**

A Rod Diameter	B Groove Diameter	C Groove Width	D Throat Diameter*	Compounds (X = Standard Offering)												Part Number					
				BD				BT	BS				B3		UR	Compound Code	Profile Code	Part Number	Ener-gizer Code (BD)		
				4300	4700	5065	With Back-up	4300	4300	4700	4615	5065	4300	5065	4615						
1.625	2.000	0.413	1.626	X		X	X	X	X	X						X	XXXX	xx	18701625	-	375
1.625	2.125	0.413	1.626						X							X	XXXX	xx	25001625	-	375
1.750	2.125	0.275	1.751					X									XXXX	xx	18701750	-	250
1.750	2.125	0.343	1.751					X			X						XXXX	xx	18701750	-	312
1.750	2.125	0.413	1.751	X	X	X	X	X	X	X	X	X			X		XXXX	xx	18701750	-	375
1.750	2.250	0.413	1.751	X	X	X	X	X	X	X	X	X			X		XXXX	xx	25001750	-	375
1.750	2.375	0.550	1.752					X									XXXX	xx	31201750	-	500
1.875	2.250	0.343	1.876						X			X					XXXX	xx	18701875	-	312
1.875	2.250	0.413	1.876	X		X	X	X	X		X	X					XXXX	xx	18701875	-	375
2.000	2.250	0.206	2.001								X	X	X				XXXX	xx	12502000	-	187
2.000	2.375	0.275	2.001					X									XXXX	xx	18702000	-	250
2.000	2.375	0.309	2.001							X		X					XXXX	xx	18702000	-	281
2.000	2.375	0.343	2.001					X			X		X	X	X		XXXX	xx	18702000	-	312
2.000	2.375	0.413	2.001	X	X	X	X	X	X	X	X	X			X		XXXX	xx	18702000	-	375
2.000	2.500	0.413	2.001	X	X	X	X	X	X	X	X	X			X		XXXX	xx	25002000	-	375
2.000	2.625	0.550	2.002						X		X						XXXX	xx	31202000	-	500
2.125	2.500	0.413	2.126								X						XXXX	xx	18702125	-	375
2.125	2.625	0.413	2.126					X		X		X					XXXX	xx	25002125	-	375
2.250	2.625	0.206	2.251										X	X			XXXX	xx	18702250	-	187
2.250	2.625	0.309	2.251												X		XXXX	xx	18702250	-	281
2.250	2.625	0.343	2.251					X									XXXX	xx	18702250	-	312
2.250	2.625	0.413	2.251	X		X	X		X	X	X	X					XXXX	xx	18702250	-	375
2.250	2.750	0.413	2.251	X	X	X	X	X	X	X	X	X			X		XXXX	xx	25002250	-	375
2.250	2.875	0.413	2.252							X		X					XXXX	xx	31202250	-	375
2.250	2.875	0.550	2.252							X		X	X	X	X		XXXX	xx	31202250	-	500
2.250	2.875	0.877	2.252					X									XXXX	xx	31202250	-	797
2.375	2.875	0.413	2.376					X									XXXX	xx	25002375	-	375
2.500	2.875	0.413	2.501	X	X	X	X	X	X		X				X		XXXX	xx	18702500	-	375
2.500	2.937	0.309	2.501					X									XXXX	xx	21802500	-	281
2.500	2.937	0.343	2.501					X									XXXX	xx	21802500	-	312
2.500	2.937	0.413	2.501					X									XXXX	xx	21802500	-	375
2.500	3.000	0.413	2.501	X	X	X	X	X	X	X	X	X			X		XXXX	xx	25002500	-	375
2.500	3.125	0.550	2.502						X	X	X	X	X	X	X		XXXX	xx	31202500	-	500
2.625	3.000	0.413	2.626						X		X						XXXX	xx	18702625	-	375
2.625	3.125	0.413	2.626	X		X		X	X		X	X					XXXX	xx	25002625	-	375
2.750	3.125	0.309	2.751							X		X	X	X			XXXX	xx	18702750	-	281
2.750	3.250	0.413	2.751	X	X	X	X	X		X	X	X			X		XXXX	xx	25002750	-	375
2.750	3.375	0.550	2.752						X	X	X	X	X	X			XXXX	xx	31202750	-	500
2.750	3.500	0.688	2.752						X	X	X	X					XXXX	xx	37502750	-	625
2.875	3.250	0.206	2.876									X	X				XXXX	xx	18702875	-	187
2.875	3.250	0.413	2.876					X									XXXX	xx	18702875	-	375
2.875	3.375	0.413	2.876	X		X											XXXX	xx	25002875	-	375
3.000	3.375	0.309	3.001							X		X					XXXX	xx	18703000	-	281
3.000	3.375	0.413	3.001					X									XXXX	xx	18703000	-	375
3.000	3.437	0.309	3.001					X									XXXX	xx	21803000	-	281
3.000	3.500	0.413	3.001	X	X	X	X	X	X	X	X	X			X		XXXX	xx	25003000	-	375
3.000	3.625	0.550	3.002						X			X			X		XXXX	xx	31203000	-	500
3.000	3.750	0.550	3.002						X			X					XXXX	xx	37503000	-	500

\*If used with wear rings, refer to wear ring throat diameter, see Section 9.  
 For custom groove calculations, see Appendix C.



**Table 5-12. BD, BT, BS, B3 and UR Gland Dimensions — Inch (Continued)**

A Rod Dia- meter	B Groove Dia- meter	C Groove Width	D Throat Dia- meter*	Compounds (X = Standard Offering)											Part Number					
				BD				BT	BS			B3		UR	Com- pound Code	Profile Code	Ener- gizer Code (BD)			
				4300	4700	5065	With Back-up	4300	4300	4700	4615	5065	4300	5065					4615	
3.000	3.750	0.688	3.002								X	X				XXXX	xx	37503000	-	625
3.250	3.625	0.413	3.251								X	X				XXXX	xx	18703250	-	375
3.250	3.750	0.413	3.251		X			X	X	X	X				X	XXXX	xx	25003250	-	375
3.500	3.875	0.309	3.501							X	X					XXXX	xx	18703500	-	281
3.500	3.875	0.413	3.501					X								XXXX	xx	18703500	-	375
3.500	4.000	0.343	3.501					X								XXXX	xx	25003500	-	312
3.500	4.000	0.413	3.501					X	X	X	X			X		XXXX	xx	25003500	-	375
3.500	4.125	0.550	3.502						X		X					XXXX	xx	31203500	-	500
3.500	4.250	0.550	3.502											X		XXXX	xx	37503500	-	500
3.500	4.250	0.688	3.502							X	X			X		XXXX	xx	37503500	-	625
3.750	4.250	0.413	3.751					X								XXXX	xx	25003750	-	375
3.750	4.375	0.550	3.752					X								XXXX	xx	31203750	-	500
3.875	4.250	0.343	3.876					X								XXXX	xx	18703785	-	312
3.875	4.750	0.825	3.877								X					XXXX	xx	43703875	-	750
4.000	4.375	0.413	4.001					X								XXXX	xx	18704000	-	375
4.000	4.500	0.343	4.001					X								XXXX	xx	25004000	-	312
4.000	4.500	0.413	4.001	X	X	X	X	X	X	X	X	X	X	X	X	XXXX	xx	25004000	-	375
4.000	4.500	0.618	4.001					X	X	X	X			X		XXXX	xx	25004000	-	562
4.000	4.625	0.413	4.002					X								XXXX	xx	31204000	-	375
4.000	4.750	0.688	4.002					X	X	X	X			X		XXXX	xx	37504000	-	625
4.250	4.625	0.309	4.251							X	X					XXXX	xx	18704250	-	281
4.250	4.750	0.413	4.251	X		X				X	X					XXXX	xx	25004250	-	375
4.250	4.750	0.618	4.251						X	X	X					XXXX	xx	25004250	-	562
4.250	5.000	0.688	4.252					X								XXXX	xx	37504250	-	625
4.250	5.000	0.784	4.252					X								XXXX	xx	37504250	-	713
4.500	5.000	0.343	4.501					X								XXXX	xx	25004500	-	312
4.500	5.000	0.413	4.501							X	X					XXXX	xx	25004500	-	375
4.500	5.125	0.413	4.502					X								XXXX	xx	31204500	-	375
4.500	5.125	0.550	4.502											X		XXXX	xx	31204500	-	500
4.500	5.250	0.688	4.502					X	X		X					XXXX	xx	37504500	-	625
4.625	5.250	0.688	4.627							X	X					XXXX	xx	31204625	-	625
4.750	5.375	0.550	4.752					X								XXXX	xx	31204750	-	500
4.750	5.625	0.825	4.752								X					XXXX	xx	43704750	-	750
5.000	5.375	0.309	5.001							X	X					XXXX	xx	18705000	-	281
5.000	5.375	0.413	5.001					X								XXXX	xx	18705000	-	375
5.000	5.500	0.413	5.001					X	X	X	X					XXXX	xx	25005000	-	375
5.000	5.500	0.618	5.001					X								XXXX	xx	25005000	-	562
5.000	5.500	0.792	5.001							X	X					XXXX	xx	25005000	-	720
5.000	5.562	0.378	5.001					X								XXXX	xx	28105000	-	344
5.000	5.562	0.550	5.001											X		XXXX	xx	28105000	-	500
5.000	5.750	0.550	5.002								X					XXXX	xx	37505000	-	500
5.000	5.750	0.688	5.002					X						X		XXXX	xx	37505000	-	625
5.250	6.000	0.688	5.252					X	X		X					XXXX	xx	37505250	-	625
5.500	6.125	0.413	5.502					X								XXXX	xx	31205500	-	375
5.500	6.250	0.688	5.502					X								XXXX	xx	37505500	-	625
5.750	6.250	0.413	5.751							X	X					XXXX	xx	25005750	-	375
6.000	6.500	0.618	6.001					X	X	X	X					XXXX	xx	25006000	-	562
6.000	6.500	0.792	6.001							X	X					XXXX	xx	25006000	-	720

\*If used with wear rings, refer to wear ring throat diameter, see Section 9.  
For custom groove calculations, see Appendix C.









# Rod Seal E5 Profile

Catalog EPS 5370/USA



*E5 Cross-Section*

## E5 Profile, Premium Rounded Lip U-cup Rod Seal

Parker's E5 profile is a non-symmetrical rod seal designed to seal both lubricated and non-lubricated air. To ensure that critical surfaces retain lubrication, the radius edge of the lip is designed to hydroplane over pre-lubricated surfaces. The standard compound for the E5 profile is Parker's proprietary Nitroxile ELF compound N4274A85. This compound is formulated with proprietary internal lubricants to provide "Extreme Low Friction" and excellent wear resistance. This compound provides extended cycle life over standard nitrile and carboxylated nitrile compounds.

5

### Technical Data

Standard Materials*	Temperature Range	Pressure Range†	Surface Speed
N4274A85	-10°F to 250°F (-23°C to 121°C)	250 psi (17 bar)	< 3 ft/s (1 m/s)
N4180A80	-40°F to 250°F (-40°C to 121°C)	250 psi (17 bar)	< 3 ft/s (1 m/s)
V4208A90	-5°F to 400°F (-21°C to 204°C)	250 psi (17 bar)	< 3 ft/s (1 m/s)
P5065A88	-70°F to 200°F (-57°C to 93°C)	250 psi (17 bar)	< 3 ft/s (1 m/s)

**\*Alternate Materials:** For applications that may require an alternate material, please contact your local Parker Seal representative.

**†Pressure Range** without wear rings (see Table 2-4, page 2-5).

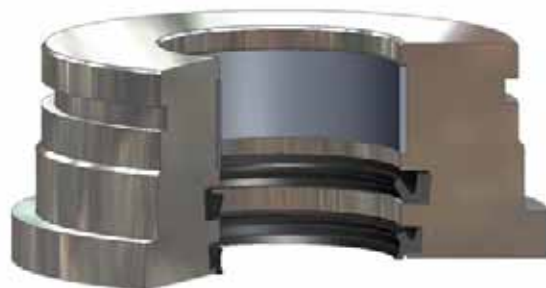

*E5 Installed in Rod Gland*

09/01/07

## E5 Profile

### Part Number Nomenclature — E5 Profile

Table 5-14. E5 Profile — Inch

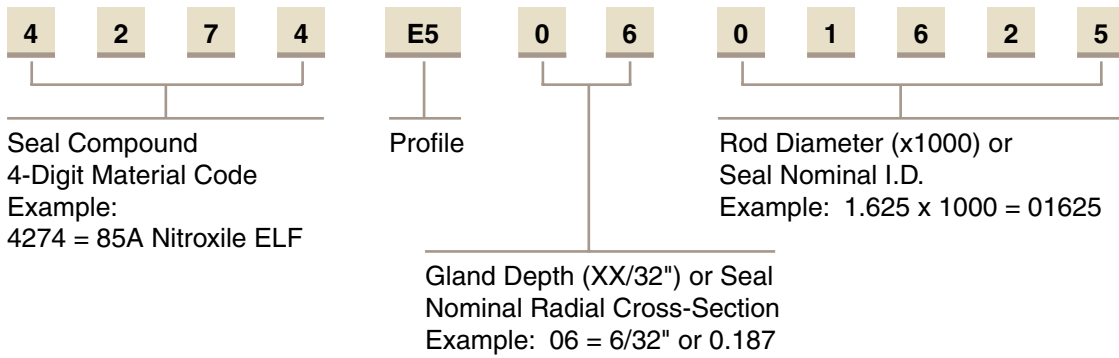

### Gland Dimensions — E5 Profile

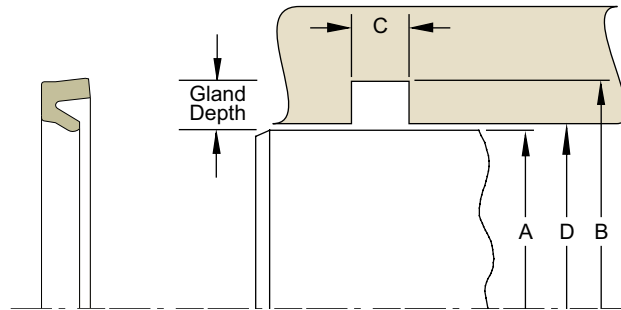

Table 5-15. Gland Dimension Tolerances

Nominal Gland Depth	A Rod Diameter	B Groove Diameter	C Groove Width	D Throat Diameter
1/8	+0.00/-0.001	+0.02/-0.000	+0.015/-0.000	+0.02/-0.000
3/16	+0.00/-0.002	+0.02/-0.000		+0.02/-0.000
1/4	+0.00/-0.002	+0.03/-0.000		+0.03/-0.000
5/16	+0.00/-0.002	+0.04/-0.000		+0.03/-0.000
3/8	+0.00/-0.002	+0.05/-0.000		+0.04/-0.000
7/16	+0.00/-0.003	+0.06/-0.000		+0.04/-0.000
1/2	+0.00/-0.003	+0.07/-0.000		+0.05/-0.000
5/8	+0.00/-0.003	+0.09/-0.000		+0.06/-0.000
3/4	+0.00/-0.004	+0.11/-0.000		+0.07/-0.000
1	+0.00/-0.005	+0.15/-0.000		+0.09/-0.000

Please refer to Engineering Section 2, Page 2-8 for surface finish and additional hardware considerations.

Table 5-16. E5 Gland Dimensions — Inch

A Rod Diameter	B Groove Diameter	C Groove Width	D Throat Diameter*	Compounds (X = Standard Offering)				Part Number	
				4180	4274	4208	5065	Compound Code	
0.125	0.375	0.156	0.126		X			XXXX	E50400125
0.187	0.375	0.125	0.188		X			XXXX	E50300187
0.250	0.500	0.156	0.251		X			XXXX	E50400250
0.375	0.625	0.156	0.376		X			XXXX	E50400375
0.500	0.750	0.156	0.501	X	X	X		XXXX	E50400500
0.625	0.875	0.156	0.626	X	X	X	X	XXXX	E50400625
0.750	1.000	0.156	0.751	X	X	X	X	XXXX	E50400750
0.875	1.125	0.156	0.876		X			XXXX	E50400875

\*If used with wear rings, refer to wear ring throat diameter, see Section 9.  
For custom groove calculations, see Appendix C.

**Table 5-16. E5 Gland Dimensions — Inch (Continued)**

A Rod Diameter	B Groove Diameter	C Groove Width	D Throat Diameter*	Compounds (X = Standard Offering)				Part Number	
				4180	4274	4208	5065	Compound Code	
1.000	1.250	0.156	1.001		X	X	X	XXXX	E50401000
1.000	1.312	0.188	1.001		X	X	X	XXXX	E50501000
1.250	1.500	0.156	1.251		X			XXXX	E50401250
1.250	1.562	0.188	1.251	X	X			XXXX	E50501250
1.375	1.687	0.188	1.376		X	X		XXXX	E50501375
1.375	1.750	0.218	1.377	X	X	X	X	XXXX	E50601375
1.500	1.875	0.218	1.502		X			XXXX	E50601500
1.750	2.125	0.218	1.752		X	X		XXXX	E50601750
2.000	2.375	0.218	2.002		X	X		XXXX	E50602000
2.500	2.875	0.218	2.502		X			XXXX	E50602500

\*If used with wear rings, refer to wear ring throat diameter, see Section 9.

For custom groove calculations, see Appendix C.

NOTE: For sizes larger than those shown in the table, please contact your local Parker Seal representative.

**Part Number Nomenclature — E5 Profile**

**Table 5-17. E5 Profile — Metric**

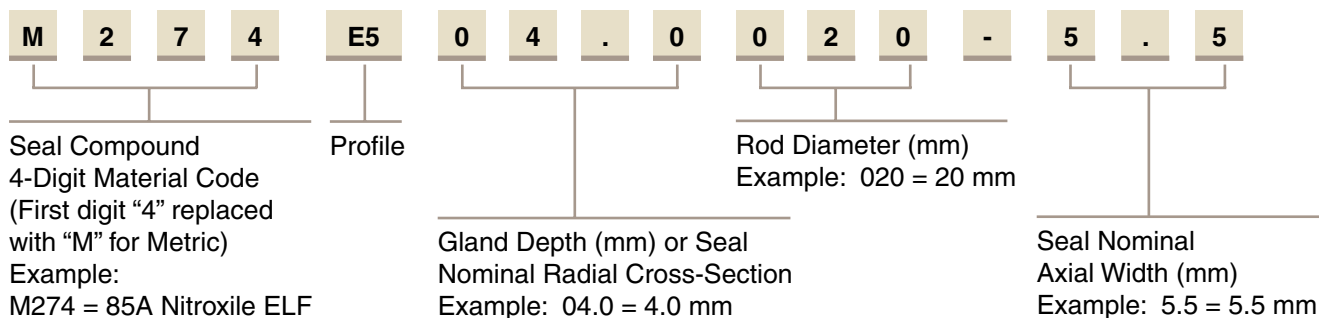

**Gland Dimensions — E5 Profile**

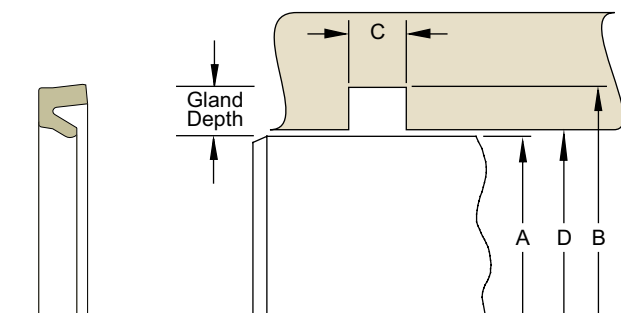

**Table 5-18. E5 Gland Dimensions — Metric (mm)**

A Rod Diameter	B Groove Diameter	C Groove Width	D Throat Diameter*	Compounds (X = Standard Offering)				Part Number	
				M180	M274	M208	M065	Compound Code	
f7	H9	+.25/-0.00	H8						
For ISO tolerances refer to Appendix F.									
14.0	22.0	5.5	14.0	X				XXXX	E504.0014-5
20.0	28.0	6.0	20.0		X			XXXX	E504.0020-5.5
25.0	35.0	7.5	25.0		X			XXXX	E505.0025-7
30.0	38.0	5.0	30.0		X			XXXX	E504.0030-4.3
50.0	60.0	10.5	50.0		X	X		XXXX	E505.0050-9.5

\*If used with wear rings, refer to wear ring throat diameter, see Section 9.

For custom groove calculations, see Appendix C.

NOTE: For sizes larger than those shown in the table, please contact your local Parker Seal representative.

09/01/07



# Rod Seal TR Profile

Catalog EPS 5370/USA

## TR Profile (Rod T-seal) Compact Seal with Anti-Extrusion Technology



Parker's rod T-seal is designed to retrofit o-rings in no back-up, single back-up and two back-up standard industrial reciprocating glands. Its compact design provides improved stability and extrusion resistance in dynamic fluid sealing applications. The flange or base of the T-seal forms a tight seal in the gland and supports the anti-extrusion back-up rings. When energized, the back-up rings bridge the extrusion gap to protect the rubber sealing element from extrusion and system contamination. The rod T-seal eliminates the spiral or twisting failure that can occur when o-rings are used against a dynamic surface. Parker offers the rod T-seal in a variety of elastomer and back-up ring compounds to cover a wide range of fluid compatibility, pressure and temperature requirements.

Profile **TR0** for **no** back-up o-ring gland (standard offering)  
Profile **TRS** for **single** back-up o-ring gland  
Profile **TRT** for **two** back-up o-ring gland

The TR profile is sold only as an assembly (elastomer and back-ups).

## Technical Data

### Standard Materials

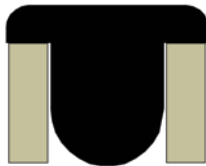

TR Cross-Section

Base	Temperature Range	Surface Speed
<b>Elastomer*</b>		
N4115A75	-40°F to 225F (-40°C to 107°C)	< 1.6 ft/s (0.5 m/s)
N4274A85	-10°F to 250°F (-23°C to 121°C)	< 1.6 ft/s (0.5 m/s)
V4205A75	-20°F to 400°F (-29°C to 204°C)	< 1.6 ft/s (0.5 m/s)
E4259A80	-65°F to 300°F (-54°C to 149°C)	< 1.6 ft/s (0.5 m/s)

**\*Alternate Materials:** For applications that may require an alternate material, please contact your local Parker Seal representative.



TR Installed in Rod Gland

09/01/07

## Technical Data (Continued)

### Standard Materials

#### Back-up Rings\*\*

	Temperature Range	Pressure Range†
B001 (Nylatron)	-65°F to 250°F (-54°C to 121°C)	5,000 psi (344 bar)
B011 (Virgin PTFE)	-20°F to 250°F (-29°C to 121°C)	3,000 psi (206 bar)
B085 (PEEK)	-65°F to 500°F (-54°C to 260°C)	10,000 psi (689 bar)

\*\*Alternate Materials: For applications that may require an alternate material, please see Section 3 for alternate materials.

†Pressure Range without wear rings (see Table 2-4, page 2-5).

## Part Number Nomenclature — TR Profile

Table 5-19. TR Profile — Inch

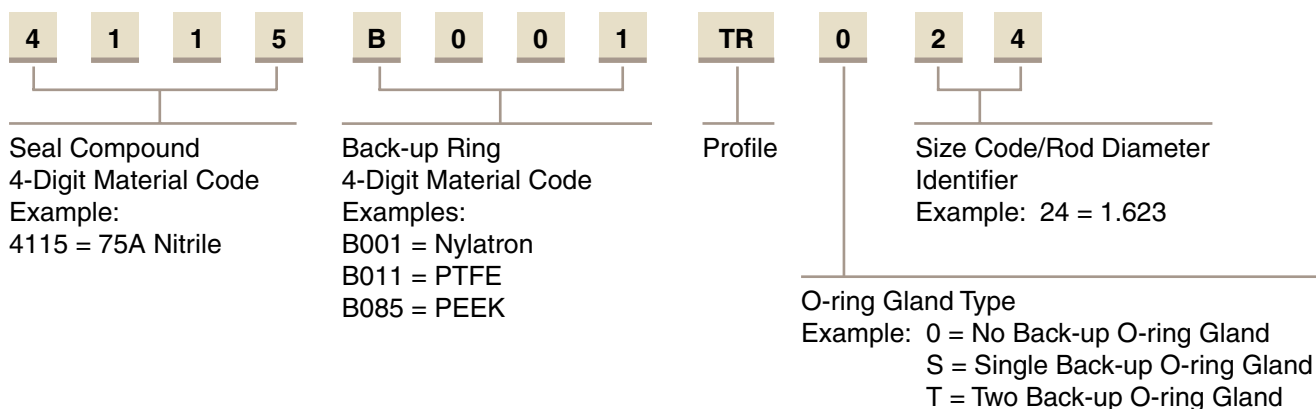

## Gland Dimensions — TR Profile

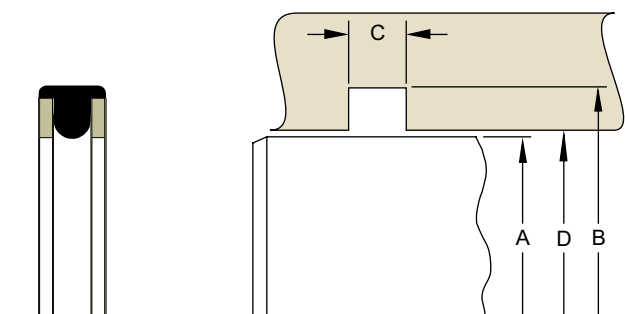

Please refer to Engineering Section 2, Page 2-8 for surface finish and additional hardware considerations.

Table 5-20. TR Gland Dimensions — Inch

A Rod Diameter	B Groove Diameter	C			D Throat Diameter*	Ref O-ring Dash Number	Compounds (X = Standard Offering)				Part Number				
		TR0 Groove Width	TRS Groove Width	TRT Groove Width			4115	4274	4205	4259	Com- pound Code	Back-up Ring Code	Groove Width Code**	Size Code	
+0.000/ -0.002	+0.002/ -0.000	+0.005/ -0.000	+0.005/ -0.000	+0.005/ -0.000	+0.001/ -0.000										
0.186	0.362	0.140	0.171	0.238	0.188	106	X		X		XXXX	B0XX	TR0	01	
0.249	0.425	0.140	0.171	0.238	0.251	108	X		X		XXXX	B0XX	TR0	02	
0.311	0.487	0.140	0.171	0.238	0.313	109	X		X		XXXX	B0XX	TR0	03	
0.373	0.615	0.187	0.208	0.275	0.376	204	X	X	X		XXXX	B0XX	TR0	04	

\* If used with wear rings, refer to wear ring throat diameter, see Section 9.

\*\*Chart reflects availability for TR0 only. For availability of TRS and TRT, please contact your local Parker Seal representative. For custom groove calculations, see Appendix C.



**TR Profile**

**Table 5-20. TR Gland Dimensions — Inch\*\* (Continued)**

A Rod Diameter	B Groove Diameter	C			D Throat Diameter*	Ref O-ring Dash Number	Compounds (X = Standard Offering)				Part Number							
		TR0 Groove Width	TRS Groove Width	TRT Groove Width			4115	4274	4205	4259	Com- pound Code	Back-up Ring Code	Groove Width Code**	Size Code				
+0.000/ -0.002	+0.002/ -0.000	+0.005/ -0.000	+0.005/ -0.000	+0.005/ -0.000	+0.001/ -0.000													
0.435	0.677	0.187	0.208	0.275	0.438	205	X		X			XXXX	B0XX	TR0		05		
0.498	0.740	0.187	0.208	0.275	0.501	206	X	X	X			XXXX	B0XX	TR0		06		
0.560	0.802	0.187	0.208	0.275	0.563	207	X		X			XXXX	B0XX	TR0		07		
0.623	0.865	0.187	0.208	0.275	0.626	208	X	X	X	X		XXXX	B0XX	TR0		08		
0.685	0.927	0.187	0.208	0.275	0.688	209	X					XXXX	B0XX	TR0		09		
0.748	0.990	0.187	0.208	0.275	0.751	210	X	X	X	X		XXXX	B0XX	TR0		10		
0.810	1.052	0.187	0.208	0.275	0.813	211	X		X			XXXX	B0XX	TR0		11		
0.873	1.065	0.187	0.208	0.275	0.876	212	X		X			XXXX	B0XX	TR0		12		
0.935	1.177	0.187	0.208	0.275	0.938	213	X		X			XXXX	B0XX	TR0		13		
0.998	1.240	0.187	0.208	0.275	1.001	214	X	X	X			XXXX	B0XX	TR0		14		
1.060	1.302	0.187	0.208	0.275	1.063	215	X					XXXX	B0XX	TR0		15		
1.123	1.365	0.187	0.208	0.275	1.126	216	X		X	X		XXXX	B0XX	TR0		16		
1.185	1.427	0.187	0.208	0.275	1.188	217	X		X			XXXX	B0XX	TR0		17		
1.248	1.490	0.187	0.208	0.275	1.251	218	X	X	X	X		XXXX	B0XX	TR0		18		
1.310	1.552	0.187	0.208	0.275	1.313	219	X					XXXX	B0XX	TR0		19		
1.373	1.615	0.187	0.208	0.275	1.376	220	X		X	X		XXXX	B0XX	TR0		20		
1.435	1.677	0.187	0.208	0.275	1.438	221	X	X				XXXX	B0XX	TR0		21		
1.498	1.740	0.187	0.208	0.275	1.501	222	X	X	X	X		XXXX	B0XX	TR0		22		
1.498	1.868	0.281	0.311	0.410	1.501	325	X		X			XXXX	B0XX	TR0		23		
1.623	1.993	0.281	0.311	0.410	1.626	326	X	X				XXXX	B0XX	TR0		24		
1.748	2.118	0.281	0.311	0.410	1.751	327	X	X	X			XXXX	B0XX	TR0		25		
1.873	2.243	0.281	0.311	0.410	1.876	328	X	X				XXXX	B0XX	TR0		26		
1.998	2.368	0.281	0.311	0.410	2.001	329	X		X	X		XXXX	B0XX	TR0		27		
2.123	2.493	0.281	0.311	0.410	2.126	330	X		X			XXXX	B0XX	TR0		28		
2.248	2.618	0.281	0.311	0.410	2.251	331	X	X				XXXX	B0XX	TR0		29		
2.373	2.743	0.281	0.311	0.410	2.376	332	X		X			XXXX	B0XX	TR0		30		
2.498	2.868	0.281	0.311	0.410	2.501	333	X	X	X			XXXX	B0XX	TR0		31		
2.623	2.993	0.281	0.311	0.410	2.626	334	X		X			XXXX	B0XX	TR0		32		
2.748	3.118	0.281	0.311	0.410	2.751	335	X	X	X			XXXX	B0XX	TR0		33		
2.873	3.243	0.281	0.311	0.410	2.876	336	X					XXXX	B0XX	TR0		34		
2.998	3.368	0.281	0.311	0.410	3.001	337	X					XXXX	B0XX	TR0		35		
3.123	3.493	0.281	0.311	0.410	3.126	338	X					XXXX	B0XX	TR0		36		
3.248	3.618	0.281	0.311	0.410	3.251	339	X		X			XXXX	B0XX	TR0		37		
3.373	3.743	0.281	0.311	0.410	3.376	340	X		X			XXXX	B0XX	TR0		38		
3.498	3.868	0.281	0.311	0.410	3.501	341	X					XXXX	B0XX	TR0		39		
3.623	3.993	0.281	0.311	0.410	3.626	342	X					XXXX	B0XX	TR0		40		
3.748	4.118	0.281	0.311	0.410	3.751	343	X		X			XXXX	B0XX	TR0		41		
3.873	4.243	0.281	0.311	0.410	3.876	344	X					XXXX	B0XX	TR0		42		
3.998	4.368	0.281	0.311	0.410	4.001	345	X		X			XXXX	B0XX	TR0		43		
4.123	4.493	0.281	0.311	0.410	4.126	346	X					XXXX	B0XX	TR0		44		
4.248	4.618	0.281	0.311	0.410	4.251	347	X		X			XXXX	B0XX	TR0		45		
4.373	4.743	0.281	0.311	0.410	4.376	348	X					XXXX	B0XX	TR0		46		
4.498	4.868	0.281	0.311	0.410	4.501	349	X		X			XXXX	B0XX	TR0		47		
4.997	5.471	0.375	0.408	0.538	5.001	429	X		X	X		XXXX	B0XX	TR0		48		
5.247	5.721	0.375	0.408	0.538	5.251	431	X					XXXX	B0XX	TR0		49		
5.497	5.971	0.375	0.408	0.538	5.501	433	X					XXXX	B0XX	TR0		50		

\* If used with wear rings, refer to wear ring throat diameter, see Section 9.

\*\*Chart reflects availability for TR0 only. For availability of TRS and TRT, please contact your local Parker Seal representative. For custom groove calculations, see Appendix C.





Table 5-20. TR Gland Dimensions — Inch\*\* (Continued)

A Rod Diameter	B Groove Diameter	C			D Throat Diameter*	Ref O-ring Dash Number	Compounds (X = Standard Offering)				Part Number			
		TR0 Groove Width	TRS Groove Width	TRT Groove Width			4115	4274	4205	4259	Com- pound Code	Back-up Ring Code	Groove Width Code**	Size Code
+ .000/ - .002	+ .002/ - .000	+ .005/ - .000	+ .005/ - .000	+ .005/ - .000	+ .001/ - .000									
5.622	6.096	0.375	0.408	0.538	5.626	434	X				XXXX	B0XX	TR0	51
5.997	6.471	0.375	0.408	0.538	6.001	437	X				XXXX	B0XX	TR0	52
6.247	6.721	0.375	0.408	0.538	6.251	438	X				XXXX	B0XX	TR0	53
6.497	6.971	0.375	0.408	0.538	6.501	439	X		X		XXXX	B0XX	TR0	54
6.747	7.221	0.375	0.408	0.538	6.751	440	X				XXXX	B0XX	TR0	55
6.997	7.471	0.375	0.408	0.538	7.001	441	X				XXXX	B0XX	TR0	56
7.247	7.721	0.375	0.408	0.538	7.251	442	X				XXXX	B0XX	TR0	57
7.497	7.971	0.375	0.408	0.538	7.501	443	X		X		XXXX	B0XX	TR0	58
7.997	8.471	0.375	0.408	0.538	8.001	445	X				XXXX	B0XX	TR0	59
8.997	9.471	0.375	0.408	0.538	9.001	447	X				XXXX	B0XX	TR0	60
9.497	9.971	0.375	0.408	0.538	9.501	448	X				XXXX	B0XX	TR0	61
9.997	10.471	0.375	0.408	0.538	10.001	449	X				XXXX	B0XX	TR0	62
10.997	11.471	0.375	0.408	0.538	11.001	451	X				XXXX	B0XX	TR0	63
11.497	11.971	0.375	0.408	0.538	11.501	452					XXXX	B0XX	TR0	64
11.997	12.471	0.375	0.408	0.538	12.001	453	X				XXXX	B0XX	TR0	65

\* If used with wear rings, refer to wear ring throat diameter, see Section 9.

\*\*Chart reflects availability for TR0 only. For availability of TRS and TRT, please contact your local Parker Seal representative. For custom groove calculations, see Appendix C.

NOTE: For sizes larger than those shown in the table, please contact your local Parker Seal representative.

# Rod Seal ON Profile

Catalog EPS 5370/USA

5



ON Cross-Section

## ON Profile, PTFE Rod Cap Seal

The Parker ON profile is a bi-directional PTFE rod seal for use in low to medium duty hydraulic systems. The ON profile is a simple two piece design comprised of a standard size Parker o-ring energizing a wear resistant PTFE cap. The ON profile offers long wear and low friction, and because of its short assembly length, requires minimal space in the rod housing. The seal is commonly used in applications such as mobile hydraulics, machine tools, injection molding machines and hydraulic presses. Parker's ON profile will retrofit non-Parker seals of similar design.

The ON profile may be ordered without the energizer by omitting the energizer code. See part number nomenclature.

### Technical Data

Standard Materials* Cap		Temperature Range	Pressure Range†	Surface Speed
0401 40% bronze-filled PTFE		-200°F to 575°F (-129°C to 302°C)	5000 psi (344 bar)	< 13 ft/s (4 m/sec)
<b>Energizer</b>				
A	70A Nitrile	-30°F to 250°F (-34°C to 121°C)		

**\*Alternate Materials:** For applications that may require an alternate material, please see Section 3 for alternate PTFE (Table 3-4) and energizer (Table 3-5) materials.

**†Pressure Range** without wear rings (see Table 2-4, page 2-5).

### Options

**Notched side walls:** Notches can be added to the side walls of the PTFE cap. This can help to optimize the seal's response to fluid pressure. Notched side walls help ensure that fluid pressure fills the cavity between the side face of the seal and the side face of the seal gland. Consult your local Parker Seal representative for the availability and cost to add side notches to the ON profile.

N = Notched walls 

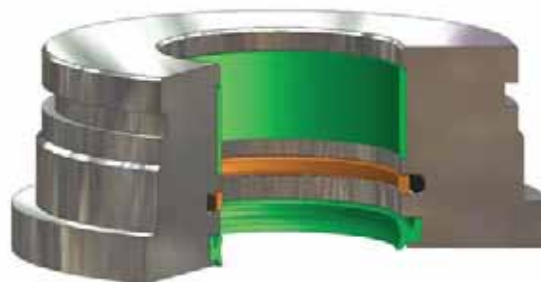

ON installed in Rod Gland

09/01/07

**Part Number Nomenclature — ON Profile**

**Table 5-21. ON Profile — Inch**

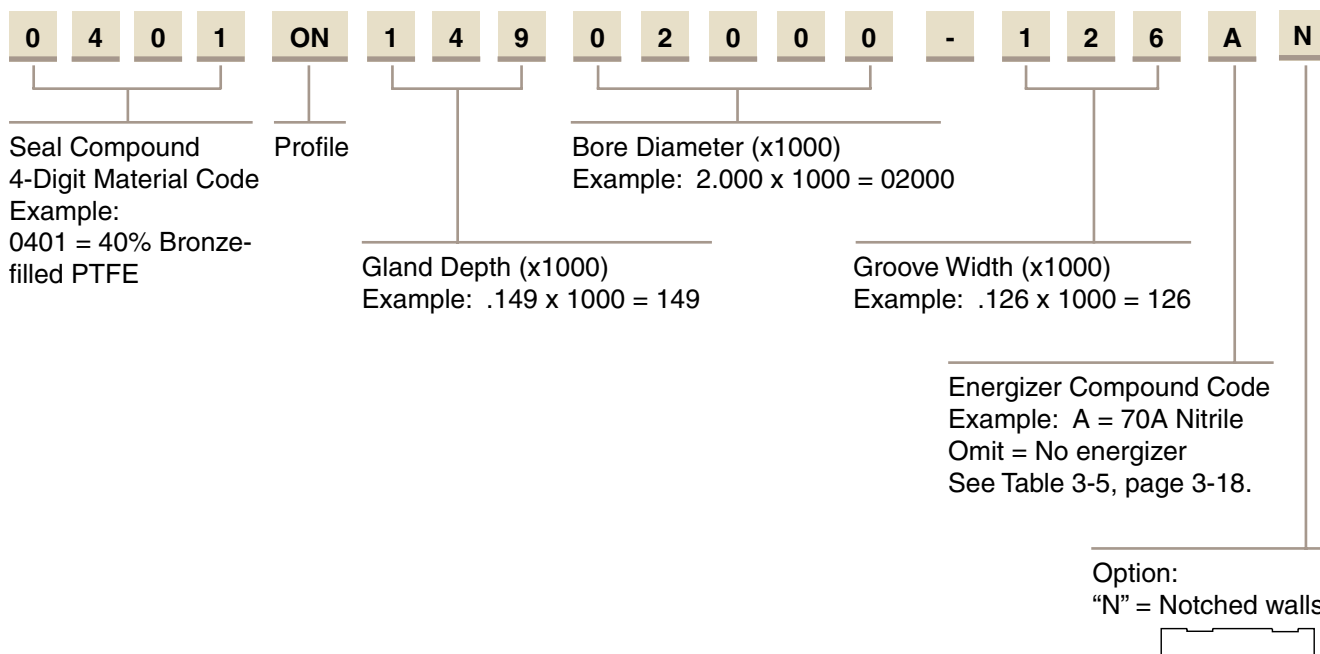

**Gland Dimensions — ON Profile**

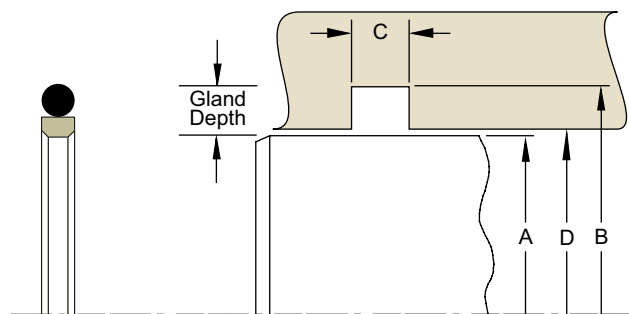

Please refer to Engineering Section 2, Page 2-8 for surface finish and additional hardware considerations.

**Table 5-23. ON Profile — Inch**

A Rod Diameter	B Groove Diameter	C Groove Width	D Throat Diameter*	O-ring Dash Number	Part Number
+ .000/- .001	+ .001/- .000	+ .005/- .000	+ .001/- .000		
0.500	0.674	0.081	0.501	015	0401ON08700500-081A
0.562	0.736	0.081	0.563	016	0401ON08700562-081A
0.625	0.799	0.081	0.626	017	0401ON08700625-081A
0.687	0.861	0.081	0.688	018	0401ON08700687-081A
0.750	0.924	0.081	0.751	019	0401ON08700750-081A
0.812	0.986	0.081	0.813	020	0401ON08700812-081A
0.875	1.049	0.081	0.876	021	0401ON08700875-081A
0.937	1.111	0.081	0.938	022	0401ON08700937-081A

\*If used with wear rings, refer to wear ring throat diameter, see Section 9. For custom groove calculations, see Appendix C.

## ON Profile

Table 5-23. ON Gland Dimensions — Inch

A Rod Diameter	B Groove Diameter	C Groove Width	D Throat Diameter*	O-ring Dash Number	Part Number
<b>+ .000/- .002</b>	<b>+ .002/- .000</b>	<b>+ .005/- .000</b>	<b>+ .002/- .000</b>		
1.000	1.298	0.126	1.001	122	0401ON14901000-126A
1.062	1.360	0.126	1.063	123	0401ON14901062-126A
1.125	1.423	0.126	1.126	124	0401ON14901125-126A
1.187	1.485	0.126	1.188	125	0401ON14901187-126A
1.250	1.548	0.126	1.251	126	0401ON14901250-126A
1.312	1.610	0.126	1.313	127	0401ON14901312-126A
1.375	1.673	0.126	1.376	128	0401ON14901375-126A
1.437	1.735	0.126	1.438	129	0401ON14901437-126A
1.500	1.798	0.126	1.501	130	0401ON14901500-126A
1.562	1.860	0.126	1.563	131	0401ON14901562-126A
1.625	1.923	0.126	1.626	132	0401ON14901625-126A
1.687	1.985	0.126	1.688	133	0401ON14901687-126A
1.750	2.048	0.126	1.751	134	0401ON14901750-126A
1.875	2.173	0.126	1.876	136	0401ON14901875-126A
<b>+ .000/- .003</b>	<b>+ .003/- .000</b>	<b>+ .005/- .000</b>	<b>+ .003/- .000</b>		
2.000	2.424	0.166	2.001	228	0401ON21202000-166A
2.125	2.549	0.166	2.126	228	0401ON21202125-166A
2.250	2.674	0.166	2.251	229	0401ON21202250-166A
2.375	2.799	0.166	2.376	230	0401ON21202375-166A
2.500	2.924	0.166	2.501	231	0401ON21202500-166A
2.625	3.049	0.166	2.626	232	0401ON21202625-166A
2.750	3.174	0.166	2.751	233	0401ON21202750-166A
2.875	3.299	0.166	2.876	234	0401ON21202875-166A
3.000	3.424	0.166	3.001	235	0401ON21203000-166A
3.125	3.549	0.166	3.126	236	0401ON21203125-166A
3.250	3.674	0.166	3.251	237	0401ON21203250-166A
3.375	3.799	0.166	3.376	238	0401ON21203375-166A
3.500	3.924	0.166	3.501	239	0401ON21203500-166A
3.625	4.049	0.166	3.626	240	0401ON21203625-166A
3.750	4.174	0.166	3.751	241	0401ON21203750-166A
3.875	4.299	0.166	3.876	242	0401ON21203875-166A
<b>+ .000/- .004</b>	<b>+ .004/- .000</b>	<b>+ .005/- .000</b>	<b>+ .004/- .000</b>		
4.000	4.616	0.247	4.002	347	0401ON30804000-247A
4.125	4.741	0.247	4.127	348	0401ON30804125-247A
4.250	4.866	0.247	4.252	349	0401ON30804250-247A
4.375	4.991	0.247	4.377	350	0401ON30804375-247A
4.500	5.116	0.247	4.502	351	0401ON30804500-247A
4.625	5.241	0.247	4.627	352	0401ON30804625-247A
4.750	5.366	0.247	4.752	353	0401ON30804750-247A
4.875	5.491	0.247	4.877	354	0401ON30804875-247A
5.000	5.616	0.247	5.002	355	0401ON30805000-247A
5.125	5.741	0.247	5.127	356	0401ON30805125-247A
5.250	5.866	0.247	5.252	357	0401ON30805250-247A
5.375	5.991	0.247	5.377	358	0401ON30805375-247A
5.500	6.116	0.247	5.502	359	0401ON30805500-247A
5.625	6.241	0.247	5.627	360	0401ON30805625-247A
5.750	6.366	0.247	5.752	361	0401ON30805750-247A
5.875	6.491	0.247	5.877	361	0401ON30805875-247A

\*If used with wear rings, refer to wear ring throat diameter, see Section 9.  
For custom groove calculations, see Appendix C.

09/01/07



Table 5-23. ON Gland Dimensions — Inch (Continued)

A Rod Diameter	B Groove Diameter	C Groove Width	D Throat Diameter*	O-ring Dash Number	Part Number
<b>+ .000/- .004</b>	<b>+ .004/- .000</b>	<b>+ .005/- .000</b>	<b>+ .004/- .000</b>		
6.000	6.616	0.247	6.002	362	0401ON30806000-247A
6.125	6.741	0.247	6.127	362	0401ON30806125-247A
6.250	6.866	0.247	6.252	363	0401ON30806250-247A
6.375	6.991	0.247	6.377	363	0401ON30806375-247A
6.500	7.116	0.247	6.502	364	0401ON30806500-247A
6.750	7.366	0.247	6.752	365	0401ON30806750-247A
7.000	7.616	0.247	7.002	366	0401ON30807000-247A
7.250	7.866	0.247	7.252	367	0401ON30807250-247A
7.500	8.116	0.247	7.502	368	0401ON30807500-247A
7.750	8.366	0.247	7.752	369	0401ON30807750-247A
<b>+ .000/- .005</b>	<b>+ .005/- .000</b>	<b>+ .005/- .000</b>	<b>+ .005/- .000</b>		
8.000	8.830	0.320	8.002	445	0401ON41508000-320A
8.250	9.080	0.320	8.252	446	0401ON41508250-320A
8.500	9.330	0.320	8.502	446	0401ON41508500-320A
9.000	9.830	0.320	9.002	447	0401ON41509000-320A
9.500	10.330	0.320	9.502	448	0401ON41509500-320A
10.000	10.830	0.320	10.002	449	0401ON41510000-320A
10.500	11.330	0.320	10.502	450	0401ON41510500-320A
11.000	11.830	0.320	11.002	451	0401ON41511000-320A
11.500	12.330	0.320	11.502	452	0401ON41511500-320A
12.000	12.830	0.320	12.002	453	0401ON41512000-320A
12.500	13.330	0.320	12.502	454	0401ON41512500-320A
13.000	13.830	0.320	13.002	455	0401ON41513000-320A
13.500	14.330	0.320	13.502	456	0401ON41513500-320A
14.000	14.830	0.320	14.002	457	0401ON41514000-320A
14.500	15.330	0.320	14.502	458	0401ON41514500-320A
15.000	15.830	0.320	15.002	459	0401ON41515000-320A
15.500	16.330	0.320	15.502	460	0401ON41515500-320A
16.000	16.830	0.320	16.002	461	0401ON41516000-320A

\*If used with wear rings, refer to wear ring throat diameter, see Section 9.

For custom groove calculations, see Appendix C.

NOTE: For sizes larger than those shown in the table, please contact your local Parker Seal representative.

# Rod Seal CR Profile

Catalog EPS 5370/USA



## CR Profile, PTFE Rod Cap Seal to Retrofit O-ring Glands

The Parker CR profile is a cap seal with anti-extrusion, low friction and low wear features. The seal is a bi-directional rod seal for use in pneumatic and low to medium duty applications. Because of its short assembly length, it requires minimal space in the rod housing. The three CR profiles will fit into standard o-ring grooves without modification. Parker's CR profiles will retrofit non-Parker seals of similar design.

- CR0 fits a standard o-ring groove
- CR1 fits an o-ring groove designed for one back-up ring
- CR2 fits an o-ring groove designed for two back-up rings

The CR profile may be ordered without the energizer by omitting the energizer code. See part number nomenclature.

5

### Technical Data

Standard Materials*	Temperature Range	Pressure Range†	Surface Speed
<b>Cap</b>			
0401 40% bronze filled PTFE	-200°F to 575°F (-129°C to 302°C)	5000 psi (344 bar)	< 13 ft/s (4 m/sec)
<b>Energizer</b>			
A 70A Nitrile	-30°F to 250°F (-34°C to 121°C)		



CR Cross-Section

**\*Alternate Materials:** For pneumatic applications, compound 0102 is recommended. For applications that may require an alternate material, please see Section 3 for alternate PTFE (Table 3-4) and energizer (Table 3-5) materials.

**†Pressure Range** without wear rings (see Table 2-4, page 2-5).

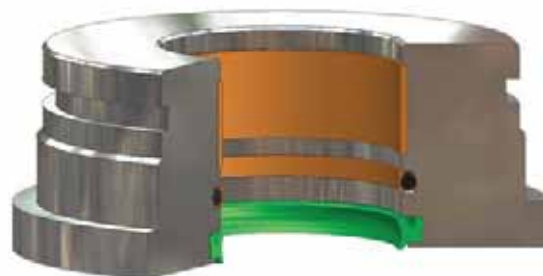

CR installed in Rod Gland

09/01/07



## Technical Data (Continued)

### Options

**Notched side walls:** Notches can be added to the side walls of the PTFE cap. This can help to optimize the seal's response to fluid pressure. Notched side walls help ensure that fluid pressure fills the cavity between the side face of the seal and the side face of the seal gland. Consult your local Parker Seal representative for the availability and cost to add side notches to the CR profile.

N = Notched walls 

## Part Number Nomenclature — CR Profile

Table 5-24. CR Profile — Inch

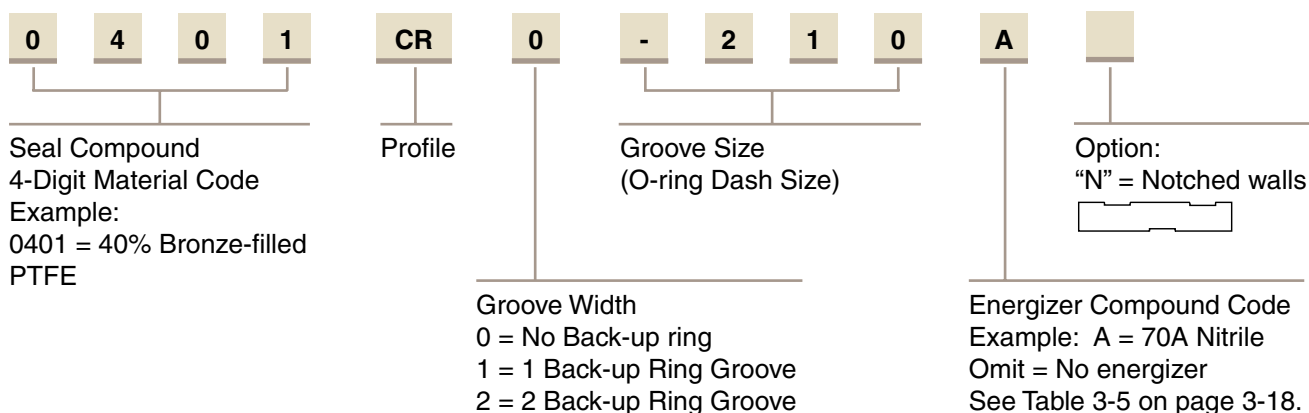

## Gland Dimensions — CR Profile

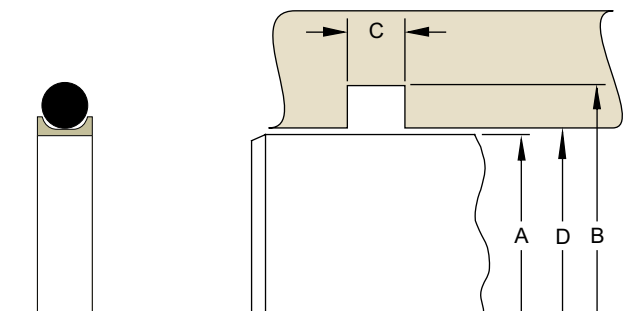

Please refer to Engineering Section 2, Page 2-8 for surface finish and additional hardware considerations.

Table 5-25. CR Profile — Inch

A Rod Diameter	B Groove Diameter	C Groove Width (CR0)	C Groove Width (CR1)	C Groove Width (CR2)	D Throat Diameter*	O-ring Dash Number	CR Part Number (X = Groove Width of 0, 1 or 2)
+ .000/- .002	+ .002/- .000	+ .005/- .000	+ .005/- .000	+ .005/- .000	+ .001/- .000		
0.125	0.235	0.093	0.138	0.205	0.126	006	0401CR X-006A
0.156	0.266	0.093	0.138	0.205	0.157	007	0401CR X-007A
0.187	0.297	0.093	0.138	0.205	0.188	008	0401CR X-008A
0.219	0.329	0.093	0.138	0.205	0.220	009	0401CR X-009A
0.250	0.360	0.093	0.138	0.205	0.251	010	0401CR X-010A
0.312	0.422	0.093	0.138	0.205	0.313	011	0401CR X-011A
0.375	0.485	0.093	0.138	0.205	0.376	012	0401CR X-012A

\*If used with wear rings, refer to wear ring throat diameter, see Section 9. For custom groove calculations, see Appendix C.

## CR Profile

Table 5-25. CR Gland Dimensions — Inch (Continued)

A Rod Diameter	B Groove Diameter	C Groove Width (CR0)	C Groove Width (CR1)	C Groove Width (CR2)	D Throat Diameter*	O-ring Dash Number	CR Part Number (X = Groove Width of 0, 1 or 2)
<b>+0.000/-0.002</b>	<b>+0.002/-0.000</b>	<b>+0.005/-0.000</b>	<b>+0.005/-0.000</b>	<b>+0.005/-0.000</b>	<b>+0.001/-0.000</b>		
0.437	0.547	0.093	0.138	0.205	0.438	013	0401CR X-013A
0.500	0.610	0.093	0.138	0.205	0.501	014	0401CR X-014A
0.562	0.672	0.093	0.138	0.205	0.563	015	0401CR X-015A
0.625	0.735	0.093	0.138	0.205	0.626	016	0401CR X-016A
0.687	0.797	0.093	0.138	0.205	0.688	017	0401CR X-017A
0.750	0.860	0.093	0.138	0.205	0.751	018	0401CR X-018A
0.812	0.922	0.093	0.138	0.205	0.813	019	0401CR X-019A
0.875	0.985	0.093	0.138	0.205	0.876	020	0401CR X-020A
0.937	1.047	0.093	0.138	0.205	0.938	021	0401CR X-021A
1.000	1.110	0.093	0.138	0.205	1.001	022	0401CR X-022A
1.062	1.172	0.093	0.138	0.205	1.063	023	0401CR X-023A
1.125	1.235	0.093	0.138	0.205	1.126	024	0401CR X-024A
1.187	1.297	0.093	0.138	0.205	1.188	025	0401CR X-025A
1.250	1.360	0.093	0.138	0.205	1.251	026	0401CR X-026A
1.312	1.422	0.093	0.138	0.205	1.313	027	0401CR X-027A
1.375	1.485	0.093	0.138	0.205	1.376	028	0401CR X-028A
<b>+0.000/-0.002</b>	<b>+0.002/-0.000</b>	<b>+0.005/-0.000</b>	<b>+0.005/-0.000</b>	<b>+0.005/-0.000</b>	<b>+0.002/-0.000</b>		
0.125	0.301	0.140	0.171	0.238	0.126	104	0401CR X-104A
0.156	0.332	0.140	0.171	0.238	0.157	105	0401CR X-105A
0.187	0.363	0.140	0.171	0.238	0.188	106	0401CR X-106A
0.218	0.394	0.140	0.171	0.238	0.219	107	0401CR X-107A
0.250	0.426	0.140	0.171	0.238	0.251	108	0401CR X-108A
0.312	0.488	0.140	0.171	0.238	0.313	109	0401CR X-109A
0.375	0.551	0.140	0.171	0.238	0.376	110	0401CR X-110A
0.437	0.613	0.140	0.171	0.238	0.438	111	0401CR X-111A
0.500	0.676	0.140	0.171	0.238	0.501	112	0401CR X-112A
0.562	0.738	0.140	0.171	0.238	0.563	113	0401CR X-113A
0.625	0.801	0.140	0.171	0.238	0.626	114	0401CR X-114A
0.687	0.863	0.140	0.171	0.238	0.688	115	0401CR X-115A
0.750	0.926	0.140	0.171	0.238	0.751	116	0401CR X-116A
0.812	0.988	0.140	0.171	0.238	0.813	117	0401CR X-117A
0.875	1.051	0.140	0.171	0.238	0.876	118	0401CR X-118A
0.937	1.113	0.140	0.171	0.238	0.938	119	0401CR X-119A
1.000	1.176	0.140	0.171	0.238	1.001	120	0401CR X-120A
1.062	1.238	0.140	0.171	0.238	1.063	121	0401CR X-121A
1.125	1.301	0.140	0.171	0.238	1.126	122	0401CR X-122A
1.187	1.363	0.140	0.171	0.238	1.188	123	0401CR X-123A
1.250	1.426	0.140	0.171	0.238	1.251	124	0401CR X-124A
1.312	1.488	0.140	0.171	0.238	1.313	125	0401CR X-125A
1.375	1.551	0.140	0.171	0.238	1.376	126	0401CR X-126A
1.437	1.613	0.140	0.171	0.238	1.439	127	0401CR X-127A
1.500	1.676	0.140	0.171	0.238	1.502	128	0401CR X-128A
1.562	1.738	0.140	0.171	0.238	1.564	129	0401CR X-129A
1.625	1.801	0.140	0.171	0.238	1.627	130	0401CR X-130A
1.687	1.863	0.140	0.171	0.238	1.689	131	0401CR X-131A
1.750	1.926	0.140	0.171	0.238	1.752	132	0401CR X-132A

\*If used with wear rings, refer to wear ring throat diameter, see Section 9.  
For custom groove calculations, see Appendix C.

09/01/07



Table 5-25. CR Gland Dimensions — Inch (Continued)

A Rod Diameter	B Groove Diameter	C Groove Width (CR0)	C Groove Width (CR1)	C Groove Width (CR2)	D Throat Diameter*	O-ring Dash Number	CR Part Number (X = Groove Width of 0, 1 or 2)
<b>+ .000/- .002</b>	<b>+ .002/- .000</b>	<b>+ .005/- .000</b>	<b>+ .005/- .000</b>	<b>+ .005/- .000</b>	<b>+ .003/- .000</b>		
1.812	1.988	0.140	0.171	0.238	1.814	133	0401CR X-133A
1.875	2.051	0.140	0.171	0.238	1.877	134	0401CR X-134A
1.937	2.113	0.140	0.171	0.238	1.939	135	0401CR X-135A
2.000	2.176	0.140	0.171	0.238	2.002	136	0401CR X-136A
2.062	2.238	0.140	0.171	0.238	2.064	137	0401CR X-137A
2.125	2.301	0.140	0.171	0.238	2.127	138	0401CR X-138A
2.187	2.363	0.140	0.171	0.238	2.189	139	0401CR X-139A
2.250	2.426	0.140	0.171	0.238	2.252	140	0401CR X-140A
2.312	2.488	0.140	0.171	0.238	2.314	141	0401CR X-141A
2.375	2.551	0.140	0.171	0.238	2.377	142	0401CR X-142A
2.437	2.613	0.140	0.171	0.238	2.439	143	0401CR X-143A
2.500	2.676	0.140	0.171	0.238	2.502	144	0401CR X-144A
2.562	2.738	0.140	0.171	0.238	2.564	145	0401CR X-145A
2.625	2.801	0.140	0.171	0.238	2.627	146	0401CR X-146A
2.687	2.863	0.140	0.171	0.238	2.689	147	0401CR X-147A
2.750	2.926	0.140	0.171	0.238	2.752	148	0401CR X-148A
2.812	2.988	0.140	0.171	0.238	2.814	149	0401CR X-149A
2.875	3.051	0.140	0.171	0.238	2.877	150	0401CR X-150A
3.000	3.176	0.140	0.171	0.238	3.002	151	0401CR X-151A
<b>+ .000/- .002</b>	<b>+ .002/- .000</b>	<b>+ .005/- .000</b>	<b>+ .005/- .000</b>	<b>+ .005/- .000</b>	<b>+ .002/- .000</b>		
0.187	0.429	0.187	0.208	0.275	0.188	201	0401CR X-201A
0.250	0.492	0.187	0.208	0.275	0.251	202	0401CR X-202A
0.312	0.554	0.187	0.208	0.275	0.313	203	0401CR X-203A
0.375	0.617	0.187	0.208	0.275	0.376	204	0401CR X-204A
0.437	0.679	0.187	0.208	0.275	0.438	205	0401CR X-205A
0.500	0.742	0.187	0.208	0.275	0.501	206	0401CR X-206A
0.562	0.804	0.187	0.208	0.275	0.563	207	0401CR X-207A
0.625	0.867	0.187	0.208	0.275	0.626	208	0401CR X-208A
0.687	0.929	0.187	0.208	0.275	0.688	209	0401CR X-209A
0.750	0.992	0.187	0.208	0.275	0.751	210	0401CR X-210A
0.812	1.054	0.187	0.208	0.275	0.813	211	0401CR X-211A
0.875	1.117	0.187	0.208	0.275	0.876	212	0401CR X-212A
0.937	1.179	0.187	0.208	0.275	0.938	213	0401CR X-213A
1.000	1.242	0.187	0.208	0.275	1.001	214	0401CR X-214A
1.062	1.304	0.187	0.208	0.275	1.063	215	0401CR X-215A
1.125	1.367	0.187	0.208	0.275	1.126	216	0401CR X-216A
1.187	1.429	0.187	0.208	0.275	1.188	217	0401CR X-217A
1.250	1.492	0.187	0.208	0.275	1.251	218	0401CR X-218A
1.312	1.554	0.187	0.208	0.275	1.313	219	0401CR X-219A
1.375	1.617	0.187	0.208	0.275	1.376	220	0401CR X-220A
1.437	1.679	0.187	0.208	0.275	1.438	221	0401CR X-221A
1.500	1.742	0.187	0.208	0.275	1.501	222	0401CR X-222A
1.625	1.867	0.187	0.208	0.275	1.627	223	0401CR X-223A
1.750	1.992	0.187	0.208	0.275	1.752	224	0401CR X-224A
1.875	2.117	0.187	0.208	0.275	1.877	225	0401CR X-225A
2.000	2.242	0.187	0.208	0.275	2.002	226	0401CR X-226A
2.125	2.367	0.187	0.208	0.275	2.127	227	0401CR X-227A

\*If used with wear rings, refer to wear ring throat diameter, see Section 9.  
For custom groove calculations, see Appendix C.

## CR Profile

Table 5-25. CR Gland Dimensions — Inch (Continued)

A Rod Diameter	B Groove Diameter	C Groove Width (CR0)	C Groove Width (CR1)	C Groove Width (CR2)	D Throat Diameter*	O-ring Dash Number	CR Part Number (X = Groove Width of 0, 1 or 2)
<b>+0.000/-0.002</b>	<b>+0.002/-0.000</b>	<b>+0.005/-0.000</b>	<b>+0.005/-0.000</b>	<b>+0.005/-0.000</b>	<b>+0.002/-0.000</b>		
2.250	2.492	0.187	0.208	0.275	2.252	228	0401CR X-228A
2.375	2.617	0.187	0.208	0.275	2.377	229	0401CR X-229A
2.500	2.742	0.187	0.208	0.275	2.502	230	0401CR X-230A
2.625	2.867	0.187	0.208	0.275	2.627	231	0401CR X-231A
2.750	2.992	0.187	0.208	0.275	2.752	232	0401CR X-232A
2.875	3.117	0.187	0.208	0.275	2.877	233	0401CR X-233A
3.000	3.242	0.187	0.208	0.275	3.002	234	0401CR X-234A
3.125	3.367	0.187	0.208	0.275	3.127	235	0401CR X-235A
3.250	3.492	0.187	0.208	0.275	3.252	236	0401CR X-236A
3.375	3.617	0.187	0.208	0.275	3.377	237	0401CR X-237A
3.500	3.742	0.187	0.208	0.275	3.502	238	0401CR X-238A
3.625	3.867	0.187	0.208	0.275	3.627	239	0401CR X-239A
3.750	3.992	0.187	0.208	0.275	3.752	240	0401CR X-240A
3.875	4.117	0.187	0.208	0.275	3.877	241	0401CR X-241A
4.000	4.242	0.187	0.208	0.275	4.002	242	0401CR X-242A
4.125	4.367	0.187	0.208	0.275	4.127	243	0401CR X-243A
4.250	4.492	0.187	0.208	0.275	4.252	244	0401CR X-244A
4.375	4.617	0.187	0.208	0.275	4.377	245	0401CR X-245A
4.500	4.742	0.187	0.208	0.275	4.503	246	0401CR X-246A
4.625	4.867	0.187	0.208	0.275	4.628	247	0401CR X-247A
4.750	4.992	0.187	0.208	0.275	4.753	248	0401CR X-248A
4.875	5.117	0.187	0.208	0.275	4.878	249	0401CR X-249A
5.000	5.242	0.187	0.208	0.275	5.003	250	0401CR X-250A
<b>+0.000/-0.002</b>	<b>+0.002/-0.000</b>	<b>+0.005/-0.000</b>	<b>+0.005/-0.000</b>	<b>+0.005/-0.000</b>	<b>+0.002/-0.000</b>		
0.437	0.807	0.281	0.311	0.410	0.439	309	0401CR X-309A
0.500	0.870	0.281	0.311	0.410	0.502	310	0401CR X-310A
0.562	0.932	0.281	0.311	0.410	0.564	311	0401CR X-311A
0.625	0.995	0.281	0.311	0.410	0.627	312	0401CR X-312A
0.687	1.057	0.281	0.311	0.410	0.689	313	0401CR X-313A
0.750	1.120	0.281	0.311	0.410	0.752	314	0401CR X-314A
0.812	1.182	0.281	0.311	0.410	0.814	315	0401CR X-315A
0.875	1.245	0.281	0.311	0.410	0.877	316	0401CR X-316A
0.937	1.307	0.281	0.311	0.410	0.939	317	0401CR X-317A
1.000	1.370	0.281	0.311	0.410	1.002	318	0401CR X-318A
1.062	1.432	0.281	0.311	0.410	1.064	319	0401CR X-319A
1.125	1.495	0.281	0.311	0.410	1.127	320	0401CR X-320A
1.187	1.557	0.281	0.311	0.410	1.189	321	0401CR X-321A
1.250	1.620	0.281	0.311	0.410	1.252	322	0401CR X-322A
1.312	1.682	0.281	0.311	0.410	1.314	323	0401CR X-323A
1.375	1.745	0.281	0.311	0.410	1.377	324	0401CR X-324A
1.500	1.870	0.281	0.311	0.410	1.502	325	0401CR X-325A
1.625	1.995	0.281	0.311	0.410	1.627	326	0401CR X-326A
1.750	2.120	0.281	0.311	0.410	1.752	327	0401CR X-327A
<b>+0.000/-0.002</b>	<b>+0.002/-0.000</b>	<b>+0.005/-0.000</b>	<b>+0.005/-0.000</b>	<b>+0.005/-0.000</b>	<b>+0.002/-0.000</b>		
1.875	2.245	0.281	0.311	0.410	1.878	328	0401CR X-328A
2.000	2.370	0.281	0.311	0.410	2.003	329	0401CR X-329A
2.125	2.495	0.281	0.311	0.410	2.128	330	0401CR X-330A
2.250	2.620	0.281	0.311	0.410	2.253	331	0401CR X-331A

\*If used with wear rings, refer to wear ring throat diameter, see Section 9.  
For custom groove calculations, see Appendix C.

09/01/07



Table 5-25. CR Gland Dimensions — Inch (Continued)

A Rod Diameter	B Groove Diameter	C Groove Width (CR0)	C Groove Width (CR1)	C Groove Width (CR2)	D Throat Diameter*	O-ring Dash Number	CR Part Number (X = Groove Width of 0, 1 or 2)
<b>+ .000/- .002</b>	<b>+ .002/- .000</b>	<b>+ .005/- .000</b>	<b>+ .005/- .000</b>	<b>+ .005/- .000</b>	<b>+ .002/- .000</b>		
2.375	2.745	0.281	0.311	0.410	2.378	332	0401CR X-332A
2.500	2.870	0.281	0.311	0.410	2.503	333	0401CR X-333A
2.625	2.995	0.281	0.311	0.410	2.628	334	0401CR X-334A
2.750	3.120	0.281	0.311	0.410	2.753	335	0401CR X-335A
2.875	3.245	0.281	0.311	0.410	2.878	336	0401CR X-336A
3.000	3.370	0.281	0.311	0.410	3.003	337	0401CR X-337A
3.125	3.495	0.281	0.311	0.410	3.128	338	0401CR X-338A
3.250	3.620	0.281	0.311	0.410	3.253	339	0401CR X-339A
3.375	3.745	0.281	0.311	0.410	3.378	340	0401CR X-340A
3.500	3.870	0.281	0.311	0.410	3.503	341	0401CR X-341A
3.625	3.995	0.281	0.311	0.410	3.628	342	0401CR X-342A
3.750	4.120	0.281	0.311	0.410	3.753	343	0401CR X-343A
3.875	4.245	0.281	0.311	0.410	3.878	344	0401CR X-344A
4.000	4.370	0.281	0.311	0.410	4.003	345	0401CR X-345A
4.125	4.495	0.281	0.311	0.410	4.128	346	0401CR X-346A
4.250	4.620	0.281	0.311	0.410	4.253	347	0401CR X-347A
4.375	4.745	0.281	0.311	0.410	4.378	348	0401CR X-348A
4.500	4.870	0.281	0.311	0.410	4.503	349	0401CR X-349A
4.625	4.995	0.281	0.311	0.410	4.628	350	0401CR X-350A
4.750	5.120	0.281	0.311	0.410	4.753	351	0401CR X-351A
4.875	5.245	0.281	0.311	0.410	4.878	352	0401CR X-352A
5.000	5.370	0.281	0.311	0.410	5.003	353	0401CR X-353A
<b>+ .000/- .002</b>	<b>+ .002/- .000</b>	<b>+ .005/- .000</b>	<b>+ .005/- .000</b>	<b>+ .005/- .000</b>	<b>+ .003/- .000</b>		
4.500	4.974	0.375	0.408	0.538	4.504	425	0401CR X-425A
4.625	5.099	0.375	0.408	0.538	4.629	426	0401CR X-426A
4.750	5.224	0.375	0.408	0.538	4.754	427	0401CR X-427A
4.875	5.349	0.375	0.408	0.538	4.879	428	0401CR X-428A
5.000	5.474	0.375	0.408	0.538	5.004	429	0401CR X-429A
5.125	5.599	0.375	0.408	0.538	5.129	430	0401CR X-430A
5.250	5.724	0.375	0.408	0.538	5.254	431	0401CR X-431A
5.375	5.849	0.375	0.408	0.538	5.379	432	0401CR X-432A
5.500	5.974	0.375	0.408	0.538	5.504	433	0401CR X-433A
5.625	6.099	0.375	0.408	0.538	5.629	434	0401CR X-434A
5.750	6.224	0.375	0.408	0.538	5.754	435	0401CR X-435A
5.875	6.349	0.375	0.408	0.538	5.879	436	0401CR X-436A
6.000	6.474	0.375	0.408	0.538	6.004	437	0401CR X-437A
6.250	6.724	0.375	0.408	0.538	6.254	438	0401CR X-438A
6.500	6.974	0.375	0.408	0.538	6.504	439	0401CR X-439A
6.750	7.224	0.375	0.408	0.538	6.754	440	0401CR X-440A
7.000	7.474	0.375	0.408	0.538	7.004	441	0401CR X-441A
7.250	7.724	0.375	0.408	0.538	7.254	442	0401CR X-442A
7.500	7.974	0.375	0.408	0.538	7.504	443	0401CR X-443A
7.750	8.224	0.375	0.408	0.538	7.754	444	0401CR X-444A
8.000	8.474	0.375	0.408	0.538	8.004	445	0401CR X-445A
8.500	8.974	0.375	0.408	0.538	8.504	446	0401CR X-446A
9.000	9.474	0.375	0.408	0.538	9.004	447	0401CR X-447A
9.500	9.974	0.375	0.408	0.538	9.504	448	0401CR X-448A
10.000	10.474	0.375	0.408	0.538	10.004	449	0401CR X-449A

\*If used with wear rings, refer to wear ring throat diameter, see Section 9.  
For custom groove calculations, see Appendix C.

09/01/07



## CR Profile

Table 5-25. CR Gland Dimensions — Inch (Continued)

A Rod Diameter	B Groove Diameter	C Groove Width (CR0)	C Groove Width (CR1)	C Groove Width (CR2)	D Throat Diameter*	O-ring Dash Number	CR Part Number (X = Groove Width of 0, 1 or 2)
<b>+0.000/-0.002</b>	<b>+0.002/-0.000</b>	<b>+0.005/-0.000</b>	<b>+0.005/-0.000</b>	<b>+0.005/-0.000</b>	<b>+0.004/-0.000</b>		
10.500	10.974	0.375	0.408	0.538	10.504	450	<b>0401CR X-450A</b>
11.000	11.474	0.375	0.408	0.538	11.004	451	<b>0401CR X-451A</b>
11.500	11.974	0.375	0.408	0.538	11.504	452	<b>0401CR X-452A</b>
12.000	12.474	0.375	0.408	0.538	12.004	453	<b>0401CR X-453A</b>
12.500	12.974	0.375	0.408	0.538	12.504	454	<b>0401CR X-454A</b>
13.000	13.474	0.375	0.408	0.538	13.004	455	<b>0401CR X-455A</b>
13.500	13.974	0.375	0.408	0.538	13.504	456	<b>0401CR X-456A</b>
14.000	14.474	0.375	0.408	0.538	14.004	457	<b>0401CR X-457A</b>
14.500	14.974	0.375	0.408	0.538	14.504	458	<b>0401CR X-458A</b>
15.000	15.474	0.375	0.408	0.538	15.004	459	<b>0401CR X-459A</b>
15.500	15.974	0.375	0.408	0.538	15.504	460	<b>0401CR X-460A</b>
16.000	16.474	0.375	0.408	0.538	16.004	461	<b>0401CR X-461A</b>

\*If used with wear rings, refer to wear ring throat diameter, see Section 9.

For custom groove calculations, see Appendix C.

NOTE: For sizes larger than those shown in the table, please contact your local Parker Seal representative.

5



# Rod Seal OC Profile

Catalog EPS 5370/USA



## OC Profile, Compact PTFE Rod Cap Seal

The Parker OC profile is a bi-directional rod seal for use in pneumatic and low to medium duty hydraulic systems. The OC profile is a two piece design utilizing a rectangular PTFE cap and standard size Parker o-ring. The OC profile is an excellent choice for applications requiring a compact design. The unique properties of the modified PTFE provide added wear resistance for improved cycle life. Parker's OC profile will retrofit non-Parker seals of similar design.

The OC profile may be ordered without the energizer by omitting the energizer code. See part number nomenclature.

### Technical Data

Standard Materials*		Temperature Range	Pressure Range†	Surface Speed
<b>Cap</b>				
0102	Modified PTFE	-320°F to 450°F (-195°C to 282°C)	1,500 psi (103 bar)	< 13 ft/s (4 m/sec)
<b>Energizer</b>				
A	70A Nitrile	-30°F to 250°F (-34°C to 121°C)		

**\*Alternate Materials:** For applications that may require an alternate material, please see Section 3 for alternate PTFE (Table 3-4) and energizer (Table 3-5) materials.

**†Pressure Range** without wear rings (see Table 2-4, page 2-5).

### Options

**Notched side walls:** Notches can be added to the side walls of the PTFE cap. This can help to optimize the seal's response to fluid pressure. Notched side walls help ensure that fluid pressure fills the cavity between the side face of the seal and the side face of the seal gland. Consult your local Parker Seal representative for the availability and cost to add side notches to the OC profile.

N= Notched walls 

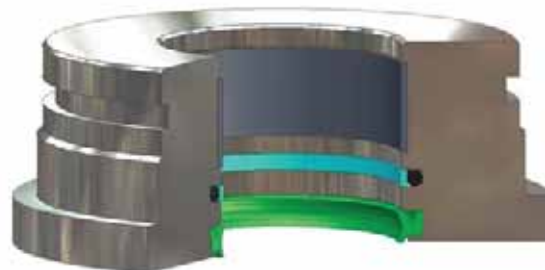

OC installed in Rod Gland

5

09/01/07

**OC Profile**

**Part Number Nomenclature — OC Profile**

**Table 5-26. OC Profile — Inch**

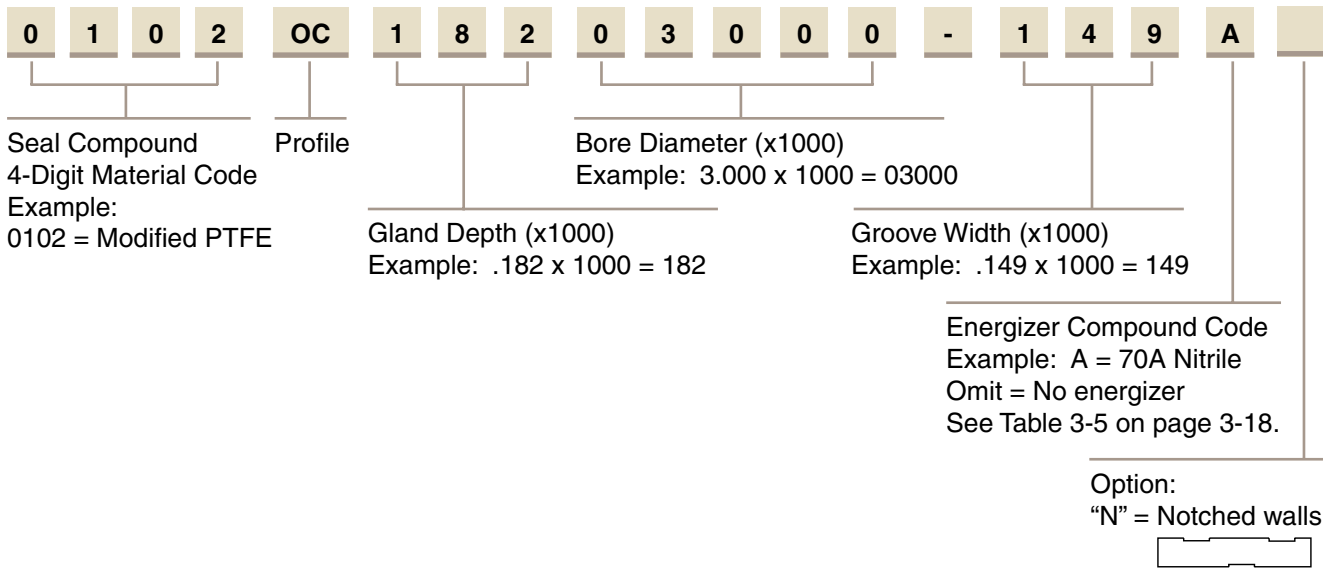

5

**Gland Dimensions — OC Profile**

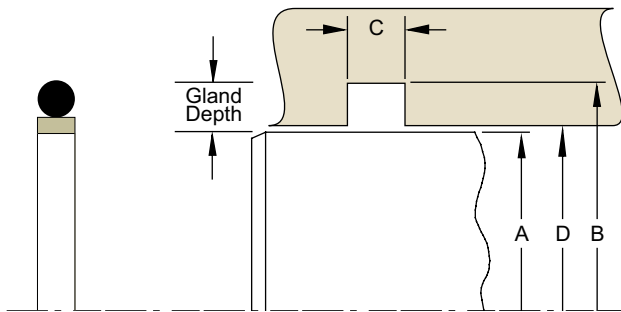

Please refer to Engineering Section 2, Page 2-8 for surface finish and additional hardware considerations.

**Table 5-27. OC Profile — Inch**

A Rod Diameter	B Groove Diameter	C Groove Width	D Throat Diameter*	O-ring Dash Number	Part Number
+0.000/-0.001	+0.001/-0.000	+0.005/-0.000	+0.002/-0.000		
0.125	0.268	0.079	0.126	007	0102OC07200125-079A
0.156	0.299	0.079	0.157	008	0102OC07200156-079A
0.187	0.331	0.079	0.188	009	0102OC07200187-079A
0.219	0.362	0.079	0.220	010	0102OC07200219-079A
0.250	0.424	0.079	0.251	011	0102OC08700250-079A
0.312	0.487	0.079	0.313	012	0102OC08700312-079A
0.375	0.547	0.079	0.376	013	0102OC08700375-079A
+0.000/-0.002	+0.002/-0.000	+0.005/-0.000	+0.002/-0.000		
0.437	0.610	0.079	0.438	014	0102OC08700437-079A
0.500	0.672	0.079	0.501	015	0102OC08700500-079A
0.562	0.735	0.079	0.563	016	0102OC08700562-079A
0.625	0.797	0.079	0.626	017	0102OC08700675-079A
0.687	0.860	0.079	0.688	018	0102OC08700687-079A

\*If used with wear rings, refer to wear ring throat diameter, see Section 9. For custom groove calculations, see Appendix C.

Table 5-27. OC Gland Dimensions — Inch (Continued)

A Rod Diameter	B Groove Diameter	C Groove Width	D Throat Diameter*	O-ring Dash Number	Part Number
<b>+ .000/- .002</b>	<b>+ .002/- .000</b>	<b>+ .005/- .000</b>	<b>+ .002/- .000</b>		
0.750	0.922	0.079	0.751	019	0102OC08700750-079A
0.812	0.985	0.079	0.813	020	0102OC08700812-079A
0.875	1.047	0.079	0.876	021	0102OC08700875-079A
0.937	1.110	0.079	0.938	022	0102OC08700937-079A
1.000	1.172	0.079	1.001	023	0102OC08701000-079A
1.062	1.235	0.079	1.063	024	0102OC08701062-079A
1.125	1.298	0.079	1.126	025	0102OC08701125-079A
1.188	1.360	0.079	1.189	026	0102OC08701188-079A
1.250	1.422	0.079	1.251	027	0102OC08701250-079A
1.312	1.485	0.079	1.313	028	0102OC08701312-079A
<b>+ .000/- .003</b>	<b>+ .003/- .000</b>	<b>+ .005/- .000</b>	<b>+ .002/- .000</b>		
0.375	0.611	0.112	0.376	111	0102OC11800375-112A
0.437	0.674	0.112	0.438	112	0102OC11800437-112A
0.500	0.736	0.112	0.501	113	0102OC11800500-112A
0.562	0.799	0.112	0.563	114	0102OC11800562-112A
0.625	0.862	0.112	0.626	115	0102OC11800625-112A
0.687	0.924	0.112	0.688	116	0102OC11800687-112A
0.750	0.986	0.112	0.751	117	0102OC11800750-112A
0.812	1.049	0.112	0.813	118	0102OC11800812-112A
0.875	1.111	0.112	0.876	119	0102OC11800875-112A
0.937	1.174	0.112	0.938	120	0102OC11800937-112A
1.000	1.236	0.112	1.001	121	0102OC11801000-112A
1.062	1.299	0.112	1.063	122	0102OC11801062-112A
1.125	1.362	0.112	1.126	123	0102OC11801125-112A
1.187	1.424	0.112	1.188	124	0102OC11801187-112A
1.250	1.486	0.112	1.251	125	0102OC11801250-112A
1.312	1.549	0.112	1.313	126	0102OC11801312-112A
1.375	1.611	0.112	1.376	127	0102OC11801375-112A
1.437	1.674	0.112	1.438	128	0102OC11801437-112A
1.500	1.736	0.112	1.501	129	0102OC11801500-112A
1.562	1.799	0.112	1.563	130	0102OC11801562-112A
1.625	1.862	0.112	1.626	131	0102OC11801625-112A
1.687	1.924	0.112	1.688	132	0102OC11801687-112A
1.750	1.986	0.112	1.751	133	0102OC11801750-112A
1.812	2.049	0.112	1.813	134	0102OC11801812-112A
1.875	2.111	0.112	1.876	135	0102OC11801875-112A
1.937	2.174	0.112	1.938	136	0102OC11801937-112A
2.000	2.236	0.112	2.001	137	0102OC11802000-112A
2.062	2.299	0.112	2.063	138	0102OC11802062-112A
2.125	2.632	0.112	2.126	139	0102OC11802125-112A
2.187	2.424	0.112	2.188	140	0102OC11802187-112A
2.250	2.486	0.112	2.251	141	0102OC11802250-112A
2.312	2.549	0.112	2.313	142	0102OC11802312-112A
2.375	2.611	0.112	2.376	143	0102OC11802375-112A
2.437	2.674	0.112	2.438	144	0102OC11802437-112A
2.500	2.736	0.112	2.501	145	0102OC11802500-112A
2.562	2.799	0.112	2.563	146	0102OC11802562-112A

\*If used with wear rings, refer to wear ring throat diameter, see Section 9.  
For custom groove calculations, see Appendix C.

**OC Profile**

**Table 5-27. OC Gland Dimensions — Inch (Continued)**

A Rod Diameter	B Groove Diameter	C Groove Width	D Throat Diameter*	O-ring Dash Number	Part Number
<b>+ .000/- .003</b>	<b>+ .003/- .000</b>	<b>+ .005/- .000</b>	<b>+ .002/- .000</b>		
2.625	2.862	0.112	2.626	147	0102OC11802625-112A
2.687	2.924	0.112	2.688	148	0102OC11802687-112A
2.750	2.986	0.112	2.751	149	0102OC11802750-112A
<b>+ .000/- .004</b>	<b>+ .004/- .000</b>	<b>+ .005/- .000</b>	<b>+ .002/- .000</b>		
0.750	1.050	0.149	0.751	211	0102OC15000750-149A
0.812	1.113	0.149	0.813	212	0102OC15000812-149A
0.875	1.175	0.149	0.876	213	0102OC15000875-149A
0.937	1.238	0.149	0.938	214	0102OC15000937-149A
1.000	1.300	0.149	1.001	215	0102OC15001000-149A
1.062	1.363	0.149	1.063	216	0102OC15001062-149A
1.125	1.426	0.149	1.126	217	0102OC15001125-149A
1.187	1.488	0.149	1.188	218	0102OC15001187-149A
1.250	1.550	0.149	1.251	219	0102OC15001250-149A
1.312	1.613	0.149	1.313	220	0102OC15001312-149A
1.375	1.675	0.149	1.376	221	0102OC15001375-149A
1.437	1.738	0.149	1.438	222	0102OC15001437-149A
1.500	1.863	0.149	1.501	223	0102OC18201500-149A
1.625	1.988	0.149	1.626	224	0102OC18201625-149A
1.750	2.113	0.149	1.751	225	0102OC18201750-149A
1.875	2.238	0.149	1.876	226	0102OC18201875-149A
2.000	2.363	0.149	2.001	227	0102OC18202000-149A
2.125	2.488	0.149	2.126	228	0102OC18202125-149A
2.250	2.613	0.149	2.251	229	0102OC18202250-149A
2.375	2.738	0.149	2.376	230	0102OC18202375-149A
2.500	2.863	0.149	2.501	231	0102OC18202500-149A
2.625	2.988	0.149	2.626	232	0102OC18202625-149A
2.750	3.113	0.149	2.751	233	0102OC18202750-149A
2.875	3.238	0.149	2.876	234	0102OC18202875-149A
3.000	3.363	0.149	3.001	235	0102OC18203000-149A
3.125	3.488	0.149	3.126	236	0102OC18203125-149A
3.250	3.613	0.149	3.251	237	0102OC18203250-149A
3.375	3.738	0.149	3.376	238	0102OC18203375-149A
3.500	3.863	0.149	3.501	239	0102OC18203500-149A
3.625	3.988	0.149	3.626	240	0102OC18203625-149A
3.750	4.113	0.149	3.751	241	0102OC18203750-149A
3.875	4.238	0.149	3.876	242	0102OC18203875-149A
4.000	4.363	0.149	4.001	243	0102OC18204000-149A
4.125	4.488	0.149	4.126	244	0102OC18204125-149A
4.250	4.613	0.149	4.251	245	0102OC18204250-149A
4.375	4.738	0.149	4.376	246	0102OC18204375-149A
4.500	4.863	0.149	4.501	247	0102OC18204500-149A
4.625	4.988	0.149	4.626	248	0102OC18204625-149A
<b>+ .000/- .005</b>	<b>+ .005/- .000</b>	<b>+ .005/- .000</b>	<b>+ .003/- .000</b>		
1.500	1.991	0.221	1.501	326	0102OC24601500-221A
1.625	2.116	0.221	1.626	327	0102OC24601625-221A
1.750	2.241	0.221	1.751	328	0102OC24601750-221A
1.875	2.366	0.221	1.876	329	0102OC24601875-221A
2.000	2.491	0.221	2.001	330	0102OC24602000-221A

\*If used with wear rings, refer to wear ring throat diameter, see Section 9.  
For custom groove calculations, see Appendix C.



Table 5-27. OC Gland Dimensions — Inch (Continued)

A Rod Diameter	B Groove Diameter	C Groove Width	D Throat Diameter*	O-ring Dash Number	Part Number
<b>+ .000/- .005</b>	<b>+ .005/- .000</b>	<b>+ .005/- .000</b>	<b>+ .003/- .000</b>		
2.125	2.616	0.221	2.126	331	0102OC24602125-221A
2.250	2.741	0.221	2.251	332	0102OC24602250-221A
2.375	2.866	0.221	2.376	333	0102OC24602375-221A
2.500	2.991	0.221	2.501	334	0102OC24602500-221A
2.625	3.116	0.221	2.626	335	0102OC24602625-221A
2.750	3.241	0.221	2.751	336	0102OC24602750-221A
2.875	3.366	0.221	2.876	337	0102OC24602875-221A
3.000	3.491	0.221	3.001	338	0102OC24603000-221A
3.125	3.616	0.221	3.126	339	0102OC24603125-221A
3.250	3.741	0.221	3.251	340	0102OC24603250-221A
3.375	3.866	0.221	3.376	341	0102OC24603375-221A
3.500	3.991	0.221	3.501	342	0102OC24603500-221A
3.625	4.116	0.221	3.626	343	0102OC24603625-221A
3.750	4.241	0.221	3.751	344	0102OC24603750-221A
3.875	4.366	0.221	3.876	345	0102OC24603875-221A
4.000	4.491	0.221	4.001	346	0102OC24604000-221A
4.125	4.616	0.221	4.126	347	0102OC24604125-221A
4.250	4.741	0.221	4.251	348	0102OC24604250-221A
4.375	4.866	0.221	4.376	349	0102OC24604375-221A
<b>+ .000/- .006</b>	<b>+ .006/- .000</b>	<b>+ .005/- .000</b>	<b>+ .004/- .000</b>		
4.500	5.093	0.297	4.502	426	0102OC29704500-297A
4.625	5.218	0.297	4.627	427	0102OC29704625-297A
4.750	5.343	0.297	4.752	428	0102OC29704750-297A
4.875	5.468	0.297	4.877	429	0102OC29704875-297A
5.000	5.593	0.297	5.002	430	0102OC29705000-297A
5.125	5.718	0.297	5.127	431	0102OC29705125-297A
5.250	5.843	0.297	5.252	432	0102OC29705250-297A
5.375	5.968	0.297	5.377	433	0102OC29705375-297A
5.500	6.093	0.297	5.502	434	0102OC29705500-297A
5.625	6.218	0.297	5.627	435	0102OC29705625-297A
5.750	6.343	0.297	5.752	436	0102OC29705750-297A
5.875	6.468	0.297	5.877	437	0102OC29705875-297A
6.000	6.718	0.297	6.002	438	0102OC35906000-297A
6.250	6.968	0.297	6.252	439	0102OC35906250-297A
6.500	7.218	0.297	6.502	440	0102OC35906500-297A
6.750	7.468	0.297	6.752	441	0102OC35906750-297A
7.000	7.718	0.297	7.002	442	0102OC35907000-297A
7.250	7.968	0.297	7.252	443	0102OC35907250-297A
7.500	8.218	0.297	7.502	444	0102OC35907500-297A
7.750	8.468	0.297	7.752	445	0102OC35907750-297A
<b>+ .000/- .006</b>	<b>+ .006/- .000</b>	<b>+ .005/- .000</b>	<b>+ .005/- .000</b>		
8.000	8.968	0.297	8.002	446	0102OC48408000-297A
8.500	9.468	0.297	8.502	447	0102OC48408500-297A
9.000	9.968	0.297	9.002	448	0102OC48409000-297A
9.500	10.468	0.297	9.502	449	0102OC48409500-297A
10.000	10.968	0.297	10.002	450	0102OC48410000-297A
10.500	11.468	0.297	10.502	451	0102OC48410500-297A
11.000	11.968	0.297	11.002	452	0102OC48411000-297A

\*If used with wear rings, refer to wear ring throat diameter, see Section 9.  
For custom groove calculations, see Appendix C.

**OC Profile****Table 5-27. OC Gland Dimensions — Inch (Continued)**

A Rod Diameter	B Groove Diameter	C Groove Width	D Throat Diameter*	O-ring Dash Number	Part Number
<b>+ .000/- .006</b>	<b>+ .006/- .000</b>	<b>+ .005/- .000</b>	<b>+ .005/- .000</b>		
11.500	12.468	0.297	11.502	453	<b>0102OC48411500-297A</b>
12.000	12.968	0.297	12.002	454	<b>0102OC48412000-297A</b>
12.500	13.468	0.297	12.502	455	<b>0102OC48412500-297A</b>
13.000	13.968	0.297	13.002	456	<b>0102OC48413000-297A</b>
13.500	14.468	0.297	13.502	457	<b>0102OC48413500-297A</b>
14.000	14.968	0.297	14.002	458	<b>0102OC48414000-297A</b>
14.500	15.468	0.297	14.502	459	<b>0102OC48414500-297A</b>
15.000	15.968	0.297	15.002	460	<b>0102OC48415000-297A</b>

\*If used with wear rings, refer to wear ring throat diameter, see Section 9.

For custom groove calculations, see Appendix C.

NOTE: For sizes larger than those shown in the table, please contact your local Parker Seal representative.



# Rod Seal BR Profile

Catalog EPS 5370/USA

## BR Profile, Premium Buffer Seal



The BR profile is a compact rod seal designed to act as a buffer seal for the primary rod seal. As a buffer seal, the BR profile provides the majority of the rod sealing performance while allowing fluid to by pass onto and energize the primary rod seal. Fluid located between the BR profile and the rod seal will relieve back into the cylinder by flowing past the BR profile's flexible static side lip and slotted pedestals. This relieving or check valve function allows the BR profile and primary rod seal to work as a sealing system without the danger of developing a pressure trap. As a sealing system, the BR profile and primary rod seal provide optimal performance in the most difficult applications.

5

## Technical Data

Standard Materials*	Temperature Range	Pressure Range†	Surface Speed
P4300A90	-65°F to 275°F (-54°C to 135°C)	5000 psi (344 bar)	< 1.6 ft/s (0.5 m/s)

\***Alternate Materials:** For applications that may require an alternate material, please contact your local Parker Seal representative.

†**Pressure Range** without wear rings (see Table 2-4, page 2-5).



*BR Cross-Section*

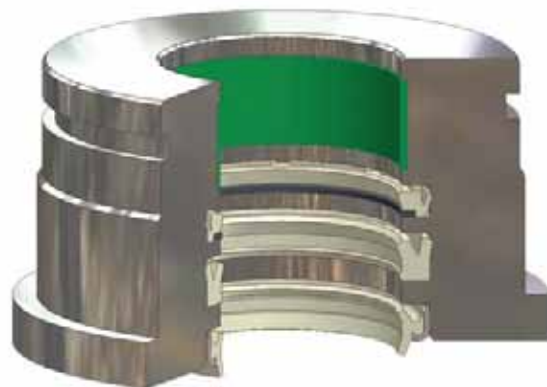

*BR Installed in Rod Gland*

09/01/07

## BR Profile

### Part Number Nomenclature — BR Profile

Table 5-28. BR Profile — Inch

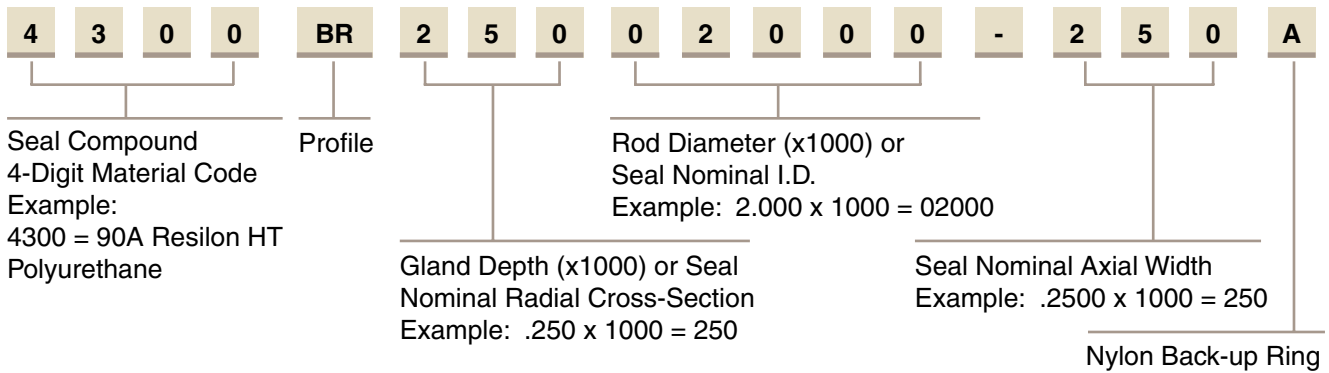

### Gland Dimensions — BR Profile

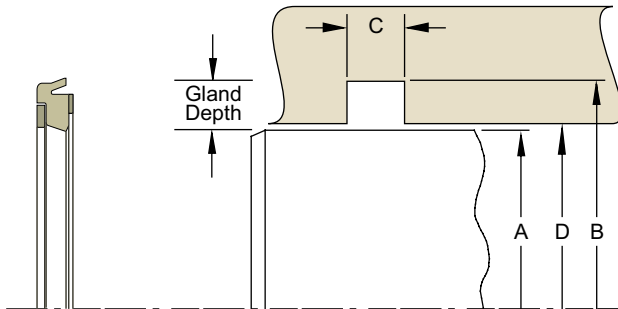

Table 5-29. Gland Dimension Tolerances

Nominal Gland Depth	A Rod Diameter	B Groove Diameter	C Groove Width	D Throat Diameter
1/8	+0.000/-0.001	+0.002/-0.000	+0.015/-0.000	+0.002/-0.000
3/16	+0.000/-0.002	+0.002/-0.000		+0.002/-0.000
1/4	+0.000/-0.002	+0.003/-0.000		+0.003/-0.000
5/16	+0.000/-0.002	+0.004/-0.000		+0.003/-0.000
3/8	+0.000/-0.002	+0.005/-0.000		+0.004/-0.000
7/16	+0.000/-0.003	+0.006/-0.000		+0.004/-0.000
1/2	+0.000/-0.003	+0.007/-0.000		+0.005/-0.000
5/8	+0.000/-0.003	+0.009/-0.000		+0.006/-0.000
3/4	+0.000/-0.004	+0.011/-0.000		+0.007/-0.000
1	+0.000/-0.005	+0.015/-0.000		+0.009/-0.000

Please refer to Engineering Section 2, Page 2-8 for surface finish and additional hardware considerations.

Table 5-30. BR Gland Dimensions — Inch

A Rod Diameter	B Groove Diameter	C Groove Width	D Throat Diameter*	Part Number	
1.000	1.374	0.205	1.001	4300	BR18701000-187A
1.125	1.499	0.205	1.126	4300	BR18701125-187A
1.250	1.624	0.205	1.251	4300	BR18701250-187A
1.250	1.812	0.205	1.251	4300	BR28101250-135
1.375	1.749	0.205	1.376	4300	BR18701375-187A
1.375	1.937	0.205	1.376	4300	BR28101375-135

\*If used with wear rings, refer to wear ring throat diameter, see Section 9.  
For custom groove calculations, see Appendix C.

Table 5-30. BR Gland Dimensions — Inch (Continued)

A Rod Diameter	B Groove Diameter	C Groove Width	D Throat Diameter*	Part Number	
1.500	2.000	0.275	1.501	4300	BR25001500-250A
1.500	2.062	0.205	1.501	4300	BR28101500-135
1.750	2.250	0.275	1.751	4300	BR25001750-250A
1.750	2.312	0.205	1.751	4300	BR28101750-135
2.000	2.500	0.275	2.001	4300	BR25002000-250A
2.000	2.562	0.205	2.001	4300	BR28102000-135
2.500	3.000	0.275	2.501	4300	BR25002500-250A
2.500	3.174	0.275	2.502	4300	BR33702500-229A
2.750	3.397	0.252	2.752	4300	BR32402750-229A
3.000	3.500	0.275	3.001	4300	BR25003000-250A
3.500	4.000	0.275	3.501	4300	BR25003500-250A
3.500	4.166	0.252	3.502	4300	BR33303500-229A
3.750	4.250	0.275	3.751	4300	BR25003750-250A
4.000	4.624	0.343	4.002	4300	BR31204000-312A
4.000	4.666	0.252	4.002	4300	BR33304000-229A
4.250	4.750	0.275	4.251	4300	BR25004250-250A
4.250	4.866	0.275	4.252	4300	BR30804250-250A
4.500	5.124	0.343	4.502	4300	BR31204500-312A
4.750	5.500	0.412	4.752	4300	BR37504750-375A
5.000	5.750	0.412	5.002	4300	BR37505000-375A
5.000	5.830	0.358	5.002	4300	BR41505000-325A
5.500	6.250	0.412	5.502	4300	BR37505500-375A
5.750	6.250	0.275	5.751	4300	BR25005750-250A
9.000	10.000	0.550	9.002	4300	BR50009000-500A

\*If used with wear rings, refer to wear ring throat diameter, see Section 9.

For custom groove calculations, see Appendix C.

NOTE: For sizes larger than those shown in the table, please contact your local Parker Seal representative.

# Rod Seal OD Profile

Catalog EPS 5370/USA

5



OD Cross-Section

## OD Profile, PTFE Buffer Seal

The Parker OD profile is a rod seal that can be used as a buffer seal in conjunction with a primary rod seal or in tandem with itself to form a sealing system for higher performance. The OD profile is a uni-directional seal, with a unique design that allows trapped fluid pressure back into the cylinder. When the rod extends from the cylinder the OD profile is riding on a sealing point, creating a high compression point to limit leakage. As the rod goes through its return stroke this seal rocks forward, creating a larger sealing surface on the rod. The compression force is spread out over a larger area allowing trapped fluid to pass under the seal and return to the system. This pressure relief feature allows the OD profile to be used in tandem or multiple seal arrangements. The OD features low friction, long life, and versatility.

The OD profile may be ordered without the energizer by omitting the energizer code. See part number nomenclature.

### Technical Data

Standard Materials* Cap	Temperature Range	Pressure Range†	Surface Speed
0401 40% bronze-filled PTFE	-200°F to 575°F (-129°C to 302°C)	5000 psi (344 bar)	< 13 ft/s (4 m/sec)
<b>Energizer</b> A	70A Nitrile	-30°F to 250°F (-34°C to 121°C)	

**\*Alternate Materials:** For applications that may require an alternate material, please see Section 3 for alternate PTFE (Table 3-4) and energizer (Table 3-5) materials.

**†Pressure Range** without wear rings (see Table 2-4, page 2-5).

### Options

**Metric:** To configure metric part numbering, see Table 5-34 on page 5-52.

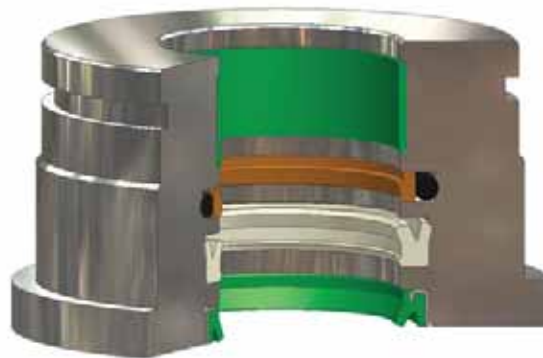

OD installed in Rod Gland

09/01/07

### Part Number Nomenclature — OD Profile

Table 5-31. OD Profile — Inch

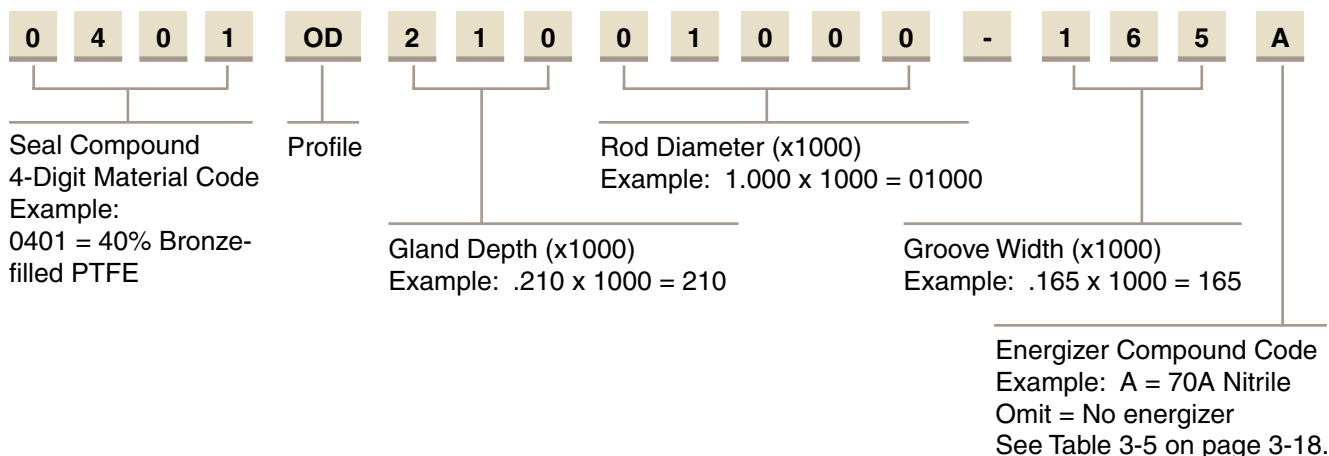

### Gland Dimensions — OD Profile

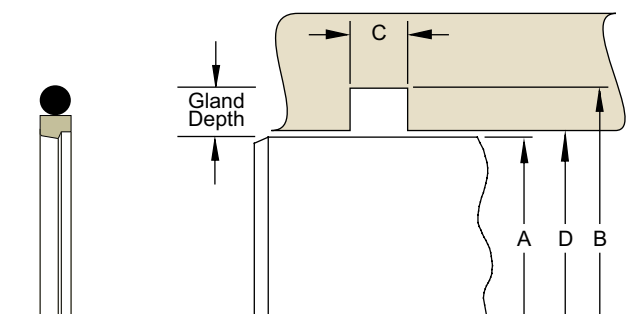

Please refer to Engineering Section 2, Page 2-8 for surface finish and additional hardware considerations.



Table 5-32. OD Profile — Inch

A Rod Diameter	B Groove Diameter	C Groove Width	D Throat Diameter*	O-ring Dash Number	Part Number
<b>+.000 / -.001</b>	<b>+.001/- .000</b>	<b>+.008/- .000</b>	<b>+.002/- .000</b>		
0.313	0.599	0.126	0.314	111	0401OD14300313-126A
0.375	0.661	0.126	0.376	112	0401OD14300375-126A
<b>+.000 / -.002</b>	<b>+.002/- .000</b>	<b>+.008/- .000</b>	<b>+.002/- .000</b>		
0.438	0.724	0.126	0.439	113	0401OD14300438-126A
0.500	0.786	0.126	0.501	114	0401OD14300500-126A
0.563	0.849	0.126	0.564	115	0401OD14300563-126A
0.625	0.911	0.126	0.626	116	0401OD14300625-126A
0.688	0.974	0.126	0.689	117	0401OD14300688-126A
<b>+.000 / -.002</b>	<b>+.002/- .000</b>	<b>+.008/- .000</b>	<b>+.002/- .000</b>		
0.750	1.170	0.165	0.751	213	0401OD21000750-165A
0.813	1.233	0.165	0.814	214	0401OD21000813-165A
0.875	1.295	0.165	0.876	215	0401OD21000875-165A
0.938	1.358	0.165	0.939	216	0401OD21000938-165A
1.000	1.420	0.165	1.001	217	0401OD21001000-165A
1.063	1.483	0.165	1.064	218	0401OD21001063-165A
1.125	1.545	0.165	1.126	219	0401OD21001125-165A
1.188	1.608	0.165	1.189	220	0401OD21001188-165A
1.250	1.670	0.165	1.251	221	0401OD21001250-165A
1.313	1.733	0.165	1.314	222	0401OD21001313-165A

\*If used with wear rings, refer to wear ring throat diameter, see Section 9.  
For custom groove calculations, see Appendix C.



**OD Profile**

**Table 5-32. OD Gland Dimensions — Inch (Continued)**

A Rod Diameter	B Groove Diameter	C Groove Width	D Throat Diameter*	O-ring Dash Number	Part Number
<b>+.000 / -.002</b>	<b>+.002/-.000</b>	<b>+.008/-.000</b>	<b>+.002/-.000</b>		
1.375	1.795	0.165	1.376	222	0401OD21001375-165A
1.438	1.858	0.165	1.439	223	0401OD21001438-165A
<b>+.000 / -.002</b>	<b>+.002/-.000</b>	<b>+.008/-.000</b>	<b>+.003/-.000</b>		
1.500	2.094	0.248	1.501	327	0401OD29701500-248A
1.563	2.157	0.248	1.564	327	0401OD29701563-248A
1.625	2.219	0.248	1.626	328	0401OD29701625-248A
1.688	2.282	0.248	1.689	328	0401OD29701688-248A
1.750	2.344	0.248	1.751	329	0401OD29701750-248A
1.813	2.407	0.248	1.814	329	0401OD29701813-248A
1.875	2.469	0.248	1.876	330	0401OD29701875-248A
1.938	2.532	0.248	1.939	330	0401OD29701938-248A
<b>+.000 / -.003</b>	<b>+.003/-.000</b>	<b>+.008/-.000</b>	<b>+.003/-.000</b>		
2.000	2.594	0.248	2.001	331	0401OD29702000-248A
2.125	2.719	0.248	2.126	332	0401OD29702125-248A
2.250	2.844	0.248	2.251	333	0401OD29702250-248A
2.375	2.969	0.248	2.376	334	0401OD29702375-248A
2.500	3.094	0.248	2.501	335	0401OD29702500-248A
2.625	3.219	0.248	2.626	336	0401OD29702625-248A
2.750	3.344	0.248	2.751	337	0401OD29702750-248A
2.875	3.469	0.248	2.876	338	0401OD29702875-248A
3.000	3.594	0.248	3.001	339	0401OD29703000-248A
3.125	3.719	0.248	3.126	340	0401OD29703125-248A
3.250	3.844	0.248	3.251	341	0401OD29703250-248A
3.375	3.969	0.248	3.376	342	0401OD29703375-248A
3.500	4.094	0.248	3.501	343	0401OD29703500-248A
3.625	4.219	0.248	3.626	344	0401OD29703625-248A
3.750	4.344	0.248	3.751	345	0401OD29703750-248A
3.875	4.469	0.248	3.876	346	0401OD29703875-248A
4.000	4.594	0.248	4.001	347	0401OD29704000-248A
4.125	4.719	0.248	4.126	348	0401OD29704125-248A
4.250	4.844	0.248	4.251	349	0401OD29704250-248A
4.375	4.969	0.248	4.376	350	0401OD29704375-248A
4.500	5.094	0.248	4.501	351	0401OD29704500-248A
4.625	5.219	0.248	4.626	352	0401OD29704625-248A
<b>+.000 / -.004</b>	<b>+.004/-.000</b>	<b>+.008/-.000</b>	<b>+.003/-.000</b>		
4.750	5.344	0.248	4.752	353	0401OD29704750-248A
4.875	5.469	0.248	4.877	354	0401OD29704875-248A
5.000	5.594	0.248	5.002	355	0401OD29705000-248A
5.125	5.719	0.248	5.127	356	0401OD29705125-248A
5.250	5.844	0.248	5.252	357	0401OD29705250-248A
5.375	5.969	0.248	5.377	358	0401OD29705375-248A
5.500	6.094	0.248	5.502	359	0401OD29705500-248A
5.625	6.219	0.248	5.627	360	0401OD29705625-248A
5.750	6.344	0.248	5.752	361	0401OD29705750-248A
6.000	6.594	0.248	6.002	362	0401OD29706000-248A
6.250	6.844	0.248	6.252	363	0401OD29706250-248A
6.500	7.094	0.248	6.502	364	0401OD29706500-248A
6.750	7.344	0.248	6.752	365	0401OD29706750-248A
7.000	7.594	0.248	7.002	366	0401OD29707000-248A

\*If used with wear rings, refer to wear ring throat diameter, see Section 9. For custom groove calculations, see Appendix C.





Table 5-32. OD Gland Dimensions — Inch (Continued)

A Rod Diameter	B Groove Diameter	C Groove Width	D Throat Diameter*	O-ring Dash Number	Part Number
<b>+.000 / -.005</b>	<b>+.005/-0.000</b>	<b>+.008/-0.000</b>	<b>+.003/-0.000</b>		
7.250	7.844	0.248	7.252	367	0401OD29707250-248A
7.500	8.094	0.248	7.502	368	0401OD29707500-248A
7.750	8.344	0.248	7.752	369	0401OD29707750-248A
<b>+.000 / -.005</b>	<b>+.005/-0.000</b>	<b>+.008/-0.000</b>	<b>+.004/-0.000</b>		
8.000	8.806	0.319	8.003	445	0401OD40308000-319A
8.250	9.056	0.319	8.253	446	0401OD40308250-319A
8.500	9.306	0.319	8.503	446	0401OD40308500-319A
8.750	9.556	0.319	8.753	447	0401OD40308750-319A
9.000	9.806	0.319	9.003	447	0401OD40309000-319A
9.250	10.056	0.319	9.253	448	0401OD40309250-319A
9.500	10.306	0.319	9.503	448	0401OD40309500-319A
9.750	10.556	0.319	9.753	449	0401OD40309750-319A
<b>+.000 / -.005</b>	<b>+.005/-0.000</b>	<b>+.008/-0.000</b>	<b>+.005/-0.000</b>		
10.000	10.944	0.319	10.003	450	0401OD47210000-319A
10.500	11.444	0.319	10.503	451	0401OD47210500-319A
11.000	11.944	0.319	11.003	452	0401OD47211000-319A
11.500	12.444	0.319	11.503	453	0401OD47211500-319A
12.000	12.944	0.319	12.003	454	0401OD47212000-319A
<b>+.000 / -.006</b>	<b>+.006/-0.000</b>	<b>+.008/-0.000</b>	<b>+.005/-0.000</b>		
12.500	13.444	0.319	12.503	454	0401OD47212500-319A
13.000	13.944	0.319	13.003	455	0401OD47213000-319A
13.500	14.444	0.319	13.503	456	0401OD47213500-319A
14.000	14.944	0.319	14.003	457	0401OD47214000-319A
14.500	15.444	0.319	14.503	458	0401OD47214500-319A
15.000	15.944	0.319	15.003	459	0401OD47215000-319A
15.500	16.444	0.319	15.503	460	0401OD47215500-319A
16.000	16.944	0.319	16.003	461	0401OD47216000-319A
16.500	17.444	0.319	16.503	462	0401OD47216500-319A
17.000	17.944	0.319	17.003	463	0401OD47217000-319A
17.500	18.444	0.319	17.503	464	0401OD47217500-319A
18.000	18.944	0.319	18.003	465	0401OD47218000-319A
18.500	19.444	0.319	18.503	466	0401OD47218500-319A
19.000	19.944	0.319	19.003	467	0401OD47219000-319A
19.500	20.444	0.319	19.503	468	0401OD47219500-319A
<b>+.000 / -.007</b>	<b>+.007/-0.000</b>	<b>+.008/-0.000</b>	<b>+.001/-0.000</b>		
20.000	20.944	0.319	20.003	469	0401OD47220000-319A

\*If used with wear rings, refer to wear ring throat diameter, see Section 9.

For custom groove calculations, see Appendix C.

NOTE: For sizes larger than those shown in the table, please contact your local Parker Seal representative.

## OD Profile

### Part Number Nomenclature — OD Profile

Table 5-33. OD Profile — Metric

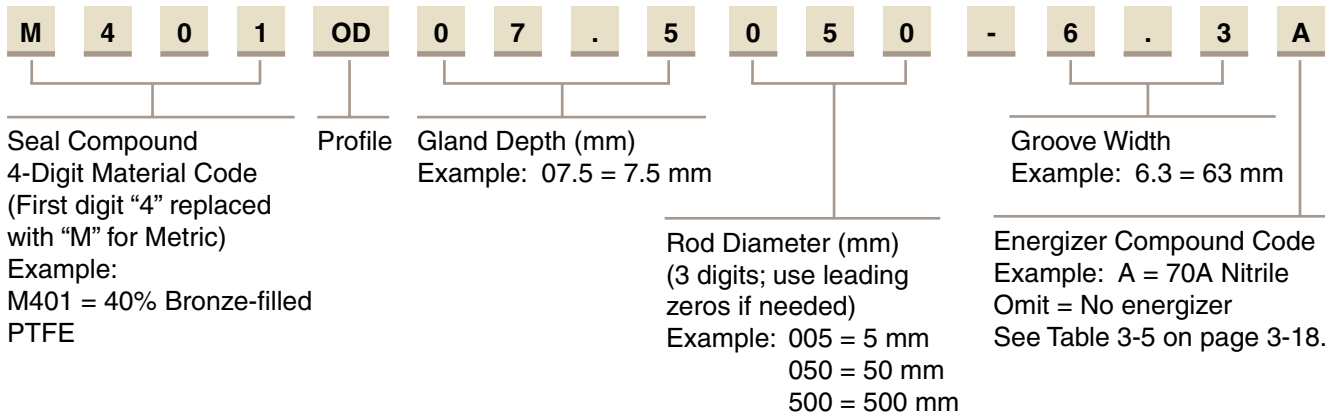

### Gland Dimensions — OD Profile

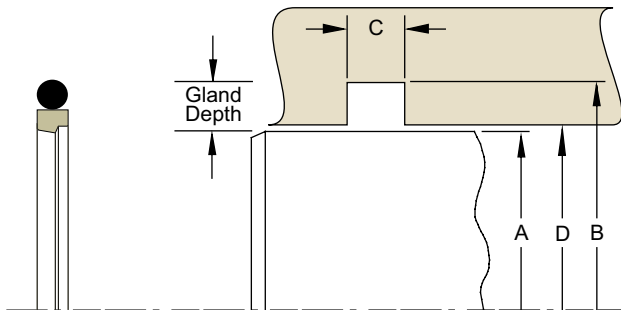

Please refer to Engineering Section 2, Page 2-8 for surface finish and additional hardware considerations.

Table 5-34. OD Profile — Metric

A Rod Diameter	B Groove Diameter	C Groove Width	D Throat Diameter*	O-ring Dash Number	Part Number
f7	H9	+ .20/- .00	H8		
For ISO tolerances refer to Appendix F.					
8.0	15.2	3.2	8.0	111	M401OD03.6008-3.2A
10.0	17.2	3.2	10.0	112	M401OD03.6010-3.2A
12.0	19.2	3.2	12.0	113	M401OD03.6012-3.2A
14.0	21.2	3.2	14.0	114	M401OD03.6014-3.2A
15.0	22.2	3.2	15.0	115	M401OD03.6015-3.2A
16.0	23.2	3.2	16.0	116	M401OD03.6016-3.2A
18.0	25.2	3.2	18.0	117	M401OD03.6018-3.2A
20.0	30.6	4.2	20.0	213	M401OD05.3020-4.2A
22.0	32.6	4.2	22.0	215	M401OD05.3022-4.2A
25.0	35.6	4.2	25.0	217	M401OD05.3025-4.2A
28.0	38.6	4.2	28.0	219	M401OD05.3028-4.2A
30.0	40.6	4.2	30.0	220	M401OD05.3030-4.2A
32.0	42.6	4.2	32.0	221	M401OD05.3032-4.2A
35.0	45.6	4.2	35.0	222	M401OD05.3035-4.2A
36.0	46.6	4.2	36.0	223	M401OD05.3036-4.2A
40.0	55.0	6.3	40.0	327	M401OD07.5040-6.3A
42.0	57.0	6.3	42.0	328	M401OD07.5042-6.3A
45.0	60.0	6.3	45.0	329	M401OD07.5045-6.3A

\*If used with wear rings, refer to wear ring throat diameter, see Section 9.  
For custom groove calculations, see Appendix C.

Table 5-34. OD Gland Dimensions — Metric (continued)

A Rod Diameter	B Groove Diameter	C Groove Width	D Throat Diameter*	O-ring Dash Number	Part Number
f7	H9	+.20/-0.00	H8		
For ISO tolerances refer to Appendix F.					
48.0	63.0	6.3	48.0	330	M401OD07.5048-6.3A
50.0	65.0	6.3	50.0	331	M401OD07.5050-6.3A
52.0	67.0	6.3	52.0	331	M401OD07.5052-6.3A
55.0	70.0	6.3	55.0	332	M401OD07.5055-6.3A
56.0	71.0	6.3	56.0	333	M401OD07.5056-6.3A
60.0	75.0	6.3	60.0	334	M401OD07.5060-6.3A
63.0	78.0	6.3	63.0	335	M401OD07.5063-6.3A
65.0	80.0	6.3	65.0	335	M401OD07.5065-6.3A
70.0	85.0	6.3	70.0	337	M401OD07.5070-6.3A
75.0	90.0	6.3	75.0	339	M401OD07.5075-6.3A
80.0	95.0	6.3	80.0	340	M401OD07.5080-6.3A
85.0	100.0	6.3	85.0	342	M401OD07.5085-6.3A
90.0	105.0	6.3	90.0	343	M401OD07.5090-6.3A
95.0	110.0	6.3	95.0	345	M401OD07.5095-6.3A
100.0	115.0	6.3	100.0	347	M401OD07.5100-6.3A
105.0	120.0	6.3	105.0	348	M401OD07.5105-6.3A
110.0	125.0	6.3	110.0	350	M401OD07.5110-6.3A
115.0	130.0	6.3	115.0	351	M401OD07.5115-6.3A
120.0	135.0	6.3	120.0	353	M401OD07.5120-6.3A
125.0	140.0	6.3	125.0	354	M401OD07.5125-6.3A
130.0	145.0	6.3	130.0	356	M401OD07.5130-6.3A
135.0	150.0	6.3	135.0	358	M401OD07.5135-6.3A
140.0	155.0	6.3	140.0	359	M401OD07.5140-6.3A
150.0	165.0	6.3	150.0	362	M401OD07.5150-6.3A
160.0	175.0	6.3	160.0	363	M401OD07.5160-6.3A
170.0	185.0	6.3	170.0	365	M401OD07.5170-6.3A
180.0	195.0	6.3	180.0	366	M401OD07.5180-6.3A
190.0	205.0	6.3	190.0	368	M401OD07.5190-6.3A
200.0	220.6	8.1	200.0	446	M401OD10.3200-8.1A
210.0	230.6	8.1	210.0	446	M401OD10.3210-8.1A
220.0	240.6	8.1	220.0	447	M401OD10.3220-8.1A
230.0	250.6	8.1	230.0	448	M401OD10.3230-8.1A
240.0	260.6	8.1	240.0	449	M401OD10.3240-8.1A
250.0	270.6	8.1	250.0	450	M401OD10.3250-8.1A
260.0	280.6	8.1	260.0	450	M401OD10.3260-8.1A
270.0	294.2	8.1	270.0	452	M401OD12.1270-8.1A
280.0	304.2	8.1	280.0	453	M401OD12.1280-8.1A
290.0	314.2	8.1	290.0	454	M401OD12.1290-8.1A
300.0	324.2	8.1	300.0	455	M401OD12.1300-8.1A
320.0	344.2	8.1	320.0	458	M401OD12.1320-8.1A
350.0	374.2	8.1	350.0	458	M401OD12.1350-8.1A
360.0	384.2	8.1	360.0	462	M401OD12.1360-8.1A
400.0	424.2	8.1	400.0	367	M401OD12.1400-8.1A
420.0	444.2	8.1	420.0	463	M401OD12.1420-8.1A
450.0	474.2	8.1	450.0	466	M401OD12.1450-8.1A
460.0	484.2	8.1	460.0	468	M401OD12.1460-8.1A
480.0	504.2	8.1	480.0	469	M401OD12.1480-8.1A
500.0	524.2	8.1	500.0	469	M401OD12.1500-8.1A

\*If used with wear rings, refer to wear ring throat diameter, see Section 9.

For custom groove calculations, see Appendix C.

NOTE: For sizes larger than those shown in the table, please contact your local Parker Seal representative.

09/01/07



# Rod Seal V6 Profile

Catalog EPS 5370/USA

## V6 Profile, Cushion Seal

The V6 profile provides a check valve type action for use in cushioning pneumatic cylinders. The V6 profile seals against the cushioning piston or spud, allowing pneumatic pressure to build and cushion the cylinder's end stroke. Through a series of slots and pedestals the intake flow is then able to easily blow past the cushion seal to fill the cylinder. The installation of the cushion seal is very simple as it manually snaps into the groove recess. The V6 profile is available in proprietary Parker compounds formulated for low friction, extrusion resistance, and high temperature. The V6 profile can be used in a wide variety of NFPA cylinders and will provide excellent performance and long life.



5

## Technical Data

Standard Materials*	Temperature Range	Pressure Range†	Surface Speed
P4622A90	-65°F to 225°F (-54°C to 107°C)	250 psi (17 bar)	< 3 ft/s (1 m/s)
N4180A80	-40°F to 250°F (-40°C to 121°C)	250 psi (17 bar)	< 3 ft/s (1 m/s)
N4181A80	-40°F to 250°F (-40°C to 121°C)	250 psi (17 bar)	< 3 ft/s (1 m/s)
V4208A90	-5°F to 400°F (-21°C to 204°C)	250 psi (17 bar)	< 3 ft/s (1 m/s)

**\*Alternate Materials:** For applications that may require an alternate material, please contact your local Parker Seal representative.

**†Pressure Range** without wear rings (see Table 2-4, page 2-5).

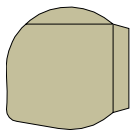

V6 Cross-Section

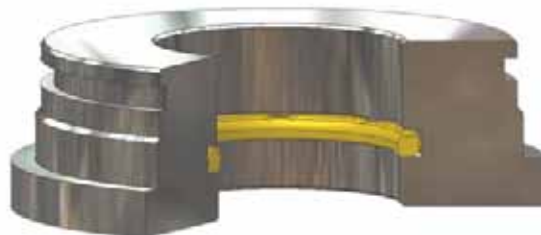

V6 Installed in Rod Gland

09/01/07

### Part Number Nomenclature — V6 Profile

Table 5-35. V6 Profile — Inch

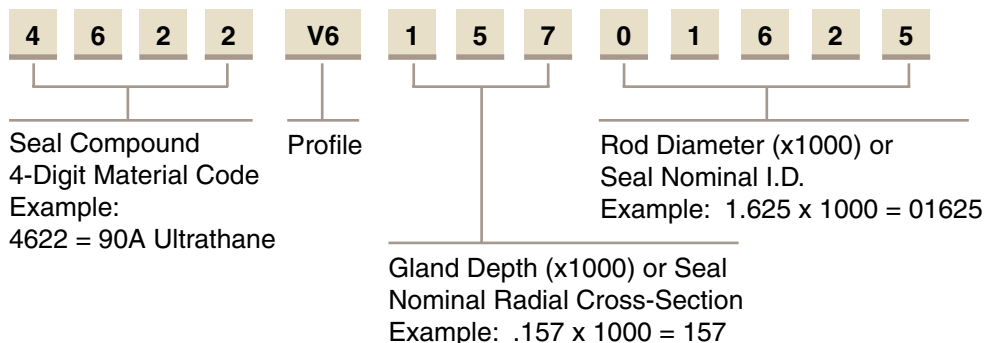

### Gland Dimensions — V6 Profile

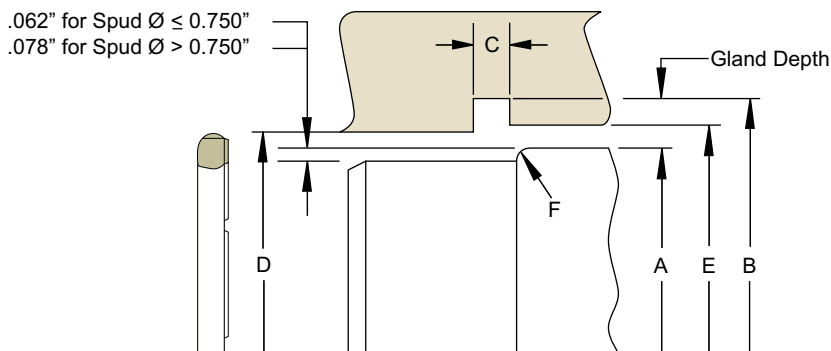

Please refer to Engineering Section 2, page 2-8 for surface finish and additional hardware considerations.



Table 5-36. V6 Gland Dimensions — Inch

Nominal Spud Diameter	A Spud Diameter	B Groove Diameter	C Groove Width	D Throat Diameter	E Throat Diameter	F Spud End Radius	Compound Codes (X = Standard Offering)			Part Number	
							4622	4180	4208	Compound Code	
3/8	0.368/0.370	0.685/0.689	0.181/0.197	0.390/0.393	0.449/0.453	0.118	X	X	X	XXXX	V615700375
5/8	0.617/0.620	0.935/0.940	0.181/0.197	0.640/0.644	0.699/0.703	0.118	X	X	X	XXXX	V615700625
3/4	0.742/0.745	1.060/1.065	0.181/0.197	0.765/0.769	0.824/0.828	0.118	X	X	X	XXXX	V615700750
7/8	0.877/0.880	1.195/1.201	0.181/0.197	0.900/0.905	0.959/0.964	0.118	X	X	X	XXXX	V615700875
1-3/16	1.179/1.184	1.578/1.585	0.228/0.244	1.208/1.215	1.263/1.270	0.157	X			XXXX	V619701187
1-1/4	1.249/1.253	1.568/1.574	0.181/0.197	1.273/1.279	1.332/1.338	0.118	X	X	X	XXXX	V615701250
1-5/8	1.620/1.624	1.939/1.945	0.181/0.197	1.644/1.650	1.703/1.709	0.118	X	X	X	XXXX	V615701625
1-5/8	1.616/1.622	2.016/2.023	0.228/0.244	1.646/1.653	1.701/1.709	0.157	X		X	XXXX	V619701625
2	1.992/1.997	2.391/2.398	0.228/0.244	2.021/2.028	2.076/2.083	0.157	X	X	X	XXXX	V619702000
2-1/4	2.242/2.247	2.562/2.569	0.181/0.197	2.267/2.274	2.326/2.333	0.118	X		X	XXXX	V615702250
2-3/4	2.735/2.740	3.291/3.300	0.323/0.339	2.764/2.771	2.858/2.865	0.197	X		X	XXXX	V627602750
4-1/4	4.219/4.225	4.776/4.786	0.323/0.339	4.249/4.258	4.343/4.352	0.197	X			XXXX	V627604250

NOTE: For sizes larger than those shown in the table, please contact your local Parker Seal representative.

## V6 Profile

### Part Number Nomenclature — V6 Profile

Table 5-37. V6 Profile — Metric

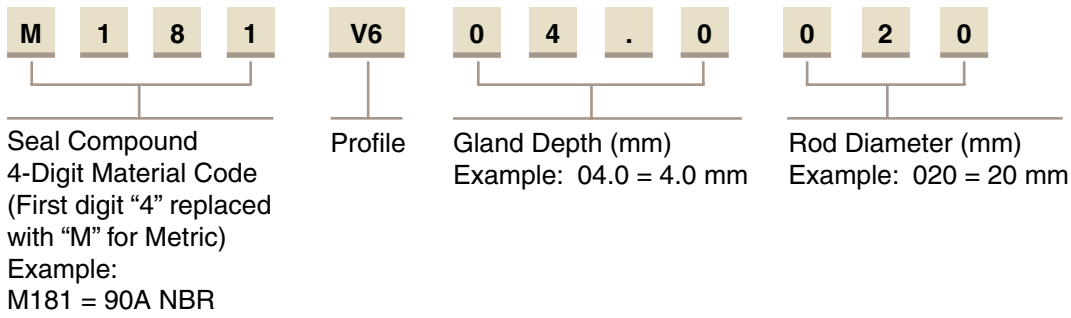

### Gland Dimensions — V6 Profile

1.5mm for Spud  $\varnothing \leq 20\text{mm}$   
2.0mm for Spud  $\varnothing > 20\text{mm}$

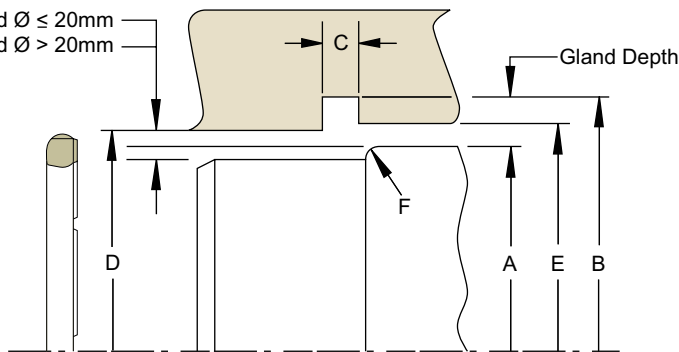

Please refer to Engineering Section 2, page 2-8 for surface finish and additional hardware considerations.

Table 5-38. V6 Gland Dimensions — Metric

Nominal Spud Diameter	A Spud Diameter	B Groove Diameter	C Groove Width	D Throat Diameter	E Throat Diameter	F Spud End Radius	Compound Codes (X = Standard Offering)		Part Number	
							M181	M208	Compound Code	
	h10	H11	+ .20/- .00	H11	H11					
For ISO tolerances refer to Appendix F.										
10.0	10.0	18.0	4,8	10.5	12.0	3.0	X	X	XXXX	V604.0010
14.0	14.0	22.0	4,8	14.5	16.0	3.0	X	X	XXXX	V604.0014
16.0	16.0	24.0	4,8	16.5	18.0	3.0	X		XXXX	V604.0016
20.0	20.0	28.0	4,8	20.5	22.0	3.0	X	X	XXXX	V604.0020
22.0	22.0	30.0	4,8	22.5	24.0	3.0	X		XXXX	V604.0022
30.0	30.0	40.0	6.0	30.6	32.0	4.0	X	X	XXXX	V605.0030
32.0	32.0	42.0	6.0	32.6	34.0	4.0	X	X	XXXX	V605.0032
38.0	38.0	48.0	6.0	38.6	40.0	4.0	X	X	XXXX	V605.0038
50.0	50.0	60.0	6.0	50.6	52.0	4.0	X	X	XXXX	V605.0050

NOTE: For sizes larger than those shown in the table, please contact your local Parker Seal representative.



# Rod Seal OR Profile

Catalog EPS 5370/USA



## OR Profile, Rotary PTFE Cap Seal

The Parker OR profile is a bi-directional rod seal for use in pneumatic and low to medium duty rotary or oscillating applications. The OR profile is a two piece design comprised of a standard size o-ring energizing a wear resistant PTFE cap. The OR profile offers long wear and low friction without stick-slip. This PTFE outer diameter is designed with a special interference with the o-ring to eliminate spinning between the o-ring and seal. Special grooves are designed into the PTFE inner diameter to provide lubrication and create a labyrinth effect for reduced leakage. The seal is commonly used in swivel joints, hose reels, and machine applications. Parker's OR profile will retrofit non-Parker seals of similar design.

The OR profile may be ordered without the energizer by omitting the energizer code. See part number nomenclature.

5

### Technical Data

Standard Materials*	Temperature Range	Pressure Range†	Surface Speed
<b>Cap</b>			
0205 15% fiberglass-, 5% MoS <sub>2</sub> -filled PTFE	-200°F to 575°F (-129°C to 302°C)	3000 psi (206 bar)	< 3.3 ft/s (1.0 m/sec)

### Energizer

A	70A Nitrile	-30°F to 250°F (-34°C to 121°C)
---	-------------	------------------------------------

**\*Alternate Materials:** For applications that may require an alternate material, please see Section 3 for alternate PTFE (Table 3-4) and energizer (Table 3-5) materials.

**†Pressure Range** without wear rings (see Table 2-4, page 2-5).

**Minimum rotary shaft hardness = 60 Rc.**

**Note:** Small size cross sections feature single outer diameter grooves. Cross sections 305 and greater feature dual grooves.

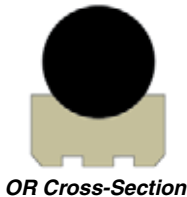

OR Cross-Section

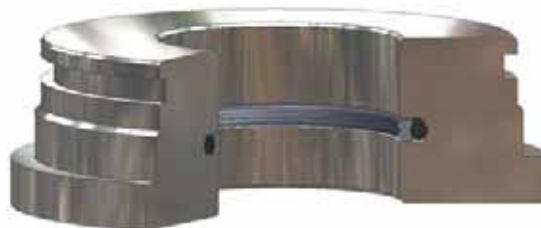

OR installed on Rotary Shaft Gland

09/01/07

**OR Profile**

**Part Number Nomenclature — OR Profile**

**Table 5-39. OR Profile — Inch**

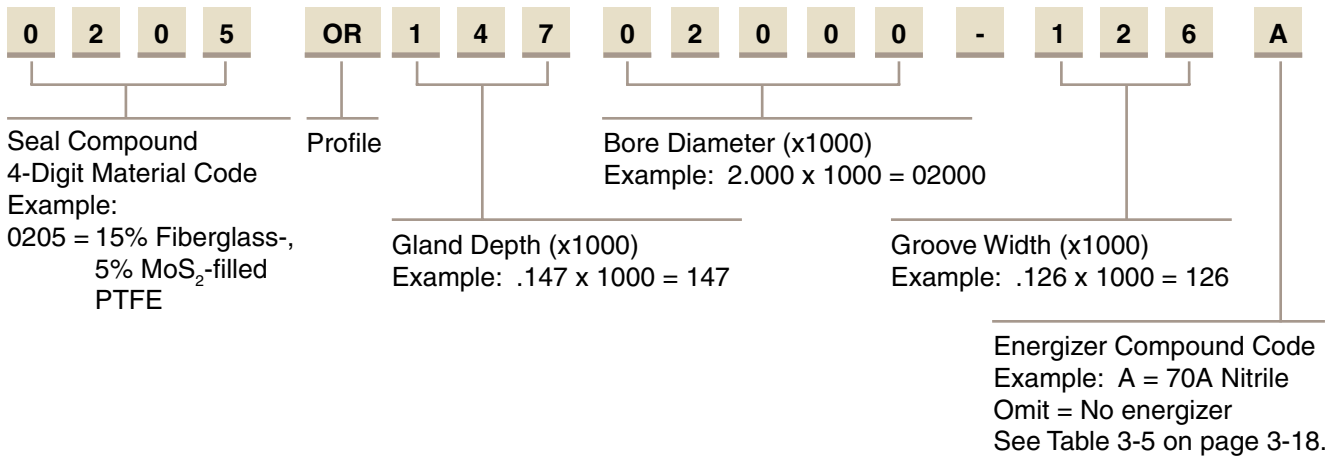

**Gland Dimensions — OR Profile**

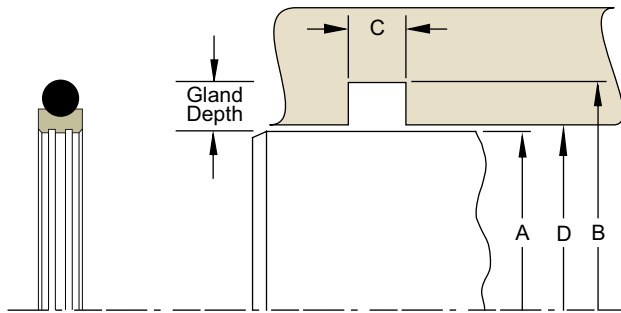

Please refer to Engineering Section 2, Page 2-8 for surface finish and additional hardware considerations.

**Table 5-40. OR Gland Dimensions — Inch**

A Rod Diameter	B Groove Diameter	C Groove Width	D Throat Diameter*	O-ring Dash Number	Part Number
<b>+ .000/- .001</b>	<b>+ .001/- .000</b>	<b>+ .008/- .000</b>	<b>+ .002/- .000</b>		
0.313	0.506	0.087	0.314	012	<b>0205OR09700313-087A</b>
0.375	0.568	0.087	0.376	013	<b>0205OR09700375-087A</b>
<b>+ .000/- .002</b>	<b>+ .002/- .000</b>	<b>+ .008/- .000</b>	<b>+ .002/- .000</b>		
0.438	0.631	0.087	0.439	014	<b>0205OR09700438-087A</b>
0.500	0.693	0.087	0.501	015	<b>0205OR09700500-087A</b>
0.563	0.756	0.087	0.564	016	<b>0205OR09700563-087A</b>
0.625	0.818	0.087	0.626	017	<b>0205OR09700625-087A</b>
0.688	0.881	0.087	0.689	018	<b>0205OR09700688-087A</b>
0.750	0.943	0.087	0.751	019	<b>0205OR09700750-087A</b>
0.813	1.006	0.087	0.814	020	<b>0205OR09700813-087A</b>
0.875	1.068	0.087	0.876	021	<b>0205OR09700875-087A</b>
0.938	1.131	0.087	0.939	022	<b>0205OR09700938-087A</b>
1.000	1.193	0.087	1.001	023	<b>0205OR09701000-087A</b>
1.125	1.318	0.087	1.126	025	<b>0205OR09701125-087A</b>
1.250	1.443	0.087	1.251	027	<b>0205OR09701250-087A</b>
1.375	1.568	0.087	1.376	028	<b>0205OR09701375-087A</b>

\*If used with wear rings, refer to wear ring throat diameter, see Section 9. For custom groove calculations, see Appendix C.

Table 5-40. OR Gland Dimensions — Inch (Continued)

A Rod Diameter	B Groove Diameter	C Groove Width	D Throat Diameter*	O-ring Dash Number	Part Number
<b>+ .000/- .002</b>	<b>+ .003/- .000</b>	<b>+ .008/- .000</b>	<b>+ .002/- .000</b>		
1.500	1.795	0.126	1.501	130	0205OR14801500-126A
1.625	1.920	0.126	1.626	132	0205OR14801625-126A
1.750	2.045	0.126	1.751	134	0205OR14801750-126A
1.875	2.170	0.126	1.876	135	0205OR14801875-126A
<b>+ .000/- .003</b>	<b>+ .003/- .000</b>	<b>+ .008/- .000</b>	<b>+ .002/- .000</b>		
2.000	2.295	0.126	2.001	137	0205OR14802000-126A
2.125	2.420	0.126	2.126	139	0205OR14802125-126A
2.250	2.545	0.126	2.251	141	0205OR14802250-126A
2.375	2.670	0.126	2.376	143	0205OR14802375-126A
2.500	2.795	0.126	2.501	145	0205OR14802500-126A
2.625	2.920	0.126	2.626	147	0205OR14802625-126A
2.750	3.045	0.126	2.751	149	0205OR14802750-126A
2.875	3.170	0.126	2.876	150	0205OR14802875-126A
<b>+ .000/- .003</b>	<b>+ .003/- .000</b>	<b>+ .008/- .000</b>	<b>+ .003/- .000</b>		
3.000	3.433	0.165	3.001	235	0205OR21703000-165A
3.125	3.558	0.165	3.126	236	0205OR21703125-165A
3.250	3.683	0.165	3.251	237	0205OR21703250-165A
3.375	3.808	0.165	3.376	238	0205OR21703375-165A
3.500	3.933	0.165	3.501	239	0205OR21703500-165A
3.625	4.058	0.165	3.626	240	0205OR21703625-165A
3.750	4.183	0.165	3.751	241	0205OR21703750-165A
3.875	4.308	0.165	3.876	242	0205OR21703875-165A
4.000	4.433	0.165	4.001	243	0205OR21704000-165A
4.125	4.558	0.165	4.126	244	0205OR21704125-165A
4.250	4.683	0.165	4.251	245	0205OR21704250-165A
<b>+ .000/- .003</b>	<b>+ .004/- .000</b>	<b>+ .008/- .000</b>	<b>+ .003/- .000</b>		
4.375	4.808	0.165	4.376	246	0205OR21704375-165A
4.500	4.933	0.165	4.501	247	0205OR21704500-165A
4.625	5.058	0.165	4.626	248	0205OR21704625-165A
<b>+ .000/- .004</b>	<b>+ .004/- .000</b>	<b>+ .008/- .000</b>	<b>+ .003/- .000</b>		
4.750	5.183	0.165	4.751	249	0205OR21704750-165A
4.875	5.308	0.165	4.876	250	0205OR21704875-165A
5.000	5.433	0.165	5.001	251	0205OR21705000-165A
5.125	5.558	0.165	5.126	252	0205OR21705125-165A
5.250	5.683	0.165	5.251	253	0205OR21705250-165A
5.375	5.808	0.165	5.376	254	0205OR21705375-165A
5.500	5.933	0.165	5.501	255	0205OR21705500-165A
5.625	6.058	0.165	5.626	256	0205OR21705625-165A
5.750	6.183	0.165	5.751	257	0205OR21705750-165A
5.875	6.308	0.165	5.876	258	0205OR21705875-165A
<b>+ .000/- .004</b>	<b>+ .004/- .000</b>	<b>+ .008/- .000</b>	<b>+ .004/- .000</b>		
6.000	6.610	0.248	6.002	362	0205OR30506000-248A
6.250	6.860	0.248	6.252	363	0205OR30506250-248A
6.500	7.110	0.248	6.502	364	0205OR30506500-248A
6.750	7.360	0.248	6.752	365	0205OR30506750-248A
7.000	7.610	0.248	7.002	365	0205OR30507000-248A

\*If used with wear rings, refer to wear ring throat diameter, see Section 9.  
For custom groove calculations, see Appendix C.

## OR Profile

Table 5-40. OR Gland Dimensions — Inch (Continued)

A Rod Diameter	B Groove Diameter	C Groove Width	D Throat Diameter*	O-ring Dash Number	Part Number
<b>+.000/-0.005</b>	<b>+.005/-0.000</b>	<b>+.008/-0.000</b>	<b>+.004/-0.000</b>		
7.250	7.860	0.248	7.252	366	0205OR30507250-248A
7.500	8.110	0.248	7.502	367	0205OR30507500-248A
7.750	8.360	0.248	7.752	368	0205OR30507750-248A
8.000	8.610	0.248	8.002	369	0205OR30508000-248A
8.250	8.860	0.248	8.252	370	0205OR30508250-248A
8.500	9.110	0.248	8.502	371	0205OR30508500-248A
8.750	9.360	0.248	8.752	372	0205OR30508750-248A
9.000	9.610	0.248	9.002	373	0205OR30509000-248A
9.250	9.860	0.248	9.252	374	0205OR30509250-248A
9.500	10.110	0.248	9.502	375	0205OR30509500-248A
9.750	10.360	0.248	9.752	376	0205OR30509750-248A
10.000	10.610	0.248	10.002	377	0205OR30510000-248A
10.500	11.110	0.248	10.502	378	0205OR30510500-248A
11.000	11.610	0.248	11.002	379	0205OR30511000-248A
11.500	12.110	0.248	11.502	380	0205OR30511500-248A
<b>+.000/-0.006</b>	<b>+.006/-0.000</b>	<b>+.008/-0.000</b>	<b>+.005/-0.000</b>		
12.000	12.827	0.319	12.002	453	0205OR41412000-319A
12.500	13.327	0.319	12.502	454	0205OR41412500-319A
13.000	13.827	0.319	13.002	455	0205OR41413000-319A
13.500	14.327	0.319	13.502	456	0205OR41413500-319A
14.000	14.827	0.319	14.002	457	0205OR41414000-319A
14.500	15.327	0.319	14.502	458	0205OR41414500-319A
15.000	15.827	0.319	15.002	459	0205OR41415000-319A
15.500	16.327	0.319	15.502	460	0205OR41415500-319A
16.000	16.827	0.319	16.002	461	0205OR41416000-319A
16.500	17.327	0.319	16.502	462	0205OR41416500-319A
17.000	17.827	0.319	17.002	463	0205OR41417000-319A
17.500	18.327	0.319	17.502	464	0205OR41417500-319A
18.000	18.827	0.319	18.002	465	0205OR41418000-319A
18.500	19.327	0.319	18.502	466	0205OR41418500-319A
19.000	19.827	0.319	19.002	467	0205OR41419000-319A
19.500	20.327	0.319	19.502	468	0205OR41419500-319A
<b>+.000/-0.007</b>	<b>+.007/-0.000</b>	<b>+.008/-0.000</b>	<b>+.005/-0.000</b>		
20.000	20.827	0.319	20.002	469	0205OR41420000-319A

\*If used with wear rings, refer to wear ring throat diameter, see Section 9.

For custom groove calculations, see Appendix C.

NOTE: For sizes larger than those shown in the table, please contact your local Parker Seal representative.

### Part Number Nomenclature — OR Profile

Table 5-41. OR Profile — Metric

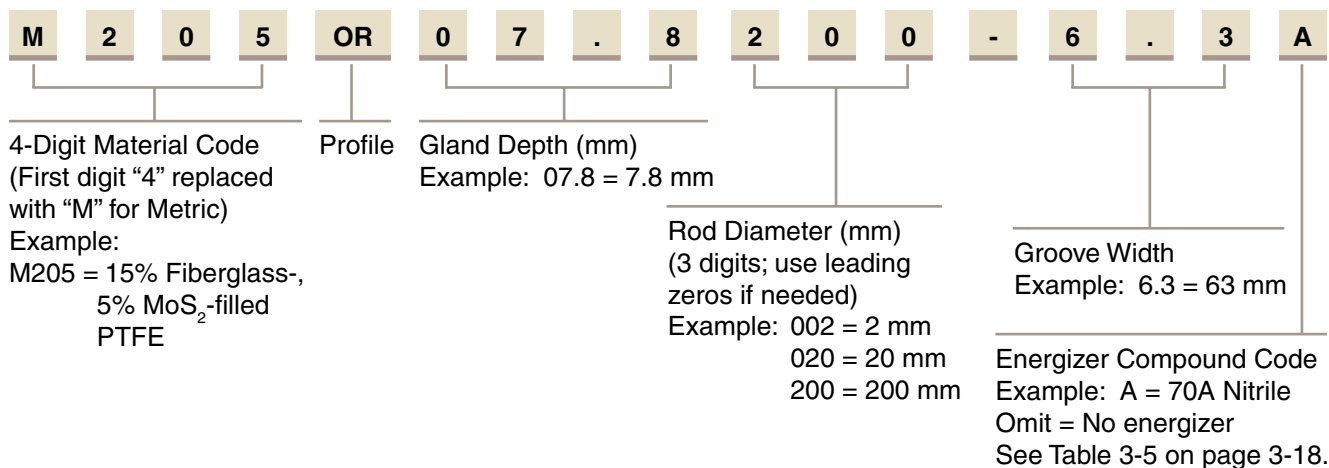

### Gland Dimensions — OR Profile

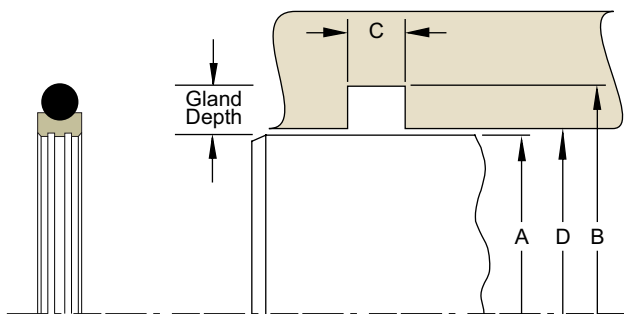

Please refer to Engineering Section 2, Page 2-8 for surface finish and additional hardware considerations.



Table 5-42. OR Gland Dimensions — Metric

A Rod Diameter	B Groove Diameter	C Groove Width	D Throat Diameter*	O-ring Dash Number	Part Number
f7	H9	+ .20/- .00	H8		
For ISO tolerances refer to Appendix F.					
6.0	10.9	2.2	6.0	011	M205OR02.5006-2.2A
8.0	12.9	2.2	8.0	012	M205OR02.5008-2.2A
10.0	14.9	2.2	10.0	013	M205OR02.5010-2.2A
12.0	16.9	2.2	12.0	014	M205OR02.5012-2.2A
14.0	18.9	2.2	14.0	016	M205OR02.5014-2.2A
15.0	19.9	2.2	15.0	016	M205OR02.5015-2.2A
16.0	20.9	2.2	16.0	017	M205OR02.5016-2.2A
18.0	22.9	2.2	18.0	018	M205OR02.5018-2.2A
20.0	27.5	3.2	20.0	118	M205OR03.8020-3.2A
22.0	29.5	3.2	22.0	119	M205OR03.8022-3.2A
25.0	32.5	3.2	25.0	121	M205OR03.8025-3.2A
28.0	35.5	3.2	28.0	123	M205OR03.8028-3.2A
30.0	37.5	3.2	30.0	124	M205OR03.8030-3.2A
32.0	39.5	3.2	32.0	126	M205OR03.8032-3.2A
35.0	42.5	3.2	35.0	127	M205OR03.8035-3.2A
36.0	43.5	3.2	36.0	128	M205OR03.8036-3.2A
40.0	51.0	4.2	40.0	224	M205OR05.5040-4.2A
42.0	53.0	4.2	42.0	224	M205OR05.5042-4.2A

\*If used with wear rings, refer to wear ring throat diameter, see Section 9.  
 For custom groove calculations, see Appendix C.

## OR Profile

Table 5-42. OR Gland Dimensions — Metric (continued)

A Rod Diameter	B Groove Diameter	C Groove Width	D Throat Diameter*	O-ring Dash Number	Part Number
f7	H9	+ .20/- .00	H8		
For ISO tolerances refer to Appendix F.					
45.0	56.0	4.2	45.0	225	M205OR05.5045-4.2A
48.0	59.0	4.2	48.0	226	M205OR05.5048-4.2A
50.0	61.0	4.2	50.0	227	M205OR05.5050-4.2A
52.0	63.0	4.2	52.0	227	M205OR05.5052-4.2A
55.0	66.0	4.2	55.0	228	M205OR05.5055-4.2A
56.0	67.0	4.2	56.0	229	M205OR05.5056-4.2A
60.0	71.0	4.2	60.0	230	M205OR05.5060-4.2A
63.0	74.0	4.2	63.0	231	M205OR05.5063-4.2A
65.0	76.0	4.2	65.0	232	M205OR05.5065-4.2A
70.0	81.0	4.2	70.0	233	M205OR05.5070-4.2A
75.0	86.0	4.2	75.0	234	M205OR05.5075-4.2A
80.0	91.0	4.2	80.0	236	M205OR05.5080-4.2A
85.0	96.0	4.2	85.0	237	M205OR05.5085-4.2A
90.0	101.0	4.2	90.0	239	M205OR05.5090-4.2A
95.0	106.0	4.2	95.0	241	M205OR05.5095-4.2A
100.0	111.0	4.2	100.0	243	M205OR05.5100-4.2A
105.0	116.0	4.2	105.0	242	M205OR05.5105-4.2A
110.0	121.0	4.2	110.0	246	M205OR05.5110-4.2A
115.0	126.0	4.2	115.0	247	M205OR05.5115-4.2A
120.0	131.0	4.2	120.0	248	M205OR05.5120-4.2A
125.0	136.0	4.2	125.0	250	M205OR05.5125-4.2A
130.0	141.0	4.2	130.0	251	M205OR05.5130-4.2A
135.0	146.0	4.2	135.0	253	M205OR05.5135-4.2A
140.0	151.0	4.2	140.0	255	M205OR05.5140-4.2A
150.0	161.0	4.2	150.0	257	M205OR05.5150-4.2A
160.0	171.0	4.2	160.0	259	M205OR05.5160-4.2A
170.0	181.0	4.2	170.0	261	M205OR05.5170-4.2A
180.0	191.0	4.2	180.0	263	M205OR05.5180-4.2A
190.0	201.0	4.2	190.0	264	M205OR05.5190-4.2A
200.0	215.5	6.3	200.0	369	M205OR07.8200-6.3A
210.0	225.5	6.3	210.0	370	M205OR07.8210-6.3A
220.0	235.5	6.3	220.0	372	M205OR07.8220-6.3A
230.0	245.5	6.3	230.0	374	M205OR07.8230-6.3A
240.0	255.5	6.3	240.0	375	M205OR07.8240-6.3A
250.0	265.5	6.3	250.0	377	M205OR07.8250-6.3A
280.0	301.0	8.1	280.0	451	M205OR10.5280-8.1A
300.0	321.0	8.1	300.0	453	M205OR10.5300-8.1A
320.0	341.0	8.1	320.0	454	M205OR10.5320-8.1A
350.0	371.0	8.1	350.0	456	M205OR10.5350-8.1A
360.0	381.0	8.1	360.0	457	M205OR10.5360-8.1A
400.0	421.0	8.1	400.0	460	M205OR10.5400-8.1A
420.0	441.0	8.1	420.0	462	M205OR10.5420-8.1A
450.0	471.0	8.1	450.0	465	M205OR10.5450-8.1A
480.0	501.0	8.1	480.0	467	M205OR10.5480-8.1A
500.0	521.0	8.1	500.0	469	M205OR10.5500-8.1A
600.0	621.0	8.1	600.0	472	M205OR10.5600-8.1A

\*If used with wear rings, refer to wear ring throat diameter, see Section 9.

For custom groove calculations, see Appendix C.

NOTE: For sizes larger than those shown in the table, please contact your local Parker Seal representative.

09/01/07





# Symmetrical Seals for Rod or Piston Applications

Catalog EPS 5370/USA

## Contents

Product Offering .....	6-2
Decision Tree .....	5-3 and 5-4, ..... 7-3 and 7-4
PolyPak Sealing.....	6-3
Profiles	
Standard PolyPak.....	6-6
Deep PolyPak.....	6-8
Type B PolyPak.....	6-10
SL .....	6-39
US .....	6-42
8400 and 8500 .....	6-49
AN6226 .....	6-55
Spiral Vee .....	6-59

## Symmetrical Profiles











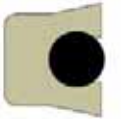





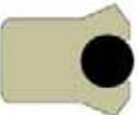

Parker symmetrical profiles are designed to fit the center of the gland. They are categorized as symmetrical profiles because the shape of the outside diameter sealing lip matches the shape of the inside diameter sealing lip. This symmetrical design, with its centered fit in the gland, allows the profile to function either as a rod or piston seal. Parker's wide range of profile options, proprietary compounds, and sizes establish Parker as a leader in the industry, providing quality solutions for pneumatic and hydraulic applications.

# Symmetrical Seal Product Offering (For Rod or Piston Applications)











Catalog EPS 5370/USA

## Profiles

Table 6-1: Product Profiles

Series	Description	Application (Duty)				Page
		Light	Medium	Heavy	Pneumatic	
SPP 	Square Cross-Section O-ring Energized Lip Seal					6-6
DPP 	O-ring Loaded Lip Seal with Scraper Lip Design					6-8
BPP 	O-ring Energized Lip Seal with Beveled Lip Design					6-10
SL 	Dual Compound Dual Lip Seal					6-39
US 	Symmetrical U-cup Seal					6-42

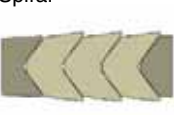
Series	Description	Application (Duty)				Page
		Light	Medium	Heavy	Pneumatic	
8400 	Light Load U-cup with Beveled Lips					6-49
8500 	Light Load U-cup with Scraper Lips					6-49
AN6226 	Symmetrical U-cup per Army Navy (AN) Specification					6-55
Spiral 	Cut to Size Chevron Packing					6-59

## Symmetrical Seal Decision Tree

The Symmetrical product offerings are a part of the Decision Trees in the Rod and Piston sections (Sections 5 and 7). These Decision Trees are found on pages 5-3, 5-4, 7-3 and 7-4.

09/01/07



# Symmetrical Seals

## PolyPak Sealing

Catalog EPS 5370/USA



### PolyPak Sealing

Parker's PolyPak seal is a patented precision molded multi-purpose seal. The Parker PolyPak combines an o-ring type synthetic rubber o-spring with a conventional lip-type seal to produce a unique sealing device capable of sealing both vacuum, high and low pressure.

Conventional lip seals, such as the standard u-cups are prone to leakage under low pressure because little or no lip loading is inherent in the basic seal design. The Parker PolyPak however, is a squeeze type seal and provides high sealability at low pressure. As system pressure increases, additional force is applied to the PolyPak's seal interface and as pressure continues to increase, lip loading is automatically increased to compensate for this higher pressure and thus maintain a positive, leak-free seal from hard vacuum to over 60,000 psi with proper design and auxiliary devices.

In addition to providing superior sealing in vacuum, low and high pressure applications, the PolyPak seal offers a number of distinct advantages over conventional symmetrical or non-symmetrical u-cup seals including:

- The PolyPak's o-spring stabilizes the seal under extreme pressures, preventing seal lip distortion and rolling or twisting in the gland.
- At low or high temperature extremes, the o-spring maintains lip loading on both I.D. and O.D. of the seal interface.
- The PolyPak seal can be stretched or squeezed to accommodate oversize cylinder bores and undersize rods. As long as the seal cross-section is correct in relation to the radial groove dimensions, the PolyPak will compensate and maintain proper lip loading.
- The range of materials available to the user of the PolyPak seal insures the proper combination for abrasion, extrusion, temperature resistance and fluid compatibility which produces high sealability and long life.

PolyPak seals are available in three styles:

1. Standard PolyPak (SPP Profile)
2. Deep PolyPak (DPP Profile)
3. Type B PolyPak (BPP Profile)

6

09/01/07

### Rod Sealing with PolyPak Seals

As a general rule, rod seals are more critical in nature than their companion piston seals. With increasing OEM requirements for “dry rod” capability, both to conserve system fluid and avoid leakage, the design and selection of the rod seal can be more challenging than its piston counterpart.

Parker recommends the use of the Type B PolyPak (BPP Profile) for rod seal applications due to its design features, including:

- Excellent film-breaking capability of the beveled lip design
- The higher level of lip loading provided by the Type B offers maximum sealability
- The long body of the design provides maximum stability

### Piston Sealing with PolyPak Seals

Piston seals can be classified in two categories: single-acting and double-acting. The single acting seal is only required to seal in a single direction as system pressure is seen on only one end of the piston (return of the piston in a single-acting system is accomplished either by gravity or spring loading). The double-acting cylinder requires that the piston be sealed in both directions of stroke as system fluid is applied to one side or the other to achieve movement.

Please see the individual PolyPak profile pages for explanation and differentiation on selecting PolyPak profiles for piston applications.

### PolyPak Material Combinations

PolyPak seals can be configured in numerous o-spring energizer and shell combinations. Table 6-2 represents “standard” combinations. Care should be taken to insure that both the PolyPak shell and its companion o-spring energizer are compatible with the system temperature, pressure, and fluid requirements.

**Table 6-2. Standard Shell and O-spring Energizer Combinations for PolyPak Seals**

PolyPak Shell	O-spring Energizer
Molythane	70A Nitrile
PolyMyte	70A Nitrile, 75A FKM
Nitroxile	70A Nitrile
Ethylene Propylene	80A EPR
Fluorocarbon	75A FKM
All Plastic and Rubber	Metal O-spring

Parker's “smart” part numbering provides for varying standard and custom PolyPak shell and o-spring energizer material combinations. Please refer to the part number nomenclature tables and Technical Data in the PolyPak profile pages for PolyPak shell material options. See Table 6-3 for standard and custom o-spring energizer option details.

### Positively-Actuated Back-ups Option

PolyPak seals can be designed with positively-actuated back-ups by designating that option in the part number. See page 10-21 for an explanation of the features of positively-actuated back-ups.

Table 6-3. PolyPak O-spring Energizers

Standard O-spring Energizer		
O-spring Energizer Code	Type of PolyPak	Description
– (dash)	Urethane (4615, 4622)	70A NBR o-spring energizer
	Rubber	Indicates that the o-spring material family is to match the rubber PolyPak shell material family. Example: XNBR 4263 PolyPak shell: code (“–”) indicates NBR o-ring EPR 4207 PolyPak shell: code (“–”) indicates EPR o-ring FKM 4208 PolyPak shell: code (“–”) indicates FKM o-ring FKM 4266 PolyPak shell: code (“–”) indicates FKM o-ring
	PolyMyte (4651)	must be replaced by a custom o-spring energizer code
Custom O-spring Energizers		
O-spring Energizer Code	Energizer Description	
C	Continuous o-ring	
E	General EPR o-ring	
J	General HNBR o-ring	
L	Canted coil, spring-loaded with oval spring cavity	
N	General nitrile o-ring	
R	Low swell nitrile o-ring	
S	Spring energizer with o-ring groove	
U	Geothermal EPR o-ring	
V	Fluorocarbon o-ring	
W	Nuclear grade EPR o-ring	
X	Premium grade low-temperature o-ring	
Y	Low temperature nitrile o-ring	

# Symmetrical Seal SPP Profile, Standard PolyPak

Catalog EPS 5370/USA



## SPP Profile, Standard PolyPak, Square Cross-Section O-ring Energized Lip Seal

Parker's Standard PolyPak is a squeeze seal with a symmetrical profile for use in either rod or piston applications. The standard Molythane shell provides high wear resistance and the o-ring energizer functions as a spring to maintain sealing contact under low pressure. The Standard PolyPak utilizes a scraper lip design formed by a precision trimming process. The scraper edge wipes both fluid film and contamination away from the seal. A wide selection of sizes and alternate compounds allow this profile to match up with many hydraulic applications. The Standard PolyPak is an economical choice as a stand alone rod or piston seal. With less squeeze force than the Deep or Type B profiles, the Standard PolyPak can be installed back to back, in separate glands, for bi-directional sealing. To protect against pressure trapping, it is recommended that the o-ring be removed from the Standard PolyPak facing the lower pressure side of the application.

### Technical Data

Standard Materials*	Temperature Range	Pressure Range†	Surface Speed
<b>Shell</b>			
P4615A90	-65°F to 200°F (-54°C to 93°C)	5000 psi (345 bar)	< 1.6 ft/s (0.5 m/s)
P4622A90	-65°F to 225°F (-54°C to 107°C)	5000 psi (345 bar)	< 1.6 ft/s (0.5 m/s)
Z4651D60	-65°F to 275°F (-54°C to 135°C)	7000 psi (482 bar)	< 1.6 ft/s (0.5 m/s)
N4263A90	-20°F to 275°F (-29°C to 135°C)	2000 psi (138 bar)	< 1.6 ft/s (0.5 m/s)
E4207A90	-65°F to 300°F (-54°C to 149°C)	2000 psi (138 bar)	< 1.6 ft/s (0.5 m/s)
V4208A90	-5°F to 400°F (-21°C to 204°C)	2250 psi (155 bar)	< 1.6 ft/s (0.5 m/s)
V4266A95	-5°F to 400°F (-21°F to 204°C)	2250 psi (155 bar)	< 1.6 ft/s (0.5 m/s)



Standard PolyPak Cross-Section

### Energizer

#### For Seals With...

4615 or 4622 PolyPak shell  
4651 PolyPak shell  
Rubber PolyPak shell

#### Standard Energizer Material\*

Standard energizer is a nitrile o-ring  
O-spring energizer code must be identified  
Standard energizer is an o-ring from the same rubber material family as the shell

**\*Alternate Materials:** For custom energizer materials, see Table 6-3. For applications that may require an alternate shell material, please see Section 3 or contact your local Parker Seal representative.

**†Pressure Range** without wear rings (see Table 2-4, page 2-5).

09/01/07



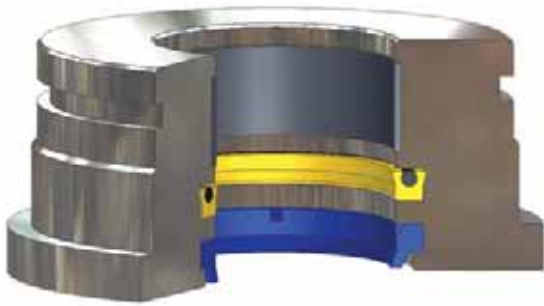

*Standard PolyPak installed in Rod Gland*

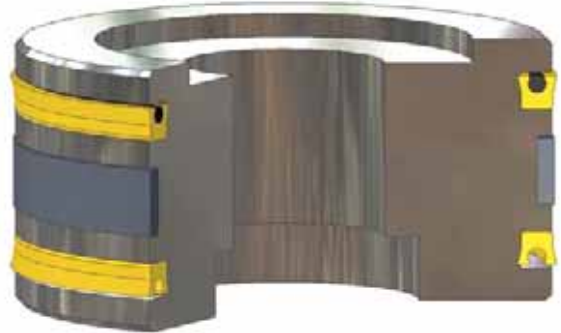

*Standard PolyPak installed in Piston Gland*

**Part Number Nomenclature — Standard PolyPak Profile**

**Table 6-4. Standard PolyPak Profile — Inch**

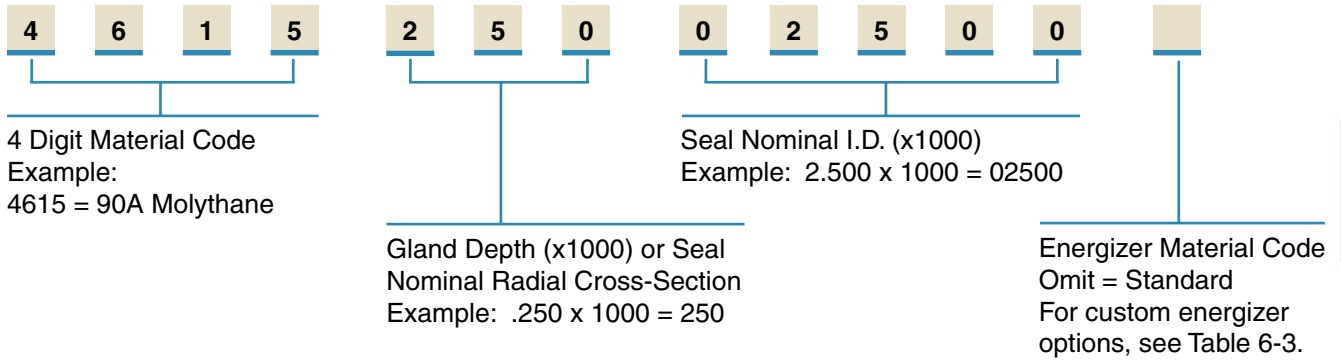

**Gland Dimensions — Standard PolyPak Profile**

Standard PolyPak gland dimensions are provided on in Table 6-8, page 6-12.

# Symmetrical Seal DPP Profile, Deep PolyPak

Catalog EPS 5370/USA

## DPP Profile, Deep PolyPak, O-ring Loaded Lip Seal with Scraper Lip Design



Parker's Deep PolyPak is a squeeze seal with a symmetrical profile for use in either rod or piston applications. Its rectangular shape ensures stability in the gland. The standard Molythane shell provides high wear resistance and the o-ring energizer functions as a spring to maintain sealing contact under low pressure or vacuum applications. The Deep PolyPak scraper lip design cuts fluid film and moves contamination away from the seal. The sharp edge of the lip is formed by a precision knife trimming process. A wide selection of sizes and alternate compounds allow this profile to match up with many hydraulic applications. The Deep PolyPak is an economical choice as a stand alone rod or piston seal. Deep PolyPak seals should not be installed back to back in bi-directional piston applications as a pressure trap between the seals may occur.

### Technical Data

Standard Materials*	Temperature Range	Pressure Range†	Surface Speed
<b>Shell</b>			
P4615A90	-65°F to 200°F (-54°C to 93°C)	5,000 psi (344 bar)	< 1.6 ft/s (0.5 m/s)
P4622A90	-65°F to 225°F (-54°C to 107°C)	5,000 psi (344 bar)	< 1.6 ft/s (0.5 m/s)
Z4651D60	-65°F to 275°F (-54°C to 135°C)	7,000 psi (482 bar)	< 1.6 ft/s (0.5 m/s)
N4263A90	-20°F to 275°F (-29°C to 135°C)	2,000 psi (137 bar)	< 1.6 ft/s (0.5 m/s)
E4207A90	-65°F to 300°F (-54°C to 149°C)	2,000 psi (137 bar)	< 1.6 ft/s (0.5 m/s)
V4208A90	-5°F to 400°F (-21°C to 204°C)	2250 psi (155 bar)	< 1.6 ft/s (0.5 m/s)
V4266A95	-5°F to 400°F (-21°C to 204°C)	2,250 psi (155 bar)	< 1.6 ft/s (0.5 m/s)

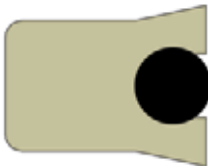

Deep PolyPak Cross-Section

### Energizer

#### For Seals With...

4615 or 4622 PolyPak shell  
4651 PolyPak shell  
Rubber PolyPak shell

#### Standard Energizer Material\*

Standard energizer is a nitrile o-ring  
O-spring energizer code must be identified  
Standard energizer is an o-ring from the same rubber material family as the shell

**\*Alternate Materials:** For custom energizer materials, see Table 6-3. For applications that may require an alternate shell material, please see Section 3 or contact your local Parker Seal representative.

**†Pressure Range** without wear rings (see Table 2-4, page 2-5).

09/01/07

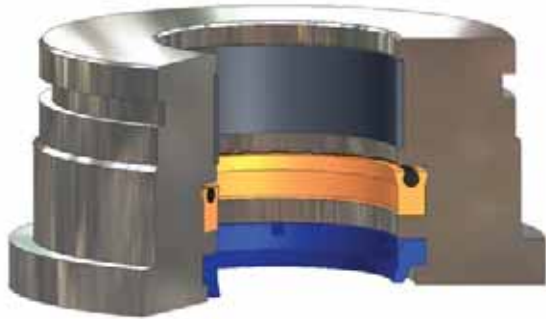

*Deep PolyPak installed in Rod Gland*

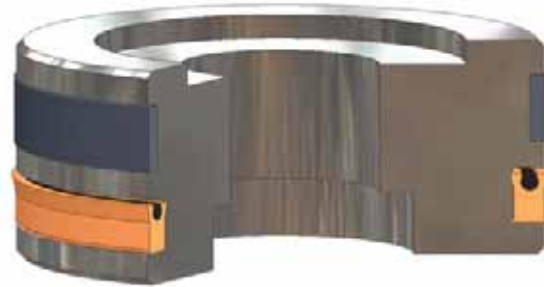

*Deep PolyPak installed in Piston Gland*

### Part Number Nomenclature — Deep PolyPak Profile

Table 6-5. Deep PolyPak Profile — Inch

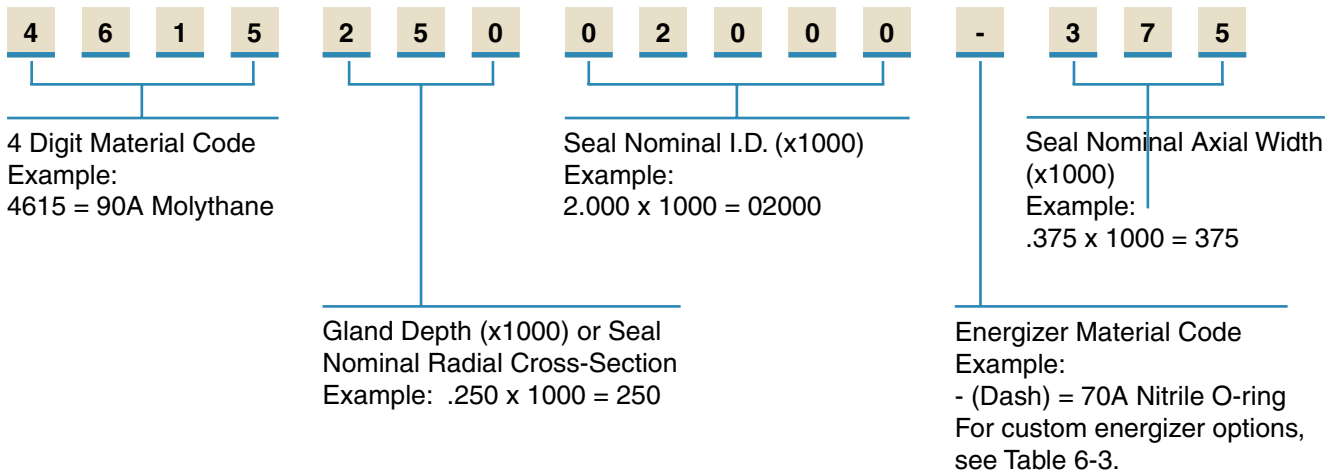

### Gland Dimensions — Deep PolyPak Profile

Deep PolyPak gland dimensions are provided in Table 6-8, page 6-12.

# Symmetrical Seal BPP Profile, Type B PolyPak

Catalog EPS 5370/USA

## BPP Profile, Type B PolyPak O-ring Energized Lip Seal with Beveled Lip Design



Parker's Type B PolyPak is a squeeze seal with a symmetrical profile for use in either rod or piston applications. The rectangular shape of its cross section ensures stability in the gland. The standard Molythane shell provides high wear resistance and the o-ring energizer functions as a spring to maintain sealing contact under low pressure or vacuum applications. The beveled lip design of the Type B PolyPak is excellent for cutting fluid film. The sharp beveled lip is formed by a precision knife trimming process. A wide selection of sizes and alternate compounds allow this profile to match up with many hydraulic applications. The Type B PolyPak is an economical choice as a stand-alone seal or can be used in tandem with a buffer seal. In piston applications, this seal will function as a unidirectional seal. Instead, for bi-directional piston sealing, incorporate a PIP ring (see page 7-15). Type B PolyPaks should not be installed back to back, in bi-directional pressure applications, as a pressure trap between the seals may occur.

6

### Technical Data

Standard Materials*	Temperature Range	Pressure Range†	Surface Speed
<b>Shell</b>			
P4615A90	-65°F to 200°F (-54°C to 93°C)	5,000 psi (344 bar)	< 1.6 ft/s (0.5 m/s)
P4622A90	-65°F to 225°F (-54°C to 107°C)	5,000 psi (344 bar)	< 1.6 ft/s (0.5 m/s)
Z4651D60	-65°F to 275°F (-54°C to 135°C)	7,000 psi (482 bar)	< 1.6 ft/s (0.5 m/s)
N4263A90	-20°F to 275°F (-29°C to 135°C)	7,000 psi (482 bar)	< 1.6 ft/s (0.5 m/s)
E4207A90	-65°F to 300°F (-54°C to 149°C)	2,000 psi (137 bar)	< 1.6 ft/s (0.5 m/s)
V4208A90	-5°F to 400°F (-21°C to 204°C)	2250 psi (155 bar)	< 1.6 ft/s (0.5 m/s)
V4266A95	-5°F to 400°F (-21°C to 204°C)	2,250 psi (155 bar)	< 1.6 ft/s (0.5 m/s)

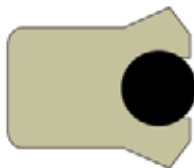

Type B PolyPak  
Cross-Section

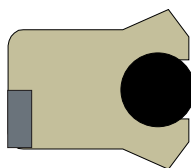

Type B PolyPak  
with Back-up  
Cross-Section

### Energizer

#### For Seals With...

4615 or 4622 PolyPak shell  
4651 PolyPak shell  
Rubber PolyPak shell

#### Standard Energizer Material\*

Standard energizer is a nitrile o-ring  
O-spring energizer code must be identified  
Standard energizer is an o-ring from the same rubber material family as the shell

**\*Alternate Materials:** For custom energizer materials, see Table 6-3. For applications that may require an alternate shell material, please see Section 3 or contact your local Parker Seal representative.

†Pressure Range without wear rings (see Table 2-4, page 2-5).

09/01/07

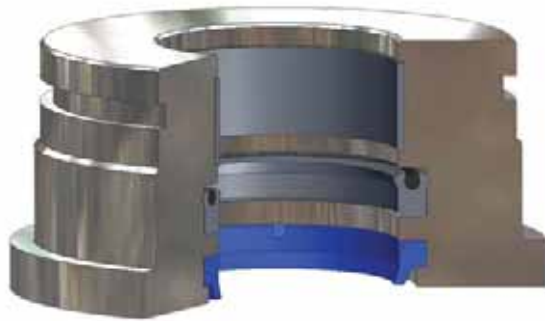

*Type B PolyPak installed in Rod Gland*



*Type B PolyPak installed in Piston Gland*

**Part Number Nomenclature — Type B PolyPak Profile**

**Table 6-6. Type B PolyPak Profile — Inch**

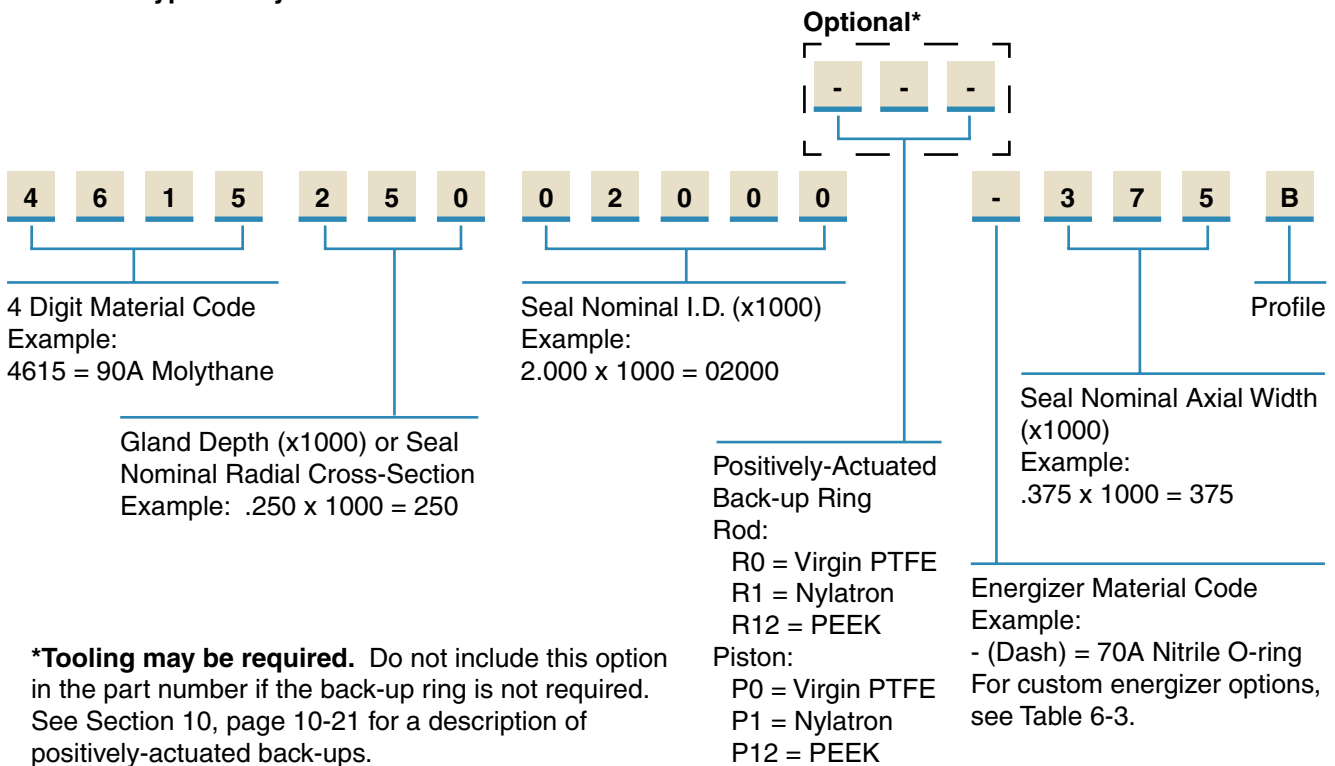

**Gland Dimensions — Type B PolyPak Profile**

Type B PolyPak gland dimensions are provided in Table 6-8, page 6-12.

# Standard, Deep and Type B PolyPak Gland Dimensions

Catalog EPS 5370/USA

## Gland Dimensions — Standard, Deep and Type B PolyPak Profiles

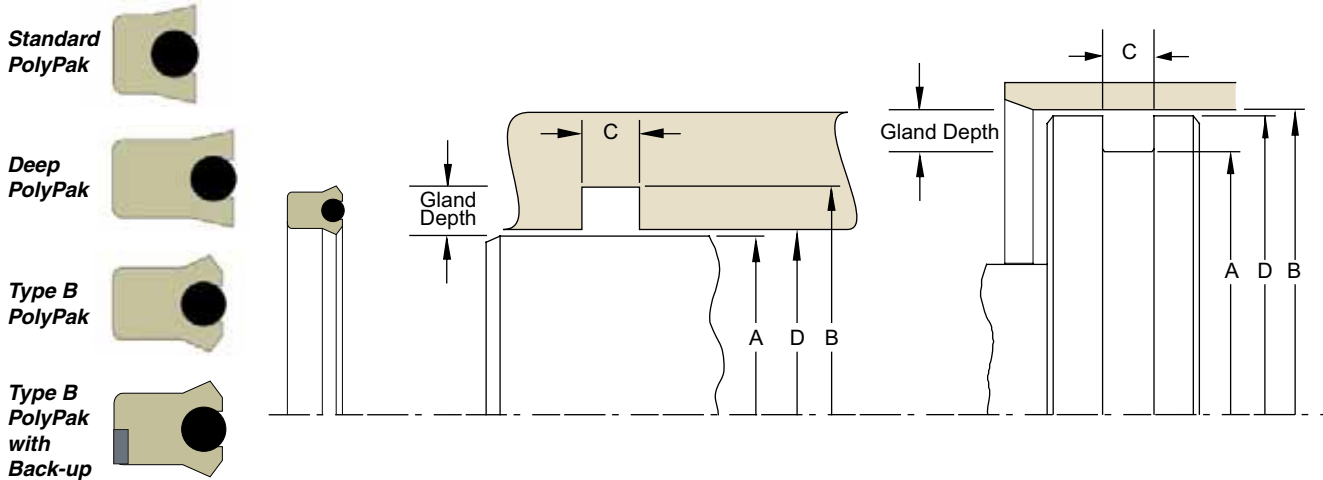

Table 6-7A. Rod Gland Dimension Tolerances

Nominal Gland Depth	A Rod Diameter	B Groove Diameter	C Groove Width	D Throat Diameter
1/8	+0.00/-0.001	+0.02/-0.000	+0.15/-0.000	+0.02/-0.000
3/16	+0.00/-0.002	+0.02/-0.000		+0.02/-0.000
1/4	+0.00/-0.002	+0.03/-0.000		+0.03/-0.000
5/16	+0.00/-0.002	+0.04/-0.000		+0.03/-0.000
3/8	+0.00/-0.002	+0.05/-0.000		+0.04/-0.000
7/16	+0.00/-0.003	+0.06/-0.000		+0.04/-0.000
1/2	+0.00/-0.003	+0.07/-0.000		+0.05/-0.000
5/8	+0.00/-0.003	+0.09/-0.000		+0.06/-0.000
3/4	+0.00/-0.004	+0.11/-0.000		+0.07/-0.000
1	+0.00/-0.005	+0.15/-0.000		+0.09/-0.000

Table 6-7B. Piston Gland Dimension Tolerances

Nominal Gland Depth	B Bore Diameter	A Groove Diameter	C Groove Width	D Piston Diameter
1/8	+0.02/-0.000	+0.00/-0.002	+0.15/-0.000	+0.00/-0.001
3/16	+0.02/-0.000	+0.00/-0.002		+0.00/-0.002
1/4	+0.03/-0.000	+0.00/-0.003		+0.00/-0.002
5/16	+0.03/-0.000	+0.00/-0.004		+0.00/-0.002
3/8	+0.04/-0.000	+0.00/-0.005		+0.00/-0.002
7/16	+0.05/-0.000	+0.00/-0.006		+0.00/-0.002
1/2	+0.05/-0.000	+0.00/-0.007		+0.00/-0.003
9/16	+0.06/-0.000	+0.00/-0.008		+0.00/-0.003
5/8	+0.06/-0.000	+0.00/-0.009		+0.00/-0.003
3/4	+0.07/-0.000	+0.00/-0.010		+0.00/-0.004
7/8	+0.08/-0.000	+0.00/-0.011	+0.00/-0.005	
1	+0.09/-0.000	+0.00/-0.012	+0.00/-0.005	

Please refer to Engineering Section 2, page 2-8 for surface finish and additional hardware considerations.

Table 6-8. Standard, Deep and Type B PolyPak Gland Dimensions

A Rod Diameter	B (Rod) Groove Diameter	C		D		Compound Codes (X = Standard Offering)†						Part Number				
		(Std. PP) Groove Width	(Deep & B) Groove Width	Throat Diameter*	Piston Diameter**	Standard PP		Deep PP		Type B		Compound Code	Energizer Code	Add to the part number for Type B or Deep only	Add to the part number for Type B only	
(Bore) Groove Diameter	Bore Diameter					Plastic	Rubber	Plastic	Rubber	Plastic	Rubber					
0.062	0.312	0.138	0.275	0.063	0.311	X						XXXX	12500062	-	250	B
0.093	0.343	0.138	0.275	0.094	0.342	X	X					XXXX	12500093	-	250	B
0.125	0.375	0.138	0.275	0.126	0.374	X	X		X	X		XXXX	12500125	-	250	B
0.140	0.390	0.138	0.275	0.141	0.389	X						XXXX	12500140	-	250	B

†For plastic compounds, see Table 3-1, page 3-11. For rubber compounds, see Table 3-3, page 3-14.  
 \*If used with wear rings, refer to wear ring throat diameter, see Section 9.  
 \*\*If used with wear rings, refer to wear ring piston diameter, see Section 9.  
 For custom groove calculations, see Appendix C.

09/01/07





Table 6-8. Standard, Deep and Type B PolyPak Gland Dimensions — Inch (Continued)

A Rod Diameter	B (Rod) Groove Diameter	C		D		Compound Codes (X = Standard Offering)†						Part Number				
		(Std. PP) Groove Width	(Deep & B) Groove Width	Throat Diameter*	Piston Diameter**	Standard PP		Deep PP		Type B		Compound Code	Energizer Code	Add to the part number for Type B or Deep only	Add to the part number for Type B only	
(Bore) Groove Diameter	Bore Diameter					Plastic	Rubber	Plastic	Rubber	Plastic	Rubber					
0.187	0.437	0.138	0.275	0.188	0.436	X	X			X	X	XXXX	12500187	-	250	B
0.187	0.562	0.206	0.343	0.188	0.561	X	X					XXXX	18700187	-	312	B
0.187	0.750	0.309	0.550	0.188	0.749	X						XXXX	28100187	-	500	B
0.218	0.468	0.138	0.275	0.219	0.467					X		XXXX	12500218	-	250	B
0.250	0.500	0.138	0.275	0.251	0.499	X	X	X		X	X	XXXX	12500250	-	250	B
0.250	0.625	0.206	0.343	0.251	0.624	X	X	X		X		XXXX	18700250	-	312	B
0.250	0.750	0.275	0.413	0.251	0.749	X				X		XXXX	25000250	-	375	B
0.250	0.875	0.343	0.550	0.252	0.873	X						XXXX	31200250	-	500	B
0.312	0.562	0.138	0.275	0.313	0.561	X	X	X		X	X	XXXX	12500312	-	250	B
0.312	0.687	0.206	0.343	0.313	0.686	X				X		XXXX	18700312	-	312	B
0.312	0.750	0.240	0.413	0.313	0.749	X						XXXX	21800312	-	375	B
0.312	0.812	0.275	0.413	0.313	0.811	X					X	XXXX	25000312	-	375	B
0.359	0.609	0.138	0.275	0.360	0.608	X						XXXX	12500359	-	250	B
0.375	0.625	0.138	0.206	0.376	0.624	X	X			X		XXXX	12500375	-	187	B
0.375	0.625	0.138	0.275	0.376	0.624					X	X	XXXX	12500375	-	250	B
0.375	0.750	0.206	0.293	0.376	0.749	X	X			X		XXXX	18700375	-	266	B
0.375	0.750	0.206	0.343	0.376	0.749			X	X	X		XXXX	18700375	-	312	B
0.375	0.875	0.275	0.413	0.376	0.874	X	X	X			X	XXXX	25000375	-	375	B
0.375	1.000	0.343	0.550	0.377	0.998	X						XXXX	31200375	-	500	B
0.437	0.687	0.138	0.275	0.438	0.686	X	X	X		X		XXXX	12500437	-	250	B
0.437	0.750	0.172	0.275	0.438	0.749	X						XXXX	15600437	-	250	B
0.437	0.812	0.206	0.343	0.438	0.811	X	X	X		X		XXXX	18700437	-	312	B
0.437	0.875	0.240	0.413	0.438	0.874	X						XXXX	21800437	-	375	B
0.437	0.937	0.275	0.413	0.438	0.936	X	X	X		X		XXXX	25000437	-	375	B
0.437	1.062	0.343	0.550	0.439	1.060	X						XXXX	31200437	-	500	B
0.500	0.750	0.138	0.138	0.501	0.749	X	X			X	X	XXXX	12500500	-	125	B
0.500	0.750	0.138	0.275	0.501	0.749			X	X	X	X	XXXX	12500500	-	250	B
0.500	0.875	0.206	0.343	0.501	0.874	X	X			X	X	XXXX	18700500	-	312	B
0.500	1.000	0.275	0.413	0.501	0.999	X		X		X		XXXX	25000500	-	375	B
0.500	1.125	0.343	0.550	0.502	1.123	X	X					XXXX	31200500	-	500	B
0.500	1.250	0.413	0.688	0.502	1.248	X						XXXX	37500500	-	625	B
0.531	0.781	0.138	0.275	0.532	0.780	X						XXXX	12500531	-	250	B
0.562	0.812	0.138	0.138	0.563	0.811	X	X			X		XXXX	12500562	-	125	B
0.562	0.812	0.138	0.275	0.563	0.811					X	X	XXXX	12500562	-	250	B
0.562	0.936	0.206	0.343	0.563	0.935	X				X	X	XXXX	18700562	-	312	B
0.562	1.000	0.240	0.413	0.563	0.999	X						XXXX	21800562	-	375	B
0.562	1.062	0.275	0.413	0.563	1.061	X				X		XXXX	25000562	-	375	B
0.625	0.875	0.138	0.138	0.626	0.874		X			X	X	XXXX	12500625	-	125	B
0.625	0.875	0.138	0.206	0.626	0.874	X		X		X		XXXX	12500625	-	187	B
0.625	0.875	0.138	0.227	0.626	0.874						X	XXXX	12500625	-	206	B
0.625	0.875	0.138	0.275	0.626	0.874			X	X	X	X	XXXX	12500625	-	250	B
0.625	1.000	0.206	0.343	0.626	0.999	X	X	X	X	X	X	XXXX	18700625	-	312	B

†For plastic compounds, see Table 3-1, page 3-11. For rubber compounds, see Table 3-3, page 3-14.

\*If used with wear rings, refer to wear ring throat diameter, see Section 9.

\*\*If used with wear rings, refer to wear ring piston diameter, see Section 9.

For custom groove calculations, see Appendix C.



**Standard, Deep and Type B PolyPak Profile**

**Table 6-8. Standard, Deep and Type B PolyPak Gland Dimensions — Inch (Continued)**

A Rod Diameter	B (Rod) Groove Diameter	C		D		Compound Codes (X = Standard Offering)†						Part Number				
		(Std. PP) Groove Width	(Deep & B) Groove Width	Throat Diameter*	Piston Diameter**	Standard PP		Deep PP		Type B		Compound Code	Energi-zer Code	Add to the part number for Type B or Deep only	Add to the part number for Type B only	
(Bore) Groove Diameter	Bore Diameter					Plastic	Rubber	Plastic	Rubber	Plastic	Rubber					
0.625	1.125	0.275	0.413	0.626	1.124	X	X	X	X	X	X	XXXX	25000625	-	375	B
0.625	1.250	0.343	0.550	0.627	1.248	X						XXXX	31200625	-	500	B
0.625	1.375	0.413	0.688	0.627	1.373	X						XXXX	37500625	-	625	B
0.656	1.031	0.206	0.343	0.657	1.030	X						XXXX	18700656	-	312	B
0.687	0.937	0.138	0.275	0.688	0.936	X	X	X		X	X	XXXX	12500687	-	250	B
0.687	1.061	0.206	0.206	0.688	1.060	X	X				X	XXXX	18700687	-	187	B
0.687	1.061	0.206	0.343	0.688	1.060					X		XXXX	18700687	-	312	B
0.687	1.187	0.275	0.413	0.688	1.186	X				X		XXXX	25000687	-	375	B
0.687	1.250	0.309	0.550	0.688	1.249	X						XXXX	28100687	-	500	B
0.687	1.312	0.343	0.550	0.689	1.310	X						XXXX	31200687	-	500	B
0.750	1.000	0.138	0.138	0.751	0.999	X	X			X		XXXX	12500750	-	125	B
0.750	1.000	0.138	0.206	0.751	0.999					X		XXXX	12500750	-	187	B
0.750	1.000	0.138	0.275	0.751	0.999			X	X	X	X	XXXX	12500750	-	250	B
0.750	1.062	0.172	0.275	0.751	1.061	X						XXXX	15600750	-	250	B
0.750	1.125	0.206	0.275	0.751	1.124			X	X			XXXX	18700750	-	250	B
0.750	1.125	0.206	0.343	0.751	1.124	X	X	X		X	X	XXXX	18700750	-	312	B
0.750	1.188	0.240	0.413	0.751	1.187	X						XXXX	21800750	-	375	B
0.750	1.250	0.275	0.413	0.751	1.249	X	X	X	X	X	X	XXXX	25000750	-	375	B
0.750	1.375	0.343	0.550	0.752	1.373	X	X	X		X		XXXX	31200750	-	500	B
0.750	1.500	0.413	0.688	0.752	1.498	X		X				XXXX	37500750	-	625	B
0.800	1.050	0.138	0.275	0.801	1.049					X		XXXX	12500800	-	250	B
0.812	1.062	0.138	0.138	0.813	1.061	X	X			X		XXXX	12500812	-	125	B
0.812	1.062	0.138	0.275	0.813	1.061					X		XXXX	12500812	-	250	B
0.812	1.186	0.206	0.343	0.813	1.185	X	X	X		X	X	XXXX	18700812	-	312	B
0.812	1.312	0.275	0.413	0.813	1.311	X						XXXX	25000812	-	375	B
0.812	1.436	0.343	0.550	0.814	1.434	X				X		XXXX	31200812	-	500	B
0.875	1.125	0.138	0.138	0.876	1.124	X	X			X	X	XXXX	12500875	-	125	B
0.875	1.125	0.138	0.206	0.876	1.124			X		X		XXXX	12500875	-	187	B
0.875	1.125	0.138	0.275	0.876	1.124			X	X	X	X	XXXX	12500875	-	250	B
0.875	1.250	0.206	0.275	0.876	1.249				X			XXXX	18700875	-	250	B
0.875	1.250	0.206	0.343	0.876	1.249	X	X	X	X	X		XXXX	18700875	-	312	B
0.875	1.250	0.206	0.413	0.876	1.249			X				XXXX	18700875	-	375	B
0.875	1.375	0.275	0.413	0.876	1.374	X	X			X	X	XXXX	25000875	-	375	B
0.875	1.500	0.343	0.550	0.877	1.498	X						XXXX	31200875	-	500	B
0.875	1.625	0.413	0.688	0.877	1.623	X						XXXX	37500875	-	625	B
0.906	1.156	0.138	0.275	0.907	1.155	X						XXXX	12500906	-	250	B
0.937	1.187	0.138	0.275	0.938	1.186	X	X			X		XXXX	12500937	-	250	B
0.937	1.250	0.172	0.275	0.938	1.249	X	X					XXXX	15600937	-	250	B
0.937	1.312	0.206	0.343	0.938	1.311	X	X			X	X	XXXX	18700937	-	312	B
0.937	1.375	0.240	0.413	0.938	1.374	X						XXXX	21800937	-	375	B
0.937	1.437	0.275	0.413	0.938	1.436	X						XXXX	25000937	-	375	B
0.937	1.687	0.413	0.688	0.939	1.685	X						XXXX	37500937	-	625	B

†For plastic compounds, see Table 3-1, page 3-11. For rubber compounds, see Table 3-3, page 3-14.

\*If used with wear rings, refer to wear ring throat diameter, see Section 9.

\*\*If used with wear rings, refer to wear ring piston diameter, see Section 9.

For custom groove calculations, see Appendix C.



Table 6-8. Standard, Deep and Type B PolyPak Gland Dimensions — Inch (Continued)

A Rod Diameter	B (Rod) Groove Diameter	C		D		Compound Codes (X = Standard Offering)†						Part Number				
		(Std. PP) Groove Width	(Deep & B) Groove Width	Throat Diameter*	Piston Diameter**	Standard PP		Deep PP		Type B		Compound Code	Energizer Code	Add to the part number for Type B or Deep only	Add to the part number for Type B only	
(Bore) Groove Diameter	Bore Diameter					Plastic	Rubber	Plastic	Rubber	Plastic	Rubber					
1.000	1.250	0.138	0.138	1.001	1.249	X	X			X		XXXX	12501000	-	125	B
1.000	1.250	0.138	0.172	1.001	1.249					X		XXXX	12501000	-	156	B
1.000	1.250	0.138	0.189	1.001	1.249			X				XXXX	12501000	-	172	B
1.000	1.250	0.138	0.206	1.001	1.249					X		XXXX	12501000	-	187	B
1.000	1.250	0.138	0.275	1.001	1.249			X	X	X	X	XXXX	12501000	-	250	B
1.000	1.312	0.172	0.172	1.001	1.311	X	X			X		XXXX	15601000	-	156	B
1.000	1.312	0.172	0.257	1.001	1.311					X		XXXX	15601000	-	234	B
1.000	1.375	0.206	0.275	1.001	1.374			X	X			XXXX	18701000	-	250	B
1.000	1.375	0.206	0.343	1.001	1.374	X	X	X	X	X	X	XXXX	18701000	-	312	B
1.000	1.500	0.275	0.275	1.001	1.499	X	X			X		XXXX	25001000	-	250	B
1.000	1.500	0.275	0.413	1.001	1.499			X	X	X	X	XXXX	25001000	-	375	B
1.000	1.625	0.343	0.550	1.002	1.623	X	X	X		X		XXXX	31201000	-	500	B
1.000	1.750	0.413	0.688	1.002	1.748	X	X	X				XXXX	37501000	-	625	B
1.000	1.875	0.481	0.688	1.002	1.873	X						XXXX	43701000	-	625	B
1.000	2.000	0.550	0.825	1.002	1.998	X						XXXX	50001000	-	750	B
1.000	2.000	0.550	0.825	1.002	1.998			X				XXXX	50001000	-	750	B
1.062	1.312	0.138	0.187	1.063	1.311	X	X			X		XXXX	12501062	-	170	B
1.062	1.312	0.138	0.275	1.063	1.311					X		XXXX	12501062	-	250	B
1.062	1.375	0.172	0.275	1.063	1.374	X						XXXX	15601062	-	250	B
1.062	1.436	0.206	0.343	1.063	1.435	X	X	X	X	X		XXXX	18701062	-	312	B
1.062	1.562	0.275	0.413	1.063	1.561	X						XXXX	25001062	-	375	B
1.062	1.687	0.343	0.550	1.064	1.685	X						XXXX	31201062	-	500	B
1.093	1.593	0.275	0.413	1.094	1.592	X						XXXX	25001093	-	375	B
1.125	1.375	0.138	0.129	1.126	1.374	X	X			X		XXXX	12501125	-	117	B
1.125	1.375	0.138	0.195	1.126	1.374					X		XXXX	12501125	-	177	B
1.125	1.375	0.138	0.275	1.126	1.374			X		X	X	XXXX	12501125	-	250	B
1.125	1.500	0.206	0.206	1.126	1.499	X	X			X		XXXX	18701125	-	187	B
1.125	1.500	0.206	0.343	1.126	1.499			X	X	X	X	XXXX	18701125	-	312	B
1.125	1.625	0.275	0.413	1.126	1.624	X	X	X	X	X	X	XXXX	25001125	-	375	B
1.125	1.750	0.343	0.550	1.127	1.748	X	X	X		X		XXXX	31201125	-	500	B
1.125	1.875	0.413	0.688	1.127	1.873	X	X					XXXX	37501125	-	625	B
1.125	2.000	0.481	0.550	1.127	1.998					X		XXXX	43701125	-	500	B
1.125	2.000	0.481	0.688	1.127	1.998	X						XXXX	43701250	-	625	B
1.187	1.437	0.138	0.196	1.188	1.436	X	X			X		XXXX	12501187	-	178	B
1.187	1.437	0.138	0.206	1.188	1.436			X				XXXX	12501187	-	187	B
1.187	1.437	0.138	0.275	1.188	1.436					X	X	XXXX	12501187	-	250	B
1.187	1.500	0.172	0.275	1.188	1.499	X	X					XXXX	15601187	-	250	B
1.187	1.562	0.206	0.343	1.188	1.561	X	X			X		XXXX	18701187	-	312	B
1.187	1.687	0.275	0.413	1.188	1.686	X					X	XXXX	25001187	-	375	B
1.187	1.812	0.343	0.550	1.189	1.810	X		X				XXXX	31201187	-	500	B
1.187	2.000	0.447	0.688	1.189	1.998	X						XXXX	40601187	-	625	B
1.250	1.500	0.138	0.206	1.251	1.499	X	X	X		X	X	XXXX	12501250	-	187	B

†For plastic compounds, see Table 3-1, page 3-11. For rubber compounds, see Table 3-3, page 3-14.

\*If used with wear rings, refer to wear ring throat diameter, see Section 9.

\*\*If used with wear rings, refer to wear ring piston diameter, see Section 9.

For custom groove calculations, see Appendix C.



**Standard, Deep and Type B PolyPak Profile**

**Table 6-8. Standard, Deep and Type B PolyPak Gland Dimensions — Inch (Continued)**

A Rod Diameter	B (Rod) Groove Diameter	C		D		Compound Codes (X = Standard Offering)†						Part Number				
		(Std. PP) Groove Width	(Deep & B) Groove Width	Throat Diameter*	Piston Diameter**	Standard PP		Deep PP		Type B		Compound Code	Energi-zer Code	Add to the part number for Type B or Deep only	Add to the part number for Type B only	
(Bore) Groove Diameter	Bore Diameter					Plastic	Rubber	Plastic	Rubber	Plastic	Rubber					
1.250	1.500	0.138	0.275	1.251	1.499				X	X	X	XXXX	12501250	-	250	B
1.250	1.563	0.172	0.275	1.251	1.562	X	X					XXXX	15601250	-	250	B
1.250	1.625	0.206	0.275	1.251	1.624	X	X			X		XXXX	18701250	-	250	B
1.250	1.625	0.206	0.343	1.251	1.624			X	X	X	X	XXXX	18701250	-	312	B
1.250	1.625	0.206	0.413	1.251	1.624					X		XXXX	18701250	-	375	B
1.250	1.750	0.275	0.275	1.251	1.749	X	X			X		XXXX	25001250	-	250	B
1.250	1.750	0.275	0.413	1.251	1.749			X	X	X	X	XXXX	25001250	-	375	B
1.250	1.875	0.343	0.550	1.252	1.873	X		X		X	X	XXXX	31201250	-	500	B
1.250	2.000	0.413	0.688	1.252	1.998	X	X	X		X		XXXX	37501250	-	625	B
1.250	2.063	0.447	0.688	1.252	2.061	X						XXXX	40601250	-	625	B
1.250	2.250	0.550	0.825	1.252	2.248	X						XXXX	50001250	-	750	B
1.250	2.500	0.688	0.963	1.253	2.497	X						XXXX	62501750	-	875	B
1.312	1.562	0.138	0.206	1.313	1.561	X	X			X		XXXX	12501312	-	187	B
1.312	1.625	0.172	0.275	1.313	1.624	X						XXXX	15601312	-	250	B
1.312	1.686	0.206	0.206	1.313	1.685	X	X			X		XXXX	18701312	-	187	B
1.312	1.686	0.206	0.343	1.313	1.685					X		XXXX	18701312	-	312	B
1.312	1.812	0.275	0.413	1.313	1.811	X	X	X		X		XXXX	25001312	-	375	B
1.312	1.937	0.343	0.550	1.314	1.935	X						XXXX	31201312	-	500	B
1.312	2.000	0.377	0.688	1.314	1.998	X						XXXX	34301312	-	625	B
1.312	2.062	0.413	0.481	1.314	2.060	X		X				XXXX	37501312	-	437	B
1.312	2.312	0.550	0.825	1.314	2.310	X						XXXX	50001312	-	750	B
1.375	1.625	0.138	0.138	1.376	1.624	X	X			X		XXXX	12501375	-	125	B
1.375	1.625	0.138	0.196	1.376	1.624					X		XXXX	12501375	-	178	B
1.375	1.625	0.138	0.275	1.376	1.624			X	X	X	X	XXXX	12501375	-	250	B
1.375	1.687	0.172	0.172	1.376	1.686	X	X			X		XXXX	15601375	-	156	B
1.375	1.750	0.206	0.343	1.376	1.749	X	X	X	X	X	X	XXXX	18701375	-	312	B
1.375	1.750	0.206	0.413	1.376	1.749					X		XXXX	18701375	-	375	B
1.375	1.875	0.275	0.413	1.376	1.874	X	X	X	X	X	X	XXXX	25001375	-	375	B
1.375	2.000	0.343	0.550	1.377	1.998	X	X	X	X	X	X	XXXX	31201375	-	500	B
1.375	2.125	0.413	0.688	1.377	2.123	X	X			X		XXXX	37501375	-	625	B
1.375	2.250	0.481	0.688	1.377	2.248	X						XXXX	43701375	-	625	B
1.375	2.375	0.550	0.825	1.377	2.373	X						XXXX	50001375	-	750	B
1.437	1.687	0.138	0.275	1.438	1.686	X	X	X	X	X		XXXX	12501437	-	250	B
1.437	1.812	0.206	0.343	1.438	1.811	X	X	X		X	X	XXXX	18701437	-	312	B
1.437	1.937	0.275	0.413	1.438	1.936		X					XXXX	25001437	-	375	B
1.437	2.061	0.343	0.550	1.439	2.059					X		XXXX	31201437	-	500	B
1.437	2.187	0.413	0.688	1.439	2.185	X						XXXX	37501437	-	625	B
1.437	2.312	0.481	0.688	1.439	2.310	X						XXXX	43701437	-	625	B
1.500	1.750	0.138	0.138	1.501	1.749	X	X			X		XXXX	12501500	-	125	B
1.500	1.750	0.138	0.206	1.501	1.749					X		XXXX	12501500	-	187	B
1.500	1.750	0.138	0.275	1.501	1.749			X		X	X	XXXX	12501500	-	250	B
1.500	1.750	0.138	0.343	1.501	1.749			X				XXXX	12501500	-	312	B

†For plastic compounds, see Table 3-1, page 3-11. For rubber compounds, see Table 3-3, page 3-14.

\*If used with wear rings, refer to wear ring throat diameter, see Section 9.

\*\*If used with wear rings, refer to wear ring piston diameter, see Section 9.

For custom groove calculations, see Appendix C.



Table 6-8. Standard, Deep and Type B PolyPak Gland Dimensions — Inch (Continued)

A Rod Diameter	B (Rod) Groove Diameter	C		D		Compound Codes (X = Standard Offering)†						Part Number				
		(Std. PP) Groove Width	(Deep & B) Groove Width	Throat Diameter*	Piston Diameter**	Standard PP		Deep PP		Type B		Compound Code	Energizer Code	Add to the part number for Type B or Deep only	Add to the part number for Type B only	
(Bore) Groove Diameter	Bore Diameter					Plastic	Rubber	Plastic	Rubber	Plastic	Rubber					
1.500	1.812	0.172	0.343	1.501	1.811	X				X		XXXX	15601500	-	312	B
1.500	1.875	0.206	0.206	1.501	1.874	X	X			X		XXXX	18701500	-	187	B
1.500	1.875	0.206	0.275	1.501	1.874			X		X	X	XXXX	18701500	-	250	B
1.500	1.875	0.206	0.309	1.501	1.874			X				XXXX	18701500	-	281	B
1.500	1.875	0.206	0.343	1.501	1.874					X		XXXX	18701500	-	312	B
1.500	1.875	0.206	0.413	1.501	1.874			X	X	X	X	XXXX	18701500	-	375	B
1.500	2.000	0.275	0.275	1.501	1.999	X	X			X		XXXX	25001500	-	250	B
1.500	2.000	0.275	0.413	1.501	1.999			X	X	X	X	XXXX	25001500	-	375	B
1.500	2.125	0.343	0.550	1.502	2.123	X	X	X		X	X	XXXX	31201500	-	500	B
1.500	2.250	0.413	0.688	1.502	2.248	X	X			X	X	XXXX	37501500	-	625	B
1.500	2.375	0.481	0.688	1.502	2.373	X						XXXX	43701500	-	625	B
1.500	2.500	0.550	0.825	1.502	2.498	X	X			X		XXXX	50001500	-	750	B
1.562	1.812	0.138	0.275	1.563	1.811	X						XXXX	12501562	-	250	B
1.562	1.937	0.206	0.275	1.563	1.936	X	X	X			X	XXXX	18701562	-	250	B
1.562	2.312	0.413	0.688	1.564	2.310	X						XXXX	37501562	-	625	B
1.625	1.875	0.138	0.275	1.626	1.874	X						XXXX	12501625	-	250	B
1.625	1.875	0.138	0.275	1.626	1.874			X				XXXX	12501625	-	250	B
1.625	2.000	0.206	0.206	1.626	1.999	X	X			X		XXXX	18701625	-	187	B
1.625	2.000	0.206	0.275	1.626	1.999			X				XXXX	18701625	-	250	B
1.625	2.000	0.206	0.293	1.626	1.999					X		XXXX	18701625	-	266	B
1.625	2.000	0.206	0.343	1.626	1.999			X		X		XXXX	18701625	-	312	B
1.625	2.000	0.206	0.413	1.626	1.999			X	X	X	X	XXXX	18701625	-	375	B
1.625	2.125	0.275	0.413	1.626	2.124	X	X			X	X	XXXX	25001625	-	375	B
1.625	2.250	0.343	0.550	1.627	2.248	X	X			X		XXXX	31201625	-	500	B
1.625	2.375	0.413	0.413	1.627	2.373	X	X			X		XXXX	37501625	-	375	B
1.625	2.375	0.413	0.688	1.627	2.373					X		XXXX	37501625	-	625	B
1.687	1.937	0.138	0.275	1.688	1.936	X						XXXX	12501687	-	250	B
1.687	2.062	0.206	0.413	1.688	2.061			X				XXXX	18701687	-	375	B
1.687	2.312	0.343	0.550	1.689	2.310	X				X		XXXX	31201687	-	500	B
1.750	2.000	0.138	0.138	1.751	1.999	X	X			X		XXXX	12501750	-	125	B
1.750	2.000	0.138	0.275	1.751	1.999			X				XXXX	12501750	-	250	B
1.750	2.125	0.206	0.206	1.751	2.124	X	X				X	XXXX	18701750	-	187	B
1.750	2.125	0.206	0.253	1.751	2.124			X		X		XXXX	18701750	-	230	B
1.750	2.125	0.206	0.275	1.751	2.124				X			XXXX	18701750	-	250	B
1.750	2.125	0.206	0.293	1.751	2.124					X	X	XXXX	18701750	-	266	B
1.750	2.125	0.206	0.343	1.751	2.124					X	X	XXXX	18701750	-	312	B
1.750	2.125	0.206	0.413	1.751	2.124			X	X	X	X	XXXX	18701750	-	375	B
1.750	2.188	0.240	0.413	1.751	2.187	X						XXXX	21801750	-	375	B
1.750	2.250	0.275	0.275	1.751	2.249	X	X			X		XXXX	25001750	-	250	B
1.750	2.250	0.275	0.413	1.751	2.249			X	X	X	X	XXXX	25001750	-	375	B
1.750	2.375	0.343	0.550	1.752	2.373	X	X	X	X	X	X	XXXX	31201750	-	500	B
1.750	2.500	0.413	0.688	1.752	2.498	X	X			X	X	XXXX	37501750	-	625	B

†For plastic compounds, see Table 3-1, page 3-11. For rubber compounds, see Table 3-3, page 3-14.

\*If used with wear rings, refer to wear ring throat diameter, see Section 9.

\*\*If used with wear rings, refer to wear ring piston diameter, see Section 9.

For custom groove calculations, see Appendix C.





**Standard, Deep and Type B PolyPak Profile**

**Table 6-8. Standard, Deep and Type B PolyPak Gland Dimensions — Inch (Continued)**

A Rod Diameter	B (Rod) Groove Diameter	C		D		Compound Codes (X = Standard Offering)†						Part Number				
		(Std. PP) Groove Width	(Deep & B) Groove Width	Throat Diameter*	Piston Diameter**	Standard PP		Deep PP		Type B		Compound Code	Energizer Code	Add to the part number for Type B or Deep only	Add to the part number for Type B only	
(Bore) Groove Diameter	Bore Diameter					Plastic	Rubber	Plastic	Rubber	Plastic	Rubber					
1.750	2.563	0.447	0.688	1.752	2.561	X						XXXX	40601750	-	625	B
1.750	2.625	0.481	0.688	1.752	2.623	X						XXXX	43701750	-	625	B
1.750	2.750	0.550	0.825	1.752	2.748			X				XXXX	50001750	-	750	B
1.750	3.000	0.688	0.963	1.753	2.997	X						XXXX	62501812	-	875	B
1.812	2.187	0.206	0.343	1.813	2.186	X						XXXX	18701812	-	312	B
1.812	2.500	0.377	0.688	1.814	2.498	X						XXXX	34301812	-	625	B
1.875	2.125	0.138	0.138	1.876	2.124	X	X				X	XXXX	12501875	-	125	B
1.875	2.125	0.138	0.275	1.876	2.124						X	XXXX	12501875	-	250	B
1.875	2.250	0.206	0.275	1.876	2.249				X			XXXX	18701875	-	250	B
1.875	2.250	0.206	0.308	1.876	2.249				X			XXXX	18701875	-	280	B
1.875	2.250	0.206	0.413	1.876	2.249	X	X	X	X	X	X	XXXX	18701875	-	375	B
1.875	2.375	0.275	0.413	1.876	2.374	X	X				X	XXXX	25001875	-	375	B
1.875	2.500	0.343	0.550	1.877	2.498	X	X	X			X	XXXX	31201875	-	500	B
1.875	2.625	0.413	0.688	1.877	2.623	X	X	X				XXXX	37501875	-	625	B
1.875	2.750	0.481	0.688	1.877	2.748	X						XXXX	43701875	-	625	B
1.875	2.875	0.550	0.825	1.877	2.873	X						XXXX	50001875	-	750	B
1.875	3.000	0.618	0.963	1.877	2.998			X				XXXX	56201875	-	875	B
1.875	3.125	0.688	1.100	1.878	3.122			X				XXXX	62501875	-	1000	B
1.937	2.312	0.206	0.309	1.938	2.311	X	X				X	XXXX	18701937	-	281	B
1.937	2.312	0.206	0.413	1.938	2.311			X				XXXX	18701937	-	375	B
1.937	2.437	0.275	0.413	1.938	2.436						X	XXXX	25001937	-	375	B
1.937	2.562	0.343	0.550	1.939	2.560	X						XXXX	31201937	-	500	B
2.000	2.250	0.138	0.206	2.001	2.249	X	X		X	X		XXXX	12502000	-	187	B
2.000	2.250	0.138	0.275	2.001	2.249			X				XXXX	12502000	-	250	B
2.000	2.375	0.206	0.206	2.001	2.374	X	X				X	XXXX	18702000	-	187	B
2.000	2.375	0.206	0.253	2.001	2.374						X	XXXX	18702000	-	230	B
2.000	2.375	0.206	0.289	2.001	2.374						X	XXXX	18702000	-	263	B
2.000	2.375	0.206	0.343	2.001	2.374						X	XXXX	18702000	-	312	B
2.000	2.375	0.206	0.413	2.001	2.374			X	X	X	X	XXXX	18702000	-	375	B
2.000	2.438	0.240	0.413	2.001	2.437			X				XXXX	21802000	-	375	B
2.000	2.500	0.275	0.275	2.001	2.499	X	X				X	XXXX	25002000	-	250	B
2.000	2.500	0.275	0.413	2.001	2.499			X	X	X	X	XXXX	25002000	-	375	B
2.000	2.625	0.343	0.550	2.002	2.623		X	X	X	X		XXXX	31202000	-	500	B
2.000	2.750	0.413	0.550	2.002	2.748			X				XXXX	37502000	-	500	B
2.000	2.750	0.413	0.688	2.002	2.748	X	X	X			X	XXXX	37502000	-	625	B
2.000	2.875	0.481	0.688	2.002	2.873	X						XXXX	43702000	-	625	B
2.000	3.000	0.550	0.825	2.002	2.998	X	X				X	XXXX	50002000	-	750	B
2.000	3.250	0.688	1.100	2.003	3.247	X						XXXX	62502000	-	1000	B
2.062	2.375	0.172	0.275	2.063	2.374	X						XXXX	15602062	-	250	B
2.062	2.437	0.206	0.413	2.063	2.436	X						XXXX	18702062	-	375	B
2.062	2.500	0.240	0.413	2.063	2.499	X						XXXX	21802062	-	375	B
2.062	2.812	0.413	0.688	2.064	2.810	X						XXXX	37502062	-	625	B

†For plastic compounds, see Table 3-1, page 3-11. For rubber compounds, see Table 3-3, page 3-14.

\*If used with wear rings, refer to wear ring throat diameter, see Section 9.

\*\*If used with wear rings, refer to wear ring piston diameter, see Section 9.

For custom groove calculations, see Appendix C.





Standard, Deep and Type B PolyPak Profile

Table 6-8. Standard, Deep and Type B PolyPak Gland Dimensions — Inch (Continued)

A Rod Diameter	B (Rod) Groove Diameter	C		D		Compound Codes (X = Standard Offering)†						Part Number				
		(Std. PP) Groove Width	(Deep & B) Groove Width	Throat Diameter*	Piston Diameter**	Standard PP		Deep PP		Type B		Compound Code	Energizer Code	Add to the part number for Type B or Deep only	Add to the part number for Type B only	
(Bore) Groove Diameter	Bore Diameter					Plastic	Rubber	Plastic	Rubber	Plastic	Rubber					
2.125	2.375	0.138	0.275	2.126	2.374	X				X		XXXX	12502125	-	250	B
2.125	2.500	0.206	0.206	2.126	2.499	X	X			X		XXXX	18702125	-	187	B
2.125	2.500	0.206	0.275	2.126	2.499			X		X		XXXX	18702125	-	250	B
2.125	2.500	0.206	0.413	2.126	2.499				X	X	X	XXXX	18702125	-	375	B
2.125	2.625	0.275	0.275	2.126	2.624	X	X			X		XXXX	25002125	-	250	B
2.125	2.625	0.275	0.413	2.126	2.624			X	X	X	X	XXXX	25002125	-	375	B
2.125	2.750	0.343	0.550	2.127	2.748	X	X	X	X	X	X	XXXX	31202125	-	500	B
2.125	2.875	0.413	0.688	2.127	2.873	X	X	X	X			XXXX	37502125	-	625	B
2.125	3.000	0.481	0.688	2.127	2.998	X						XXXX	43702125	-	625	B
2.125	3.125	0.550	0.825	2.127	3.123	X						XXXX	50002125	-	750	B
2.187	2.562	0.206	0.413	2.188	2.561			X	X			XXXX	18702187	-	375	B
2.250	2.500	0.138	0.206	2.251	2.499	X			X			XXXX	12502250	-	187	B
2.250	2.625	0.206	0.343	2.251	2.624				X			XXXX	18702250	-	312	B
2.250	2.625	0.206	0.413	2.251	2.624	X	X	X	X	X	X	XXXX	18702250	-	375	B
2.250	2.750	0.275	0.413	2.251	2.749	X	X	X	X	X	X	XXXX	25002250	-	375	B
2.250	2.812	0.309	0.413	2.251	2.811					X		XXXX	28102250	-	375	B
2.250	2.875	0.343	0.550	2.252	2.873	X	X			X	X	XXXX	31202250	-	500	B
2.250	3.000	0.413	0.688	2.252	2.998	X	X	X		X		XXXX	37502250	-	625	B
2.250	3.125	0.481	0.413	2.252	3.123			X				XXXX	43702250	-	375	B
2.250	3.125	0.481	0.688	2.252	3.123					X		XXXX	43702250	-	625	B
2.250	3.250	0.550	0.825	2.252	3.248	X						XXXX	50002250	-	750	B
2.312	2.875	0.309	0.550	2.313	2.874	X						XXXX	28102312	-	500	B
2.312	2.937	0.343	0.550	2.314	2.935	X						XXXX	31202312	-	500	B
2.312	3.000	0.377	0.688	2.314	2.998	X						XXXX	34302312	-	625	B
2.375	2.625	0.138	0.275	2.376	2.624	X	X	X				XXXX	12502375	-	250	B
2.375	2.750	0.206	0.275	2.376	2.749				X			XXXX	18702375	-	250	B
2.375	2.750	0.206	0.293	2.376	2.749	X	X			X		XXXX	18702375	-	266	B
2.375	2.750	0.206	0.343	2.376	2.749				X			XXXX	18702375	-	312	B
2.375	2.750	0.206	0.413	2.376	2.749			X		X	X	XXXX	18702375	-	375	B
2.375	2.875	0.275	0.275	2.376	2.874	X	X			X		XXXX	25002375	-	250	B
2.375	2.875	0.275	0.413	2.376	2.874				X	X	X	XXXX	25002375	-	375	B
2.375	3.000	0.343	0.550	2.377	2.998	X	X	X	X	X		XXXX	31202375	-	500	B
2.375	3.125	0.413	0.688	2.377	3.123	X	X			X	X	XXXX	37502375	-	625	B
2.375	3.375	0.550	0.825	2.377	3.373	X						XXXX	50002375	-	750	B
2.437	3.187	0.413	0.688	2.439	3.185	X						XXXX	37502437	-	625	B
2.500	2.750	0.138	0.275	2.501	2.749	X		X	X	X		XXXX	12502500	-	250	B
2.500	2.875	0.206	0.275	2.501	2.874	X	X		X	X	X	XXXX	18702500	-	250	B
2.500	2.875	0.206	0.413	2.501	2.874			X	X	X	X	XXXX	18702500	-	375	B
2.500	2.937	0.240	0.240	2.501	2.936	X	X				X	XXXX	21802500	-	218	B
2.500	2.937	0.240	0.320	2.501	2.936						X	XXXX	21802500	-	291	B
2.500	2.937	0.240	0.413	2.501	2.936						X	XXXX	21802500	-	375	B
2.500	3.000	0.275	0.275	2.501	2.999	X	X			X		XXXX	25002500	-	250	B

†For plastic compounds, see Table 3-1, page 3-11. For rubber compounds, see Table 3-3, page 3-14.

\*If used with wear rings, refer to wear ring throat diameter, see Section 9.

\*\*If used with wear rings, refer to wear ring piston diameter, see Section 9.

For custom groove calculations, see Appendix C.



**Standard, Deep and Type B PolyPak Profile**

**Table 6-8. Standard, Deep and Type B PolyPak Gland Dimensions — Inch (Continued)**

A Rod Diameter	B (Rod) Groove Diameter	C		D		Compound Codes (X = Standard Offering)†						Part Number				
		(Std. PP) Groove Width	(Deep & B) Groove Width	Throat Diameter*	Piston Diameter**	Standard PP		Deep PP		Type B		Compound Code	Energi-zer Code	Add to the part number for Type B or Deep only	Add to the part number for Type B only	
(Bore) Groove Diameter	Bore Diameter					Plastic	Rubber	Plastic	Rubber	Plastic	Rubber					
2.500	3.000	0.275	0.413	2.501	2.999			X	X	X	X	XXXX	25002500	-	375	B
2.500	3.125	0.343	0.550	2.502	3.123	X	X	X		X	X	XXXX	31202500	-	500	B
2.500	3.188	0.377	0.688	2.502	3.186	X						XXXX	34302500	-	625	B
2.500	3.250	0.413	0.688	2.502	3.248	X	X	X	X	X	X	XXXX	37502500	-	625	B
2.500	3.375	0.481	0.688	2.502	3.373	X				X		XXXX	43702500	-	625	B
2.500	3.500	0.550	0.825	2.502	3.498	X	X	X		X		XXXX	50002500	-	750	B
2.500	3.750	0.688	1.100	2.503	3.747	X						XXXX	62502500	-	1000	B
2.562	3.000	0.240	0.413	2.563	2.999	X	X					XXXX	21802562	-	375	B
2.562	3.062	0.275	0.413	2.563	3.061					X		XXXX	25002562	-	375	B
2.562	3.125	0.309	0.550	2.563	3.124	X						XXXX	28102562	-	500	B
2.562	3.187	0.343	0.550	2.564	3.185	X						XXXX	31202562	-	500	B
2.625	2.875	0.138	0.275	2.626	2.874	X						XXXX	12502625	-	250	B
2.625	3.000	0.206	0.309	2.626	2.999	X	X			X		XXXX	18702625	-	281	B
2.625	3.000	0.206	0.275	2.626	2.999				X			XXXX	18702625	-	250	B
2.625	3.000	0.206	0.343	2.626	2.999						X	XXXX	18702625	-	312	B
2.625	3.000	0.206	0.413	2.626	2.999			X	X	X		XXXX	18702625	-	375	B
2.625	3.125	0.275	0.413	2.626	3.124	X	X	X	X	X	X	XXXX	25002625	-	375	B
2.625	3.250	0.343	0.550	2.627	3.248	X	X	X	X	X	X	XXXX	31202625	-	500	B
2.625	3.375	0.413	0.688	2.627	3.373	X	X		X	X	X	XXXX	37502625	-	625	B
2.687	3.375	0.377	0.688	2.689	3.373	X						XXXX	34302687	-	625	B
2.687	3.437	0.413	0.688	2.689	3.435	X						XXXX	37502687	-	625	B
2.750	3.000	0.138	0.275	2.751	2.999	X	X			X		XXXX	12502750	-	250	B
2.750	3.125	0.206	0.206	2.751	3.124	X	X			X		XXXX	18702750	-	187	B
2.750	3.125	0.206	0.309	2.751	3.124					X		XXXX	18702750	-	281	B
2.750	3.125	0.206	0.413	2.751	3.124			X	X	X	X	XXXX	18702750	-	375	B
2.750	3.250	0.275	0.413	2.751	3.249	X	X	X	X	X	X	XXXX	25002750	-	375	B
2.750	3.375	0.343	0.550	2.752	3.373	X	X			X	X	XXXX	31202750	-	500	B
2.750	3.500	0.413	0.688	2.752	3.498	X	X	X	X	X	X	XXXX	37502750	-	625	B
2.750	3.750	0.550	0.825	2.752	3.748	X						XXXX	50002750	-	750	B
2.750	4.000	0.688	1.100	2.753	3.997	X		X		X		XXXX	62502750	-	1000	B
2.812	3.250	0.240	0.413	2.813	3.249	X	X					XXXX	21802812	-	375	B
2.812	4.062	0.688	1.100	2.815	4.059	X						XXXX	62502812	-	1000	B
2.875	3.125	0.138	0.275	2.876	3.124	X						XXXX	12502875	-	250	B
2.875	3.250	0.206	0.206	2.876	3.249	X	X				X	XXXX	18702875	-	187	B
2.875	3.250	0.206	0.275	2.876	3.249				X			XXXX	18702875	-	250	B
2.875	3.250	0.206	0.309	2.876	3.249					X		XXXX	18702875	-	281	B
2.875	3.250	0.206	0.413	2.876	3.249				X	X	X	XXXX	18702875	-	375	B
2.875	3.375	0.275	0.413	2.876	3.374	X	X		X	X	X	XXXX	25002875	-	375	B
2.875	3.500	0.343	0.550	2.877	3.498	X	X		X	X	X	XXXX	31202875	-	500	B
2.875	3.625	0.413	0.688	2.877	3.623	X	X		X	X		XXXX	37502875	-	625	B
2.875	3.750	0.481	0.688	2.877	3.748	X						XXXX	43702875	-	625	B
2.875	3.875	0.550	0.825	2.877	3.873	X						XXXX	50002875	-	750	B

†For plastic compounds, see Table 3-1, page 3-11. For rubber compounds, see Table 3-3, page 3-14.

\*If used with wear rings, refer to wear ring throat diameter, see Section 9.

\*\*If used with wear rings, refer to wear ring piston diameter, see Section 9.

For custom groove calculations, see Appendix C.



Table 6-8. Standard, Deep and Type B PolyPak Gland Dimensions — Inch (Continued)

A Rod Diameter	B (Rod) Groove Diameter	C		D		Compound Codes (X = Standard Offering)†						Part Number				
		(Std. PP) Groove Width	(Deep & B) Groove Width	Throat Diameter*	Piston Diameter**	Standard PP		Deep PP		Type B		Compound Code	Energizer Code	Add to the part number for Type B or Deep only	Add to the part number for Type B only	
(Bore) Groove Diameter	Bore Diameter					Plastic	Rubber	Plastic	Rubber	Plastic	Rubber					
2.875	4.000	0.618	0.963	2.877	3.998			X				XXXX	56202875	-	875	B
2.875	4.125	0.688	1.100	2.878	4.122					X		XXXX	62502875	-	1000	B
3.000	3.250	0.138	0.275	3.001	3.249	X		X				XXXX	12503000	-	250	B
3.000	3.375	0.206	0.275	3.001	3.374	X	X			X		XXXX	18703000	-	250	B
3.000	3.375	0.206	0.413	3.001	3.374			X	X	X	X	XXXX	18703000	-	375	B
3.000	3.437	0.240	0.240	3.001	3.436	X	X					XXXX	21803000	-	218	B
3.000	3.437	0.240	0.320	3.001	3.436						X	XXXX	21803000	-	291	B
3.000	3.437	0.240	0.343	3.001	3.436						X	XXXX	21803000	-	312	B
3.000	3.500	0.275	0.275	3.001	3.499	X	X			X		XXXX	25003000	-	250	B
3.000	3.500	0.275	0.413	3.001	3.499			X	X	X	X	XXXX	25003000	-	375	B
3.000	3.625	0.343	0.550	3.002	3.623	X	X	X	X	X	X	XXXX	31203000	-	500	B
3.000	3.750	0.413	0.550	3.002	3.748	X	X			X	X	XXXX	37503000	-	500	B
3.000	3.750	0.413	0.688	3.002	3.748	X		X	X	X	X	XXXX	37503000	-	625	B
3.000	3.875	0.481	0.756	3.002	3.873	X		X				XXXX	43703000	-	687	B
3.000	4.000	0.550	0.825	3.002	3.998	X		X		X	X	XXXX	50003000	-	750	B
3.000	4.250	0.688	1.100	3.003	4.247	X						XXXX	62503000	-	1000	B
3.062	3.500	0.240	0.413	3.063	3.499	X						XXXX	21803062	-	375	B
3.125	3.500	0.206	0.206	3.126	3.499	X	X			X		XXXX	18703125	-	187	B
3.125	3.500	0.206	0.343	3.126	3.499					X		XXXX	18703125	-	312	B
3.125	3.500	0.206	0.413	3.126	3.499			X	X	X	X	XXXX	18703125	-	375	B
3.125	3.625	0.275	0.413	3.126	3.624	X	X	X		X	X	XXXX	25003125	-	375	B
3.125	3.750	0.343	0.413	3.127	3.748	X	X				X	XXXX	31203125	-	375	B
3.125	3.750	0.343	0.550	3.127	3.748				X		X	XXXX	31203125	-	500	B
3.125	3.875	0.413	0.688	3.127	3.873	X				X		XXXX	37503125	-	625	B
3.125	4.000	0.481	0.688	3.127	3.998	X						XXXX	43703125	-	625	B
3.250	3.500	0.138	0.275	3.251	3.499	X						XXXX	12503250	-	250	B
3.250	3.625	0.206	0.275	3.251	3.624				X			XXXX	18703250	-	250	B
3.250	3.625	0.206	0.413	3.251	3.624	X	X	X		X	X	XXXX	18703250	-	375	B
3.250	3.750	0.275	0.275	3.251	3.749	X	X			X		XXXX	25003250	-	250	B
3.250	3.750	0.275	0.413	3.251	3.749			X	X	X	X	XXXX	25003250	-	375	B
3.250	3.875	0.343	0.550	3.252	3.873	X	X	X	X	X	X	XXXX	31203250	-	500	B
3.250	4.000	0.413	0.550	3.252	3.998	X	X				X	XXXX	37503250	-	500	B
3.250	4.000	0.413	0.688	3.252	3.998			X	X	X	X	XXXX	37503250	-	625	B
3.250	4.125	0.481	0.688	3.252	4.123	X						XXXX	43703250	-	625	B
3.250	4.250	0.550	0.825	3.252	4.248	X				X		XXXX	50003250	-	750	B
3.250	4.500	0.688	1.100	3.253	4.497	X				X		XXXX	62503250	-	1000	B
3.375	3.750	0.206	0.206	3.376	3.749	X				X		XXXX	18703375	-	187	B
3.375	3.750	0.206	0.275	3.376	3.749		X			X		XXXX	18703375	-	250	B
3.375	3.750	0.206	0.413	3.376	3.749			X		X	X	XXXX	18703375	-	375	B
3.375	3.875	0.275	0.413	3.376	3.874	X	X	X	X	X	X	XXXX	25003375	-	375	B
3.375	4.000	0.343	0.343	3.377	3.998	X	X			X		XXXX	31203375	-	312	B
3.375	4.000	0.343	0.550	3.377	3.998			X	X	X	X	XXXX	31203375	-	500	B

†For plastic compounds, see Table 3-1, page 3-11. For rubber compounds, see Table 3-3, page 3-14.

\*If used with wear rings, refer to wear ring throat diameter, see Section 9.

\*\*If used with wear rings, refer to wear ring piston diameter, see Section 9.

For custom groove calculations, see Appendix C.



**Standard, Deep and Type B PolyPak Profile**

**Table 6-8. Standard, Deep and Type B PolyPak Gland Dimensions — Inch (Continued)**

A	B	C		D		Compound Codes (X = Standard Offering)†						Part Number				
		(Std. PP) Groove Width	(Deep & B) Groove Width	Throat Diameter*	Piston Diameter**	Standard PP		Deep PP		Type B		Compound Code	Energizer Code	Add to the part number for Type B or Deep only	Add to the part number for Type B only	
(Rod) Groove Diameter	(Rod) Groove Diameter					Plastic	Rubber	Plastic	Rubber	Plastic	Rubber					
(Bore) Groove Diameter	Bore Diameter															
3.375	4.125	0.413	0.688	3.377	4.123	X				X		XXXX	37503375	-	625	B
3.375	4.375	0.550	0.688	3.377	4.373					X		XXXX	50003375	-	625	B
3.375	4.625	0.688	1.100	3.378	4.622	X						XXXX	62503375	-	1000	B
3.437	3.875	0.240	0.413	3.438	3.874	X						XXXX	21803437	-	375	B
3.500	3.750	0.138	0.275	3.501	3.749	X						XXXX	12503500	-	250	B
3.500	3.875	0.206	0.293	3.501	3.874	X	X			X		XXXX	18703500	-	266	B
3.500	3.875	0.206	0.309	3.501	3.874					X		XXXX	18703500	-	281	B
3.500	3.875	0.206	0.413	3.501	3.874			X	X	X	X	XXXX	18703500	-	375	B
3.500	4.000	0.275	0.275	3.501	3.999	X	X				X	XXXX	25003500	-	250	B
3.500	4.000	0.275	0.362	3.501	3.999						X	XXXX	25003500	-	329	B
3.500	4.000	0.275	0.413	3.501	3.999			X	X	X	X	XXXX	25003500	-	375	B
3.500	4.125	0.343	0.550	3.502	4.123	X	X	X		X	X	XXXX	31203500	-	500	B
3.500	4.250	0.413	0.688	3.502	4.248	X	X	X	X	X	X	XXXX	37503500	-	625	B
3.500	4.500	0.550	0.825	3.502	4.498	X	X	X		X	X	XXXX	50003500	-	750	B
3.500	4.750	0.688	1.100	3.503	4.747	X						XXXX	62503500	-	1000	B
3.500	5.000	0.825	1.375	3.503	4.997	X						XXXX	75003500	-	1250	B
3.625	3.875	0.138	0.206	3.626	3.874					X		XXXX	12503625	-	187	B
3.625	4.000	0.206	0.413	3.626	3.999	X	X	X		X	X	XXXX	18703625	-	375	B
3.625	4.125	0.275	0.413	3.626	4.124	X	X	X	X	X		XXXX	25003625	-	375	B
3.625	4.250	0.343	0.550	3.627	4.248	X	X		X	X	X	XXXX	31203625	-	500	B
3.625	4.375	0.413	0.688	3.627	4.373	X				X	X	XXXX	37503625	-	625	B
3.625	4.500	0.481	0.688	3.627	4.498	X						XXXX	43703625	-	625	B
3.625	4.625	0.550	0.825	3.627	4.623			X				XXXX	50003625	-	750	B
3.687	4.250	0.309	0.413	3.688	4.249			X				XXXX	28103687	-	375	B
3.750	4.125	0.206	0.275	3.751	4.124				X			XXXX	18703750	-	250	B
3.750	4.125	0.206	0.413	3.751	4.124	X	X	X		X	X	XXXX	18703750	-	375	B
3.750	4.250	0.275	0.413	3.751	4.249	X	X	X	X	X	X	XXXX	25003750	-	375	B
3.750	4.250	0.275	0.618	3.751	4.249					X		XXXX	25003750	-	562	B
3.750	4.375	0.343	0.413	3.752	4.373	X	X			X		XXXX	31203750	-	375	B
3.750	4.375	0.343	0.550	3.752	4.373					X	X	XXXX	31203750	-	500	B
3.750	4.375	0.343	0.688	3.752	4.373					X		XXXX	31203750	-	625	B
3.750	4.500	0.413	0.550	3.752	4.498				X			XXXX	37503750	-	500	B
3.750	4.500	0.413	0.688	3.752	4.498	X	X	X	X	X	X	XXXX	37503750	-	625	B
3.750	4.750	0.550	0.759	3.752	4.748	X	X	X		X		XXXX	50003750	-	690	B
3.750	5.000	0.688	1.100	3.753	4.997	X	X			X		XXXX	62503750	-	1000	B
3.875	4.250	0.206	0.413	3.876	4.249	X	X			X		XXXX	18703875	-	375	B
3.875	4.375	0.275	0.413	3.876	4.374	X	X	X			X	XXXX	25003875	-	375	B
3.875	4.500	0.343	0.550	3.877	4.498	X	X	X		X	X	XXXX	31203875	-	500	B
3.875	4.625	0.413	0.688	3.877	4.623	X	X			X	X	XXXX	37503875	-	625	B
3.875	4.750	0.481	0.825	3.877	4.748					X		XXXX	43703875	-	750	B
3.875	4.875	0.550	0.825	3.877	4.873					X	X	XXXX	50003875	-	750	B
3.937	4.500	0.309	0.550	3.938	4.499					X		XXXX	28103937	-	500	B

†For plastic compounds, see Table 3-1, page 3-11. For rubber compounds, see Table 3-3, page 3-14.

\*If used with wear rings, refer to wear ring throat diameter, see Section 9.

\*\*If used with wear rings, refer to wear ring piston diameter, see Section 9.

For custom groove calculations, see Appendix C.



Standard, Deep and Type B PolyPak Profile

Table 6-8. Standard, Deep and Type B PolyPak Gland Dimensions — Inch (Continued)

A Rod Diameter	B (Rod) Groove Diameter	C		D		Compound Codes (X = Standard Offering)†						Part Number				
		(Std. PP) Groove Width	(Deep & B) Groove Width	Throat Diameter*	Piston Diameter**	Standard PP		Deep PP		Type B		Compound Code	Energizer Code	Add to the part number for Type B or Deep only	Add to the part number for Type B only	
(Bore) Groove Diameter	Bore Diameter					Plastic	Rubber	Plastic	Rubber	Plastic	Rubber					
4.000	4.250	0.138	0.275	4.001	4.249	X						XXXX	12504000	-	250	B
4.000	4.375	0.206	0.206	4.001	4.374	X	X			X		XXXX	18704000	-	187	B
4.000	4.375	0.206	0.413	4.001	4.374			X		X	X	XXXX	18704000	-	375	B
4.000	4.500	0.275	0.275	4.001	4.499	X	X				X	XXXX	25004000	-	250	B
4.000	4.500	0.275	0.413	4.001	4.499			X	X	X	X	XXXX	25004000	-	375	B
4.000	4.500	0.275	0.618	4.001	4.499			X	X	X	X	XXXX	25004000	-	562	B
4.000	4.625	0.343	0.550	4.002	4.623			X				XXXX	31204000	-	500	B
4.000	4.625	0.343	0.618	4.002	4.623	X	X	X		X	X	XXXX	31204000	-	562	B
4.000	4.750	0.413	0.550	4.002	4.748	X	X				X	XXXX	37504000	-	500	B
4.000	4.750	0.413	0.688	4.002	4.748			X	X	X	X	XXXX	37504000	-	625	B
4.000	4.875	0.481	0.688	4.002	4.873	X	X	X		X		XXXX	43704000	-	625	B
4.000	4.875	0.481	0.825	4.002	4.873						X	XXXX	43704000	-	750	B
4.000	5.000	0.550	0.825	4.002	4.998	X	X	X		X	X	XXXX	50004000	-	750	B
4.000	5.250	0.688	1.100	4.003	5.247	X						XXXX	62504000	-	1000	B
4.000	5.500	0.825	1.375	4.003	5.497	X						XXXX	75004000	-	1250	B
4.062	4.562	0.275	0.413	4.063	4.561					X		XXXX	25004062	-	375	B
4.125	4.500	0.206	0.413	4.126	4.499	X	X	X	X	X	X	XXXX	18704125	-	375	B
4.125	4.625	0.275	0.618	4.126	4.624	X	X			X	X	XXXX	25004125	-	562	B
4.125	4.750	0.343	0.618	4.127	4.748	X		X	X	X		XXXX	31204125	-	562	B
4.125	4.875	0.413	0.688	4.127	4.873	X				X	X	XXXX	37504125	-	625	B
4.125	5.125	0.550	0.825	4.127	5.123	X				X		XXXX	50004125	-	750	B
4.125	5.250	0.618	0.963	4.127	5.248	X						XXXX	56204125	-	875	B
4.250	4.500	0.138	0.275	4.251	4.499	X						XXXX	12504250	-	250	B
4.250	4.625	0.206	0.275	4.251	4.624				X			XXXX	18704250	-	250	B
4.250	4.625	0.206	0.309	4.251	4.624	X	X			X		XXXX	18704250	-	281	B
4.250	4.625	0.206	0.413	4.251	4.624			X	X	X		XXXX	18704250	-	375	B
4.250	4.750	0.275	0.413	4.251	4.749	X	X		X	X	X	XXXX	25004250	-	375	B
4.250	4.750	0.275	0.618	4.251	4.749			X	X	X	X	XXXX	25004250	-	562	B
4.250	4.875	0.343	0.618	4.252	4.873	X	X	X		X	X	XXXX	31204250	-	562	B
4.250	5.000	0.413	0.413	4.252	4.998	X	X			X		XXXX	37504250	-	375	B
4.250	5.000	0.413	0.550	4.252	4.998			X	X			XXXX	37504250	-	500	B
4.250	5.000	0.413	0.688	4.252	4.998			X	X	X	X	XXXX	37504250	-	625	B
4.250	5.250	0.550	0.825	4.252	5.248	X				X		XXXX	50004250	-	750	B
4.250	5.500	0.688	1.100	4.253	5.497	X				X		XXXX	62504250	-	1000	B
4.250	5.750	0.825	1.375	4.253	5.747	X						XXXX	75004250	-	1250	B
4.312	5.312	0.550	0.825	4.314	5.310	X						XXXX	50004312	-	750	B
4.375	4.625	0.138	0.275	4.376	4.624	X						XXXX	12504375	-	250	B
4.375	4.750	0.206	0.413	4.376	4.749	X		X		X		XXXX	18704375	-	375	B
4.375	4.875	0.275	0.618	4.376	4.874	X	X	X	X		X	XXXX	25004375	-	562	B
4.375	5.000	0.343	0.343	4.377	4.998	X	X			X		XXXX	31204375	-	312	B
4.375	5.000	0.343	0.550	4.377	4.998			X	X			XXXX	31204375	-	500	B
4.375	5.000	0.343	0.618	4.377	4.998			X		X		XXXX	31204375	-	562	B

†For plastic compounds, see Table 3-1, page 3-11. For rubber compounds, see Table 3-3, page 3-14.

\*If used with wear rings, refer to wear ring throat diameter, see Section 9.

\*\*If used with wear rings, refer to wear ring piston diameter, see Section 9.

For custom groove calculations, see Appendix C.





**Standard, Deep and Type B PolyPak Profile**

**Table 6-8. Standard, Deep and Type B PolyPak Gland Dimensions — Inch (Continued)**

A Rod Diameter	B (Rod) Groove Diameter	C		D		Compound Codes (X = Standard Offering)†						Part Number				
		(Std. PP) Groove Width	(Deep & B) Groove Width	Throat Diameter*	Piston Diameter**	Standard PP		Deep PP		Type B		Compound Code	Energi-zer Code	Add to the part number for Type B or Deep only	Add to the part number for Type B only	
(Bore) Groove Diameter	Bore Diameter					Plastic	Rubber	Plastic	Rubber	Plastic	Rubber					
4.375	5.125	0.413	0.688	4.377	5.123	X	X	X		X	X	XXXX	37504375	-	625	B
4.375	5.375	0.550	0.688	4.377	5.373	X				X		XXXX	50004375	-	625	B
4.375	5.375	0.550	0.825	4.377	5.373			X		X		XXXX	50004375	-	750	B
4.397	5.147	0.413	0.688	4.399	5.145					X		XXXX	37504397	-	625	B
4.416	4.916	0.275	0.618	4.417	4.915					X		XXXX	25004416	-	562	B
4.437	4.937	0.275	0.413	4.438	4.936					X		XXXX	25004437	-	375	B
4.437	5.000	0.309	0.550	4.438	4.999	X						XXXX	28104437	-	500	B
4.500	4.750	0.138	0.206	4.501	4.749	X				X		XXXX	12504500	-	187	B
4.500	4.875	0.206	0.206	4.501	4.874	X				X		XXXX	18704500	-	187	B
4.500	4.875	0.206	0.413	4.501	4.874			X		X	X	XXXX	18704500	-	375	B
4.500	5.000	0.275	0.275	4.501	4.999	X	X			X	X	XXXX	25004500	-	250	B
4.500	5.000	0.275	0.413	4.501	4.999				X	X	X	XXXX	25004500	-	375	B
4.500	5.000	0.275	0.550	4.501	4.999					X	X	XXXX	25004500	-	500	B
4.500	5.000	0.275	0.618	4.501	4.999			X	X	X	X	XXXX	25004500	-	562	B
4.500	5.125	0.343	0.618	4.502	5.123	X	X			X		XXXX	31204500	-	562	B
4.500	5.125	0.343	0.688	4.502	5.123				X	X		XXXX	31204500	-	625	B
4.500	5.250	0.413	0.688	4.502	5.248	X	X	X	X	X	X	XXXX	37504500	-	625	B
4.500	5.375	0.481	0.825	4.502	5.373	X				X	X	XXXX	43704500	-	750	B
4.500	5.500	0.550	0.825	4.502	5.498	X	X	X		X	X	XXXX	50004500	-	750	B
4.500	5.750	0.688	1.100	4.503	5.747	X						XXXX	62504500	-	1000	B
4.500	6.000	0.825	1.375	4.503	5.997	X						XXXX	75004500	-	1250	B
4.625	5.000	0.206	0.413	4.626	4.999	X		X				XXXX	18704625	-	375	B
4.625	5.125	0.275	0.618	4.626	5.124	X	X			X	X	XXXX	25004625	-	562	B
4.625	5.250	0.343	0.688	4.627	5.248			X	X	X		XXXX	31204625	-	625	B
4.625	5.375	0.413	0.688	4.627	5.373	X				X	X	XXXX	37504625	-	625	B
4.625	5.875	0.688	1.100	4.628	5.872	X						XXXX	62504625	-	1000	B
4.687	5.250	0.309	0.688	4.688	5.249					X		XXXX	28104687	-	625	B
4.750	5.000	0.138	0.275	4.751	4.999	X						XXXX	12504750	-	250	B
4.750	5.125	0.206	0.413	4.751	5.124	X						XXXX	18704750	-	375	B
4.750	5.250	0.275	0.413	4.751	5.249	X	X			X		XXXX	25004750	-	375	B
4.750	5.250	0.275	0.618	4.751	5.249			X	X	X	X	XXXX	25004750	-	562	B
4.750	5.375	0.343	0.688	4.752	5.373	X			X	X		XXXX	31204750	-	625	B
4.750	5.500	0.413	0.550	4.752	5.498			X				XXXX	37504750	-	500	B
4.750	5.500	0.413	0.688	4.752	5.498	X	X	X	X	X	X	XXXX	37504750	-	625	B
4.750	5.625	0.481	0.688	4.752	5.623			X	X			XXXX	43704750	-	625	B
4.750	5.625	0.481	0.825	4.752	5.623	X	X			X		XXXX	43704750	-	750	B
4.750	5.750	0.550	0.756	4.752	5.748			X				XXXX	50004750	-	687	B
4.750	5.750	0.550	0.825	4.752	5.748	X				X		XXXX	50004750	-	750	B
4.750	6.000	0.688	1.100	4.753	5.997	X		X				XXXX	62504750	-	1000	B
4.750	6.250	0.825	1.375	4.753	6.247			X				XXXX	75004750	-	1250	B
4.875	5.250	0.206	0.413	4.876	5.249	X						XXXX	18704875	-	375	B
4.875	5.250	0.206	0.618	4.876	5.249			X				XXXX	18704875	-	562	B

†For plastic compounds, see Table 3-1, page 3-11. For rubber compounds, see Table 3-3, page 3-14.

\*If used with wear rings, refer to wear ring throat diameter, see Section 9.

\*\*If used with wear rings, refer to wear ring piston diameter, see Section 9.

For custom groove calculations, see Appendix C.





Table 6-8. Standard, Deep and Type B PolyPak Gland Dimensions — Inch (Continued)

A Rod Diameter	B (Rod) Groove Diameter	C		D		Compound Codes (X = Standard Offering)†						Part Number				
		(Std. PP) Groove Width	(Deep & B) Groove Width	Throat Diameter*	Piston Diameter**	Standard PP		Deep PP		Type B		Compound Code	Energizer Code	Add to the part number for Type B or Deep only	Add to the part number for Type B only	
(Bore) Groove Diameter	Bore Diameter					Plastic	Rubber	Plastic	Rubber	Plastic	Rubber					
4.875	5.375	0.275	0.413	4.876	5.374	X	X			X	X	XXXX	25004875	-	375	B
4.875	5.375	0.275	0.618	4.876	5.374			X	X	X	X	XXXX	25004875	-	562	B
4.875	5.500	0.343	0.343	4.877	5.498	X						XXXX	31204875	-	312	B
4.875	5.500	0.343	0.688	4.877	5.498						X	XXXX	31204875	-	625	B
4.875	5.625	0.413	0.688	4.877	5.623	X				X	X	XXXX	37504875	-	625	B
4.875	5.750	0.481	0.618	4.877	5.748					X		XXXX	43704875	-	562	B
4.875	5.875	0.550	0.618	4.877	5.873			X				XXXX	50004875	-	562	B
4.937	5.500	0.309	0.377	4.938	5.499					X		XXXX	28104937	-	343	B
4.937	5.500	0.309	0.550	4.938	5.499					X		XXXX	28104937	-	500	B
5.000	5.250	0.138	0.275	5.001	5.249	X						XXXX	12505000	-	250	B
5.000	5.375	0.206	0.309	5.001	5.374					X		XXXX	18705000	-	281	B
5.000	5.375	0.206	0.413	5.001	5.374			X			X	XXXX	18705000	-	375	B
5.000	5.500	0.275	0.413	5.001	5.499	X	X	X	X	X	X	XXXX	25005000	-	375	B
5.000	5.500	0.275	0.618	5.001	5.499			X	X	X	X	XXXX	25005000	-	562	B
5.000	5.562	0.309	0.381	5.001	5.561	X	X				X	XXXX	28105000	-	346	B
5.000	5.625	0.343	0.688	5.002	5.623	X	X			X	X	XXXX	31205000	-	625	B
5.000	5.750	0.413	0.413	5.002	5.748	X	X				X	XXXX	37505000	-	375	B
5.000	5.750	0.413	0.550	5.002	5.748					X		XXXX	37505000	-	500	B
5.000	5.750	0.413	0.688	5.002	5.748	X		X	X	X	X	XXXX	37505000	-	625	B
5.000	5.875	0.481	0.825	5.002	5.873					X	X	XXXX	43705000	-	750	B
5.000	6.000	0.550	0.825	5.002	5.998	X	X		X	X	X	XXXX	50005000	-	750	B
5.000	6.250	0.688	1.100	5.003	6.247	X				X		XXXX	62505000	-	1000	B
5.000	6.500	0.825	1.375	5.003	6.497	X						XXXX	75005000	-	1250	B
5.000	7.000	1.100	1.650	5.004	6.996			X				XXXX	100005000	-	1500	B
5.125	5.625	0.275	0.618	5.126	5.624	X	X		X			XXXX	25005125	-	562	B
5.125	5.750	0.343	0.688	5.127	5.748	X	X	X		X		XXXX	31205125	-	625	B
5.125	5.875	0.413	0.688	5.127	5.873	X				X		XXXX	37505125	-	625	B
5.125	6.000	0.481	0.550	5.127	5.998	X		X				XXXX	43705125	-	500	B
5.125	6.125	0.550	0.825	5.127	6.123	X		X				XXXX	50005125	-	750	B
5.250	5.625	0.206	0.413	5.251	5.624	X						XXXX	18705250	-	375	B
5.250	5.750	0.275	0.413	5.251	5.749	X	X	X		X		XXXX	25005250	-	375	B
5.250	5.750	0.275	0.618	5.251	5.749			X	X	X		XXXX	25005250	-	562	B
5.250	5.875	0.343	0.550	5.252	5.873	X	X				X	XXXX	31205250	-	500	B
5.250	5.875	0.343	0.688	5.252	5.873					X		XXXX	31205250	-	625	B
5.250	6.000	0.413	0.413	5.252	5.998	X	X			X		XXXX	37505250	-	375	B
5.250	6.000	0.413	0.550	5.252	5.998			X		X		XXXX	37505250	-	500	B
5.250	6.000	0.413	0.688	5.252	5.998			X	X	X	X	XXXX	37505250	-	625	B
5.250	6.250	0.550	0.550	5.252	6.248	X				X		XXXX	50005250	-	500	B
5.250	6.250	0.550	0.825	5.252	6.248					X		XXXX	50005250	-	750	B
5.250	6.500	0.688	1.100	5.253	6.497					X		XXXX	62505250	-	1000	B
5.375	5.875	0.275	0.413	5.376	5.874	X	X			X	X	XXXX	25005375	-	375	B
5.375	5.875	0.275	0.618	5.376	5.874					X		XXXX	25005375	-	562	B

†For plastic compounds, see Table 3-1, page 3-11. For rubber compounds, see Table 3-3, page 3-14.

\*If used with wear rings, refer to wear ring throat diameter, see Section 9.

\*\*If used with wear rings, refer to wear ring piston diameter, see Section 9.

For custom groove calculations, see Appendix C.



**Standard, Deep and Type B PolyPak Profile**

**Table 6-8. Standard, Deep and Type B PolyPak Gland Dimensions — Inch (Continued)**

A Rod Diameter	B (Rod) Groove Diameter	C		D		Compound Codes (X = Standard Offering)†						Part Number				
		(Std. PP) Groove Width	(Deep & B) Groove Width	Throat Diameter*	Piston Diameter**	Standard PP		Deep PP		Type B		Compound Code	Energizer Code	Add to the part number for Type B or Deep only	Add to the part number for Type B only	
(Bore) Groove Diameter	Bore Diameter					Plastic	Rubber	Plastic	Rubber	Plastic	Rubber					
5.375	6.000	0.343	0.688	5.377	5.998	X	X	X			X	XXXX	31205375	-	625	B
5.375	6.125	0.413	0.688	5.377	6.123	X				X	X	XXXX	37505375	-	625	B
5.375	6.375	0.550	0.825	5.377	6.373	X		X				XXXX	50005375	-	750	B
5.437	6.000	0.309	0.550	5.438	5.999	X	X					XXXX	28105437	-	500	B
5.437	6.437	0.550	0.825	5.439	6.435	X						XXXX	50005437	-	750	B
5.500	5.875	0.206	0.413	5.501	5.874					X		XXXX	18705500	-	375	B
5.500	6.000	0.275	0.413	5.501	5.999	X	X	X	X	X	X	XXXX	25005500	-	375	B
5.500	6.000	0.275	0.618	5.501	5.999			X		X	X	XXXX	25005500	-	562	B
5.500	6.125	0.343	0.343	5.502	6.123	X	X				X	XXXX	31205500	-	312	B
5.500	6.125	0.343	0.413	5.502	6.123						X	XXXX	31205500	-	374	B
5.500	6.125	0.343	0.550	5.502	6.123						X	XXXX	31205500	-	500	B
5.500	6.125	0.343	0.688	5.502	6.123			X		X		XXXX	31205500	-	625	B
5.500	6.250	0.413	0.688	5.502	6.248	X	X	X	X	X	X	XXXX	37505500	-	625	B
5.500	6.375	0.481	0.825	5.502	6.373	X						XXXX	43705500	-	750	B
5.500	6.500	0.550	0.825	5.502	6.498	X	X	X	X	X	X	XXXX	50005500	-	750	B
5.500	6.625	0.618	0.963	5.502	6.623	X						XXXX	56205500	-	875	B
5.500	6.750	0.688	1.100	5.503	6.747	X		X		X		XXXX	62505500	-	1000	B
5.500	7.000	0.825	1.375	5.503	6.997	X						XXXX	75005500	-	1250	B
5.625	6.125	0.275	0.618	5.626	6.124	X	X			X	X	XXXX	25005625	-	562	B
5.625	6.250	0.343	0.688	5.627	6.248				X	X		XXXX	31205625	-	625	B
5.625	6.375	0.413	0.688	5.627	6.373	X	X	X		X	X	XXXX	37505625	-	625	B
5.687	6.062	0.206	0.413	5.688	6.061	X						XXXX	18705687	-	375	B
5.750	6.000	0.138	0.275	5.751	5.999	X						XXXX	12505750	-	250	B
5.750	6.250	0.275	0.413	5.751	6.249	X	X				X	XXXX	25005750	-	375	B
5.750	6.250	0.275	0.618	5.751	6.249			X	X	X	X	XXXX	25005750	-	562	B
5.750	6.375	0.343	0.688	5.752	6.373					X		XXXX	31205750	-	625	B
5.750	6.500	0.413	0.550	5.752	6.498			X				XXXX	37505750	-	500	B
5.750	6.500	0.413	0.688	5.752	6.498	X		X		X	X	XXXX	37505750	-	625	B
5.750	6.750	0.550	0.825	5.752	6.748	X				X	X	XXXX	50005750	-	750	B
5.750	7.000	0.688	1.100	5.753	6.997	X	X					XXXX	62505750	-	1000	B
5.812	6.312	0.275	0.413	5.813	6.311				X			XXXX	25005812	-	375	B
5.875	6.250	0.206	0.413	5.876	6.249	X						XXXX	18705875	-	375	B
5.875	6.375	0.275	0.413	5.876	6.374	X					X	XXXX	25005875	-	375	B
5.875	6.375	0.275	0.618	5.876	6.374			X				XXXX	25005875	-	562	B
5.875	6.500	0.343	0.343	5.877	6.498	X					X	XXXX	31205875	-	312	B
5.875	6.500	0.343	0.688	5.877	6.498						X	XXXX	31205875	-	625	B
5.875	6.625	0.413	0.688	5.877	6.623	X	X			X		XXXX	37505875	-	625	B
5.937	6.500	0.309	0.550	5.938	6.499					X		XXXX	28105937	-	500	B
6.000	6.375	0.206	0.413	6.001	6.374	X		X				XXXX	18706000	-	375	B
6.000	6.500	0.275	0.413	6.001	6.499	X	X			X	X	XXXX	25006000	-	375	B
6.000	6.500	0.275	0.481	6.001	6.499					X		XXXX	25006000	-	437	B
6.000	6.500	0.275	0.618	6.001	6.499			X	X	X	X	XXXX	25006000	-	562	B

†For plastic compounds, see Table 3-1, page 3-11. For rubber compounds, see Table 3-3, page 3-14.

\*If used with wear rings, refer to wear ring throat diameter, see Section 9.

\*\*If used with wear rings, refer to wear ring piston diameter, see Section 9.

For custom groove calculations, see Appendix C.



Table 6-8. Standard, Deep and Type B PolyPak Gland Dimensions — Inch (Continued)

A Rod Diameter	B (Rod) Groove Diameter	C		D		Compound Codes (X = Standard Offering)†						Part Number				
		(Std. PP) Groove Width	(Deep & B) Groove Width	Throat Diameter*	Piston Diameter**	Standard PP		Deep PP		Type B		Compound Code	Energizer Code	Add to the part number for Type B or Deep only	Add to the part number for Type B only	
(Bore) Groove Diameter	Bore Diameter					Plastic	Rubber	Plastic	Rubber	Plastic	Rubber					
6.000	6.625	0.343	0.688	6.002	6.623	X				X		XXXX	31206000	-	625	B
6.000	6.750	0.413	0.550	6.002	6.748	X	X			X		XXXX	37506000	-	500	B
6.000	6.750	0.413	0.688	6.002	6.748			X	X	X	X	XXXX	37506000	-	625	B
6.000	7.000	0.550	0.825	6.002	6.998		X	X	X	X	X	XXXX	50006000	-	750	B
6.000	7.250	0.688	1.100	6.003	7.247	X					X	XXXX	62506000	-	1000	B
6.000	7.500	0.825	1.375	6.003	7.497	X						XXXX	75006000	-	1250	B
6.000	8.000	1.100	1.650	6.004	7.996	X						XXXX	10006000	-	1500	B
6.125	6.625	0.275	0.413	6.126	6.624	X						XXXX	25006125	-	375	B
6.125	6.750	0.343	0.688	6.127	6.748	X					X	XXXX	31206125	-	625	B
6.250	6.750	0.275	0.413	6.251	6.749	X	X				X	XXXX	25006250	-	375	B
6.250	6.750	0.275	0.618	6.251	6.749			X		X	X	XXXX	25006250	-	562	B
6.250	7.000	0.413	0.550	6.252	6.998	X	X	X		X		XXXX	37506250	-	500	B
6.250	7.000	0.413	0.688	6.252	6.998			X	X	X	X	XXXX	37506250	-	625	B
6.250	7.250	0.550	0.825	6.252	7.248	X	X			X	X	XXXX	50006250	-	750	B
6.250	7.500	0.688	1.100	6.253	7.497	X						XXXX	62506250	-	1000	B
6.250	7.750	0.825	1.375	6.253	7.747			X				XXXX	75006250	-	1250	B
6.312	6.687	0.206	0.413	6.313	6.686	X						XXXX	18706312	-	375	B
6.375	7.000	0.343	0.688	6.377	6.998	X	X	X		X	X	XXXX	31206375	-	625	B
6.375	7.375	0.550	0.825	6.377	7.373	X						XXXX	50006375	-	750	B
6.437	7.000	0.309	0.550	6.438	6.999	X	X					XXXX	28106437	-	500	B
6.500	7.000	0.275	0.413	6.501	6.999	X	X	X	X	X		XXXX	25006500	-	375	B
6.500	7.000	0.275	0.618	6.501	6.999			X	X	X	X	XXXX	25006500	-	562	B
6.500	7.125	0.343	0.688	6.502	7.123	X				X		XXXX	31206500	-	625	B
6.500	7.250	0.413	0.413	6.502	7.248	X	X				X	XXXX	37506500	-	375	B
6.500	7.250	0.413	0.550	6.502	7.248			X		X		XXXX	37506500	-	500	B
6.500	7.250	0.413	0.688	6.502	7.248			X		X	X	XXXX	37506500	-	625	B
6.500	7.500	0.550	0.825	6.502	7.498	X		X	X	X		XXXX	50006500	-	750	B
6.500	7.750	0.688	1.100	6.503	7.747	X		X				XXXX	62506500	-	1000	B
6.500	8.000	0.825	1.375	6.503	7.997	X		X				XXXX	75006500	-	1250	B
6.625	7.125	0.275	0.413	6.626	7.124			X	X			XXXX	25006625	-	375	B
6.625	7.250	0.343	0.688	6.627	7.248	X				X		XXXX	31206625	-	625	B
6.625	7.875	0.688	1.100	6.628	7.872	X						XXXX	62506625	-	1000	B
6.750	7.250	0.275	0.413	6.751	7.249	X	X			X	X	XXXX	25006750	-	375	B
6.750	7.250	0.275	0.618	6.751	7.249			X		X	X	XXXX	25006750	-	562	B
6.750	7.375	0.343	0.688	6.752	7.373	X				X		XXXX	31206750	-	625	B
6.750	7.500	0.413	0.413	6.752	7.498	X	X			X		XXXX	37506750	-	375	B
6.750	7.500	0.413	0.550	6.752	7.498					X		XXXX	37506750	-	500	B
6.750	7.500	0.413	0.618	6.752	7.498			X				XXXX	37506750	-	562	B
6.750	7.500	0.413	0.688	6.752	7.498			X		X	X	XXXX	37506750	-	625	B
6.750	7.750	0.550	0.825	6.752	7.748	X			X	X		XXXX	50006750	-	750	B
6.750	7.875	0.618	0.963	6.752	7.873	X						XXXX	56206750	-	875	B
6.750	8.000	0.688	1.100	6.753	7.997	X		X		X		XXXX	62506750	-	1000	B



†For plastic compounds, see Table 3-1, page 3-11. For rubber compounds, see Table 3-3, page 3-14.

\*If used with wear rings, refer to wear ring throat diameter, see Section 9.

\*\*If used with wear rings, refer to wear ring piston diameter, see Section 9.

For custom groove calculations, see Appendix C.



**Standard, Deep and Type B PolyPak Profile**

**Table 6-8. Standard, Deep and Type B PolyPak Gland Dimensions — Inch (Continued)**

A Rod Diameter	B (Rod) Groove Diameter	C		D		Compound Codes (X = Standard Offering)†						Part Number				
		(Std. PP) Groove Width	(Deep & B) Groove Width	Throat Diameter*	Piston Diameter**	Standard PP		Deep PP		Type B		Compound Code	Energi-zer Code	Add to the part number for Type B or Deep only	Add to the part number for Type B only	
(Bore) Groove Diameter	Bore Diameter					Plastic	Rubber	Plastic	Rubber	Plastic	Rubber					
6.875	7.625	0.413	0.688	6.877	7.623					X		XXXX	37506875	-	625	B
6.875	8.125	0.688	1.100	6.878	8.122	X						XXXX	62506875	-	1000	B
6.937	7.500	0.309	0.550	6.938	7.499					X		XXXX	28106937	-	500	B
7.000	7.375	0.206	0.413	7.001	7.374					X		XXXX	18707000	-	375	B
7.000	7.500	0.275	0.413	7.001	7.499	X	X	X		X	X	XXXX	25007000	-	375	B
7.000	7.500	0.275	0.618	7.001	7.499			X	X	X	X	XXXX	25007000	-	562	B
7.000	7.625	0.343	0.688	7.002	7.623	X				X		XXXX	31207000	-	625	B
7.000	7.750	0.413	0.550	7.002	7.748	X	X			X		XXXX	37507000	-	500	B
7.000	7.750	0.413	0.688	7.002	7.748			X		X	X	XXXX	37507000	-	625	B
7.000	8.000	0.550	0.825	7.002	7.998	X	X	X	X	X	X	XXXX	50007000	-	750	B
7.000	8.250	0.688	1.100	7.003	8.247	X				X		XXXX	62507000	-	1000	B
7.000	8.500	0.825	1.375	7.003	8.497	X	X	X				XXXX	75007000	-	1250	B
7.000	9.000	1.100	1.650	7.004	8.996	X						XXXX	100007000	-	1500	B
7.125	7.625	0.275	0.413	7.126	7.624	X			X			XXXX	25007125	-	375	B
7.187	8.000	0.447	0.688	7.189	7.998	X						XXXX	40607187	-	625	B
7.250	7.750	0.275	0.618	7.251	7.749	X	X			X	X	XXXX	25007250	-	562	B
7.250	7.875	0.343	0.688	7.252	7.873	X				X		XXXX	31207250	-	625	B
7.250	8.000	0.413	0.688	7.252	7.998	X	X	X	X	X	X	XXXX	37507250	-	625	B
7.250	8.250	0.550	0.825	7.252	8.248				X	X	X	XXXX	50007250	-	750	B
7.250	8.500	0.688	1.100	7.253	8.497					X		XXXX	62507250	-	1000	B
7.375	7.750	0.206	0.413	7.376	7.749		X					XXXX	18707375	-	375	B
7.375	8.000	0.343	0.688	7.377	7.998	X	X					XXXX	31207375	-	625	B
7.375	8.125	0.413	0.550	7.377	8.123					X		XXXX	37507375	-	500	B
7.404	8.028	0.343	0.688	7.406	8.026					X		XXXX	31207404	-	625	B
7.500	7.875	0.206	0.275	7.501	7.874			X				XXXX	18707500	-	250	B
7.500	8.000	0.275	0.618	7.501	7.999	X	X	X	X	X	X	XXXX	25007500	-	562	B
7.500	8.125	0.343	0.688	7.502	8.123	X		X				XXXX	31207500	-	625	B
7.500	8.250	0.413	0.550	7.502	8.248	X	X	X		X		XXXX	37507500	-	500	B
7.500	8.250	0.413	0.688	7.502	8.248	X		X	X	X	X	XXXX	37507500	-	625	B
7.500	8.500	0.550	0.825	7.502	8.498	X		X		X		XXXX	50007500	-	750	B
7.500	8.750	0.688	1.100	7.503	8.747					X		XXXX	62507500	-	1000	B
7.500	9.000	0.825	1.375	7.503	8.997	X		X				XXXX	75007500	-	1250	B
7.500	9.500	1.100	1.650	7.504	9.496	X						XXXX	100007500	-	1500	B
7.625	8.250	0.343	0.550	7.627	8.248			X				XXXX	31207625	-	500	B
7.625	8.375	0.413	0.688	7.627	8.373	X						XXXX	37507625	-	625	B
7.750	8.250	0.275	0.618	7.751	8.249	X	X	X		X		XXXX	25007750	-	562	B
7.750	8.375	0.343	0.688	7.752	8.373	X						XXXX	31207750	-	625	B
7.750	8.500	0.413	0.550	7.752	8.498	X	X	X		X		XXXX	37507750	-	500	B
7.750	8.500	0.413	0.688	7.752	8.498			X	X	X	X	XXXX	37507750	-	625	B
7.750	8.750	0.550	0.825	7.752	8.748	X				X		XXXX	50007750	-	750	B
7.750	9.000	0.688	1.100	7.753	8.997	X				X		XXXX	62507750	-	1000	B
7.790	8.540	0.413	0.413	7.792	8.538					X		XXXX	37507790	-	375	B

†For plastic compounds, see Table 3-1, page 3-11. For rubber compounds, see Table 3-3, page 3-14.

\*If used with wear rings, refer to wear ring throat diameter, see Section 9.

\*\*If used with wear rings, refer to wear ring piston diameter, see Section 9.

For custom groove calculations, see Appendix C.



Table 6-8. Standard, Deep and Type B PolyPak Gland Dimensions — Inch (Continued)

A Rod Diameter	B (Rod) Groove Diameter	C		D		Compound Codes (X = Standard Offering)†						Part Number				
		(Std. PP) Groove Width	(Deep & B) Groove Width	Throat Diameter*	Piston Diameter**	Standard PP		Deep PP		Type B		Compound Code	Energizer Code	Add to the part number for Type B or Deep only	Add to the part number for Type B only	
(Bore) Groove Diameter	Bore Diameter					Plastic	Rubber	Plastic	Rubber	Plastic	Rubber					
7.875	8.500	0.343	0.688	7.877	8.498	X				X		XXXX	31207875	-	625	B
7.875	8.625	0.413	0.688	7.877	8.623						X	XXXX	37507875	-	625	B
7.875	8.875	0.550	0.825	7.877	8.873					X		XXXX	50007875	-	750	B
8.000	8.500	0.275	0.618	8.001	8.499	X	X			X	X	XXXX	25008000	-	562	B
8.000	8.625	0.343	0.688	8.002	8.623	X	X			X		XXXX	31208000	-	625	B
8.000	8.750	0.413	0.550	8.002	8.748			X				XXXX	37508000	-	500	B
8.000	8.750	0.413	0.688	8.002	8.748	X	X	X		X	X	XXXX	37508000	-	625	B
8.000	9.000	0.550	0.825	8.002	8.998	X		X	X	X	X	XXXX	50008000	-	750	B
8.000	9.250	0.688	1.100	8.003	9.247	X		X				XXXX	62508000	-	1000	B
8.000	9.500	0.825	1.238	8.003	9.497	X				X		XXXX	75008000	-	1125	B
8.000	9.500	0.825	1.375	8.003	9.497					X		XXXX	75008000	-	1250	B
8.000	10.000	1.100	1.650	8.004	9.996	X						XXXX	100008000	-	1500	B
8.125	8.625	0.275	0.618	8.126	8.624					X		XXXX	25008125	-	562	B
8.187	9.437	0.688	1.100	8.190	9.434	X						XXXX	62508187	-	1000	B
8.250	8.750	0.275	0.413	8.251	8.749	X	X			X		XXXX	25008250	-	375	B
8.250	8.750	0.275	0.618	8.251	8.749					X	X	XXXX	25008250	-	562	B
8.250	9.000	0.413	0.688	8.252	8.998	X	X	X	X	X	X	XXXX	37508250	-	625	B
8.250	9.250	0.550	0.825	8.252	9.248	X		X		X		XXXX	50008250	-	750	B
8.250	9.500	0.688	1.100	8.253	9.497	X				X		XXXX	62508250	-	1000	B
8.250	9.750	0.825	1.375	8.253	9.747	X						XXXX	75008250	-	1250	B
8.375	9.000	0.343	0.688	8.377	8.998	X		X				XXXX	31208375	-	625	B
8.375	9.875	0.825	1.375	8.378	9.872	X						XXXX	75008375	-	1250	B
8.500	9.000	0.275	0.618	8.501	8.999	X	X	X		X	X	XXXX	25008500	-	562	B
8.500	9.125	0.343	0.688	8.502	9.123	X						XXXX	31208500	-	625	B
8.500	9.250	0.413	0.688	8.502	9.248	X	X			X	X	XXXX	37508500	-	625	B
8.500	9.500	0.550	0.825	8.502	9.498	X	X	X		X	X	XXXX	50008500	-	750	B
8.500	9.750	0.688	1.100	8.503	9.747	X				X		XXXX	62508500	-	1000	B
8.500	10.000	0.825	1.238	8.503	9.997	X	X			X		XXXX	75008500	-	1125	B
8.500	10.000	0.825	1.375	8.503	9.997			X				XXXX	75008500	-	1250	B
8.500	10.250	0.963	1.513	8.504	10.246	X						XXXX	87508500	-	1375	B
8.625	9.375	0.413	0.688	8.627	9.373	X						XXXX	37508625	-	625	B
8.625	9.875	0.688	1.100	8.628	9.872	X						XXXX	62508625	-	1000	B
8.750	9.250	0.275	0.618	8.751	9.249	X	X	X				XXXX	25008750	-	562	B
8.750	9.500	0.413	0.413	8.752	9.498	X	X				X	XXXX	37508750	-	375	B
8.750	9.500	0.413	0.550	8.752	9.498	X				X		XXXX	37508750	-	500	B
8.750	9.500	0.413	0.688	8.752	9.498			X	X			XXXX	37508750	-	625	B
8.750	9.500	0.413	0.825	8.752	9.498			X		X		XXXX	37508750	-	750	B
8.750	9.750	0.550	0.825	8.752	9.748	X		X		X		XXXX	50008750	-	750	B
8.750	10.000	0.688	1.100	8.753	9.997	X		X				XXXX	62508750	-	1000	B
8.795	9.545	0.413	0.413	8.797	9.543					X		XXXX	37508795	-	375	B
8.875	9.500	0.343	0.688	8.877	9.498	X						XXXX	31208875	-	625	B
8.875	9.625	0.413	0.688	8.877	9.623					X	X	XXXX	37508875	-	625	B

†For plastic compounds, see Table 3-1, page 3-11. For rubber compounds, see Table 3-3, page 3-14.

\*If used with wear rings, refer to wear ring throat diameter, see Section 9.

\*\*If used with wear rings, refer to wear ring piston diameter, see Section 9.

For custom groove calculations, see Appendix C.





**Standard, Deep and Type B PolyPak Profile**

**Table 6-8. Standard, Deep and Type B PolyPak Gland Dimensions — Inch (Continued)**

A	B	C		D		Compound Codes (X = Standard Offering)†						Part Number				
		(Std. PP) Groove Width	(Deep & B) Groove Width	Throat Diameter*	Piston Diameter**	Standard PP		Deep PP		Type B		Compound Code	Energizer Code	Add to the part number for Type B or Deep only	Add to the part number for Type B only	
(Rod) Groove Diameter	(Bore) Groove Diameter					Plastic	Rubber	Plastic	Rubber	Plastic	Rubber					
8.937	9.500	0.309	0.550	8.938	9.499					X		XXXX	28108937	-	500	B
9.000	9.500	0.275	0.413	9.001	9.499	X	X	X		X		XXXX	25009000	-	375	B
9.000	9.625	0.343	0.550	9.002	9.623			X				XXXX	31209000	-	500	B
9.000	9.750	0.413	0.688	9.002	9.748	X	X	X		X	X	XXXX	37509000	-	625	B
9.000	10.000	0.550	0.825	9.002	9.998	X	X	X	X	X	X	XXXX	50009000	-	750	B
9.000	10.250	0.688	1.100	9.003	10.247	X		X		X		XXXX	62509000	-	1000	B
9.000	10.500	0.825	1.375	9.003	10.497	X		X				XXXX	75009000	-	1250	B
9.125	9.750	0.343	0.688	9.127	9.748					X		XXXX	31209125	-	625	B
9.250	9.750	0.275	0.618	9.251	9.749	X	X	X				XXXX	25009250	-	562	B
9.250	9.875	0.343	0.688	9.252	9.873					X		XXXX	31209250	-	625	B
9.250	10.000	0.413	0.550	9.252	9.998			X				XXXX	37509250	-	500	B
9.250	10.000	0.413	0.688	9.252	9.998	X	X	X	X	X		XXXX	37509250	-	625	B
9.250	10.250	0.550	0.825	9.252	10.248					X		XXXX	50009250	-	750	B
9.250	10.500	0.688	1.100	9.253	10.497	X						XXXX	62509250	-	1000	B
9.312	10.000	0.377	0.688	9.314	9.998	X	X					XXXX	34309312	-	625	B
9.375	10.000	0.343	0.688	9.377	9.998					X		XXXX	31209375	-	625	B
9.500	10.000	0.275	0.413	9.501	9.999			X				XXXX	25009500	-	375	B
9.500	10.000	0.275	0.618	9.501	9.999		X	X	X	X		XXXX	25009500	-	562	B
9.500	10.125	0.343	0.688	9.502	10.123	X						XXXX	31209500	-	625	B
9.500	10.250	0.413	0.688	9.502	10.248	X				X	X	XXXX	37509500	-	625	B
9.500	10.500	0.550	0.825	9.502	10.498	X	X	X		X		XXXX	50009500	-	750	B
9.500	11.000	0.825	1.375	9.503	10.997	X						XXXX	75009500	-	1250	B
9.500	11.500	1.100	1.650	9.504	11.496	X						XXXX	100009500	-	1500	B
9.625	10.250	0.343	0.688	9.627	10.248	X				X		XXXX	31209625	-	625	B
9.625	10.375	0.413	0.688	9.627	10.373			X			X	XXXX	37509625	-	625	B
9.625	11.500	1.031	1.650	9.629	11.496			X				XXXX	93709625	-	1500	B
9.750	10.250	0.275	0.413	9.751	10.249	X	X			X		XXXX	25009750	-	375	B
9.750	10.250	0.275	0.618	9.751	10.249					X		XXXX	25009750	-	562	B
9.750	10.375	0.343	0.688	9.752	10.373					X		XXXX	31209750	-	625	B
9.750	10.500	0.413	0.688	9.752	10.498	X		X				XXXX	37509750	-	625	B
9.750	10.750	0.550	0.825	9.752	10.748	X				X		XXXX	50009750	-	750	B
9.750	11.250	0.825	1.375	9.753	11.247					X		XXXX	75009750	-	1250	B
9.750	11.500	0.963	1.513	9.754	11.496	X						XXXX	87509750	-	1375	B
9.812	11.312	0.825	1.375	9.815	11.309			X				XXXX	75009812	-	1250	B
9.875	10.625	0.413	0.688	9.877	10.623	X					X	XXXX	37509875	-	625	B
9.875	10.875	0.550	0.825	9.877	10.873			X				XXXX	50009875	-	750	B
10.000	10.500	0.275	0.618	10.001	10.499	X	X			X	X	XXXX	25010000	-	562	B
10.000	10.625	0.343	0.688	10.002	10.623	X						XXXX	31210000	-	625	B
10.000	10.750	0.413	0.688	10.002	10.748	X	X			X	X	XXXX	37510000	-	625	B
10.000	11.000	0.550	0.825	10.002	10.998	X	X	X	X	X	X	XXXX	50010000	-	750	B
10.000	11.250	0.688	1.100	10.003	11.247	X		X				XXXX	62510000	-	1000	B
10.000	11.500	0.825	1.375	10.003	11.497	X				X		XXXX	75010000	-	1250	B

†For plastic compounds, see Table 3-1, page 3-11. For rubber compounds, see Table 3-3, page 3-14.

\*If used with wear rings, refer to wear ring throat diameter, see Section 9.

\*\*If used with wear rings, refer to wear ring piston diameter, see Section 9.

For custom groove calculations, see Appendix C.





Table 6-8. Standard, Deep and Type B PolyPak Gland Dimensions — Inch (Continued)

A Rod Diameter	B (Rod) Groove Diameter	C		D		Compound Codes (X = Standard Offering)†						Part Number				
		(Std. PP) Groove Width	(Deep & B) Groove Width	Throat Diameter*	Piston Diameter**	Standard PP		Deep PP		Type B		Compound Code	Energizer Code	Add to the part number for Type B or Deep only	Add to the part number for Type B only	
(Bore) Groove Diameter	Bore Diameter					Plastic	Rubber	Plastic	Rubber	Plastic	Rubber					
10.000	12.000	1.100	1.650	10.004	11.996	X						XXXX	100010000	-	1500	B
10.125	10.750	0.343	0.688	10.127	10.748	X						XXXX	31210125	-	625	B
10.125	10.875	0.413	0.688	10.127	10.873						X	XXXX	37510125	-	625	B
10.187	11.000	0.447	0.550	10.189	10.998			X				XXXX	40610187	-	500	B
10.250	10.750	0.275	0.618	10.251	10.749	X	X			X	X	XXXX	25010250	-	562	B
10.250	11.000	0.413	0.550	10.252	10.998	X	X			X		XXXX	37510250	-	500	B
10.250	11.000	0.413	0.688	10.252	10.998			X				XXXX	37510250	-	625	B
10.250	11.000	0.413	0.825	10.252	10.998					X		XXXX	37510250	-	750	B
10.250	11.250	0.550	0.825	10.252	11.248					X		XXXX	50010250	-	750	B
10.250	11.500	0.688	1.100	10.253	11.497	X						XXXX	62510250	-	1000	B
10.375	11.000	0.343	0.688	10.377	10.998					X		XXXX	31210375	-	625	B
10.500	11.000	0.275	0.550	10.501	10.999			X				XXXX	25010500	-	500	B
10.500	11.000	0.275	0.618	10.501	10.999	X				X		XXXX	25010500	-	562	B
10.500	11.125	0.343	0.550	10.502	11.123			X				XXXX	31210500	-	500	B
10.500	11.250	0.413	0.413	10.502	11.248	X				X		XXXX	37510500	-	375	B
10.500	11.250	0.413	0.688	10.502	11.248			X		X		XXXX	37510500	-	625	B
10.500	11.500	0.550	0.825	10.502	11.498	X		X		X		XXXX	50010500	-	750	B
10.500	11.750	0.688	0.825	10.503	11.747	X				X		XXXX	62510500	-	750	B
10.500	12.000	0.825	1.100	10.503	11.997	X	X			X		XXXX	75010500	-	1000	B
10.500	12.000	0.825	1.375	10.503	11.997			X				XXXX	75010500	-	1250	B
10.500	12.000	0.825	1.375	10.503	11.997	X						XXXX	75010750	-	1250	B
10.625	11.625	0.550	0.688	10.627	11.623				X			XXXX	50010625	-	625	B
10.625	11.625	0.550	0.825	10.627	11.623			X				XXXX	50010625	-	750	B
10.750	11.250	0.275	0.413	10.751	11.249	X	X					XXXX	25010750	-	375	B
10.750	11.500	0.413	0.688	10.752	11.498	X	X	X		X		XXXX	37510750	-	625	B
10.750	11.750	0.550	0.825	10.752	11.748	X		X		X		XXXX	50010750	-	750	B
11.000	11.500	0.275	0.618	11.001	11.499	X				X		XXXX	25011000	-	562	B
11.000	11.750	0.413	0.688	11.002	11.748	X						XXXX	37511000	-	625	B
11.000	12.000	0.550	0.825	11.002	11.998	X	X	X		X	X	XXXX	50011000	-	750	B
11.000	12.250	0.688	1.100	11.003	12.247	X		X		X		XXXX	62511000	-	1000	B
11.000	12.500	0.825	1.375	11.003	12.497	X		X				XXXX	75011000	-	1250	B
11.125	11.750	0.343	0.688	11.127	11.748						X	XXXX	31211125	-	625	B
11.250	11.750	0.275	0.413	11.251	11.749	X				X		XXXX	25011250	-	375	B
11.250	11.750	0.275	0.618	11.251	11.749					X		XXXX	25011250	-	562	B
11.250	12.000	0.413	0.688	11.252	11.998	X	X	X	X	X		XXXX	37511250	-	625	B
11.250	12.250	0.550	0.825	11.252	12.248	X				X		XXXX	50011250	-	750	B
11.250	12.500	0.688	1.100	11.253	12.497					X		XXXX	62511250	-	1000	B
11.375	12.375	0.550	0.825	11.377	12.373	X				X		XXXX	50011375	-	750	B
11.500	12.000	0.275	0.618	11.501	11.999	X	X			X		XXXX	25011500	-	562	B
11.500	12.250	0.413	0.688	11.502	12.248	X		X		X	X	XXXX	37511500	-	625	B
11.500	12.500	0.550	0.825	11.502	12.498	X		X	X	X		XXXX	50011500	-	750	B
11.500	12.750	0.688	1.100	11.503	12.747					X		XXXX	62511500	-	1000	B

†For plastic compounds, see Table 3-1, page 3-11. For rubber compounds, see Table 3-3, page 3-14.

\*If used with wear rings, refer to wear ring throat diameter, see Section 9.

\*\*If used with wear rings, refer to wear ring piston diameter, see Section 9.

For custom groove calculations, see Appendix C.



**Standard, Deep and Type B PolyPak Profile**

**Table 6-8. Standard, Deep and Type B PolyPak Gland Dimensions — Inch (Continued)**

A Rod Diameter	B (Rod) Groove Diameter	C		D		Compound Codes (X = Standard Offering)†						Part Number				
		(Std. PP) Groove Width	(Deep & B) Groove Width	Throat Diameter*	Piston Diameter**	Standard PP		Deep PP		Type B		Compound Code	Energi-zer Code	Add to the part number for Type B or Deep only	Add to the part number for Type B only	
(Bore) Groove Diameter	Bore Diameter					Plastic	Rubber	Plastic	Rubber	Plastic	Rubber					
11.500	13.000	0.825	1.375	11.503	12.997					X		XXXX	75011500	-	1250	B
11.750	12.250	0.275	0.413	11.751	12.249	X						XXXX	25011750	-	375	B
11.750	12.500	0.413	0.688	11.752	12.498	X				X		XXXX	37511750	-	625	B
11.750	12.500	0.413	0.825	11.752	12.498					X		XXXX	37511750	-	750	B
11.750	12.750	0.550	0.825	11.752	12.748	X				X		XXXX	50011750	-	750	B
11.750	13.000	0.688	1.100	11.753	12.997					X		XXXX	62511750	-	1000	B
11.875	12.875	0.550	0.825	11.877	12.873					X		XXXX	50011875	-	750	B
12.000	12.500	0.275	0.413	12.001	12.499	X						XXXX	25012000	-	375	B
12.000	12.625	0.343	0.688	12.002	12.623	X						XXXX	31212000	-	625	B
12.000	12.750	0.413	0.688	12.002	12.748	X				X		XXXX	37512000	-	625	B
12.000	13.000	0.550	0.825	12.002	12.998	X				X		XXXX	50012000	-	750	B
12.000	13.250	0.688	1.100	12.003	13.247	X		X		X		XXXX	62512000	-	1000	B
12.000	13.500	0.825	1.375	12.003	13.497	X				X		XXXX	75012000	-	1250	B
12.000	14.000	1.100	1.650	12.004	13.996	X				X		XXXX	100012000	-	1500	B
12.125	13.125	0.550	0.825	12.127	13.123					X		XXXX	50012125	-	750	B
12.250	12.875	0.343	0.688	12.252	12.873					X		XXXX	31212250	-	625	B
12.250	13.000	0.413	0.688	12.252	12.998	X		X		X	X	XXXX	37512250	-	625	B
12.250	13.250	0.550	0.825	12.252	13.248					X		XXXX	50012250	-	750	B
12.250	13.500	0.688	1.100	12.253	13.497	X				X		XXXX	62512250	-	1000	B
12.250	13.875	0.893	1.238	12.253	13.872			X				XXXX	81212250	-	1125	B
12.500	13.000	0.275	0.413	12.501	12.999	X						XXXX	25012500	-	375	B
12.500	13.125	0.343	0.688	12.502	13.123					X		XXXX	31212500	-	625	B
12.500	13.500	0.550	0.825	12.502	13.498		X	X		X	X	XXXX	50012500	-	750	B
12.500	13.750	0.688	1.100	12.503	13.747			X				XXXX	62512500	-	1000	B
12.500	14.000	0.825	1.375	12.503	13.997	X	X			X		XXXX	75012500	-	1250	B
12.500	14.500	1.100	1.650	12.504	14.496	X						XXXX	100012500	-	1500	B
12.562	13.686	0.618	0.963	12.564	13.684					X		XXXX	56212562	-	875	B
12.562	13.812	0.688	0.963	12.565	13.809	X						XXXX	62501250	-	875	B
12.750	13.250	0.275	0.618	12.751	13.249	X				X		XXXX	25012750	-	562	B
12.750	13.375	0.343	0.688	12.752	13.373	X						XXXX	31212750	-	625	B
12.750	13.500	0.413	0.688	12.752	13.498	X				X	X	XXXX	37512750	-	625	B
12.750	13.750	0.550	0.825	12.752	13.748	X						XXXX	50012750	-	750	B
12.750	14.000	0.688	1.100	12.753	13.997	X		X	X			XXXX	62512750	-	1000	B
13.000	13.500	0.275	0.618	13.001	13.499		X	X		X		XXXX	25013000	-	562	B
13.000	13.750	0.413	0.413	13.002	13.748	X	X			X		XXXX	37513000	-	375	B
13.000	13.750	0.413	0.688	13.002	13.748					X		XXXX	37513000	-	625	B
13.000	14.000	0.550	0.825	13.002	13.998	X	X	X	X	X		XXXX	50013000	-	750	B
13.000	14.250	0.688	1.100	13.003	14.247	X						XXXX	62513000	-	1000	B
13.000	14.500	0.825	1.100	13.003	14.497	X				X		XXXX	75013000	-	1000	B
13.187	14.000	0.447	0.688	13.189	13.998	X						XXXX	40613187	-	625	B
13.250	14.000	0.413	0.618	13.252	13.998				X			XXXX	37513250	-	562	B
13.250	14.000	0.413	0.688	13.252	13.998	X				X	X	XXXX	37513250	-	625	B

†For plastic compounds, see Table 3-1, page 3-11. For rubber compounds, see Table 3-3, page 3-14.

\*If used with wear rings, refer to wear ring throat diameter, see Section 9.

\*\*If used with wear rings, refer to wear ring piston diameter, see Section 9.

For custom groove calculations, see Appendix C.



Table 6-8. Standard, Deep and Type B PolyPak Gland Dimensions — Inch (Continued)

A Rod Diameter	B (Rod) Groove Diameter	C		D		Compound Codes (X = Standard Offering)†						Part Number				
		(Std. PP) Groove Width	(Deep & B) Groove Width	Throat Diameter*	Piston Diameter**	Standard PP		Deep PP		Type B		Compound Code	Energizer Code	Add to the part number for Type B or Deep only	Add to the part number for Type B only	
(Bore) Groove Diameter	Bore Diameter					Plastic	Rubber	Plastic	Rubber	Plastic	Rubber					
13.250	14.250	0.550	0.825	13.252	14.248			X		X		XXXX	50013250	-	750	B
13.375	14.000	0.343	0.688	13.377	13.998	X						XXXX	31213375	-	625	B
13.500	14.000	0.275	0.618	13.501	13.999	X	X			X		XXXX	25013500	-	562	B
13.500	14.250	0.413	0.688	13.502	14.248	X		X		X		XXXX	37513500	-	625	B
13.500	14.500	0.550	0.825	13.502	14.498	X		X		X		XXXX	50013500	-	750	B
13.500	14.750	0.688	0.963	13.503	14.747					X	X	XXXX	62513500	-	875	B
13.500	15.000	0.825	1.375	13.503	14.997	X						XXXX	75013500	-	1250	B
13.750	14.500	0.413	0.688	13.752	14.498	X				X		XXXX	37513750	-	625	B
13.750	15.250	0.825	1.375	13.753	15.247	X						XXXX	75013750	-	1250	B
14.000	14.500	0.275	0.413	14.001	14.499	X		X				XXXX	25014000	-	375	B
14.000	14.750	0.413	0.688	14.002	14.748	X						XXXX	37514000	-	625	B
14.000	15.000	0.550	0.825	14.002	14.998			X		X		XXXX	50014000	-	750	B
14.000	15.250	0.688	1.100	14.003	15.247					X		XXXX	62514000	-	1000	B
14.000	15.250	0.688	1.100	14.003	15.247	X						XXXX	62514750	-	1000	B
14.000	15.500	0.825	1.375	14.003	15.497	X	X			X		XXXX	75014000	-	1250	B
14.000	15.750	0.963	1.650	14.004	15.746			X				XXXX	87514000	-	1500	B
14.000	16.000	1.100	1.650	14.004	15.996	X				X		XXXX	100014000	-	1500	B
14.125	14.625	0.275	0.413	14.126	14.624	X						XXXX	25014125	-	375	B
14.250	14.750	0.275	0.413	14.251	14.749	X						XXXX	25014250	-	375	B
14.250	15.000	0.413	0.688	14.252	14.998					X		XXXX	37514250	-	625	B
14.250	15.250	0.550	0.825	14.252	15.248	X						XXXX	50014250	-	750	B
14.250	15.750	0.825	1.375	14.253	15.747	X						XXXX	75014250	-	1250	B
14.420	15.420	0.550	0.550	14.422	15.418					X		XXXX	50014420	-	500	B
14.500	15.000	0.275	0.413	14.501	14.999	X						XXXX	25014500	-	375	B
14.500	15.000	0.275	0.413	14.501	14.999			X	X			XXXX	25014500	-	375	B
14.500	15.250	0.413	0.688	14.502	15.248	X						XXXX	37514500	-	625	B
14.500	15.500	0.550	0.825	14.502	15.498	X						XXXX	50014500	-	750	B
14.500	16.000	0.825	1.375	14.503	15.997	X		X		X		XXXX	75014500	-	1250	B
14.750	15.500	0.413	0.688	14.752	15.498	X		X		X		XXXX	37514750	-	625	B
14.750	15.750	0.550	0.825	14.752	15.748					X		XXXX	50014750	-	750	B
14.750	16.000	0.688	1.100	14.753	15.997	X						XXXX	62515000	-	1000	B
14.750	16.250	0.825	1.375	14.753	16.247	X						XXXX	75014750	-	1250	B
14.875	15.500	0.343	0.688	14.877	15.498	X						XXXX	31214875	-	625	B
15.000	15.500	0.275	0.618	15.001	15.499		X			X		XXXX	25015000	-	562	B
15.000	15.750	0.413	0.688	15.002	15.748	X						XXXX	37515000	-	625	B
15.000	16.000	0.550	0.825	15.002	15.998	X	X	X	X	X		XXXX	50015000	-	750	B
15.000	16.500	0.825	1.375	15.003	16.497			X				XXXX	75015000	-	1250	B
15.000	17.000	1.100	1.650	15.004	16.996					X		XXXX	100015000	-	1500	B
15.250	16.000	0.413	0.688	15.252	15.998			X	X			XXXX	37515250	-	625	B
15.250	16.250	0.550	0.825	15.252	16.248					X		XXXX	50015250	-	750	B
15.250	16.500	0.688	1.100	15.253	16.497					X		XXXX	62515250	-	1000	B
15.375	16.000	0.343	0.688	15.377	15.998			X				XXXX	31215375	-	625	B

†For plastic compounds, see Table 3-1, page 3-11. For rubber compounds, see Table 3-3, page 3-14.

\*If used with wear rings, refer to wear ring throat diameter, see Section 9.

\*\*If used with wear rings, refer to wear ring piston diameter, see Section 9.

For custom groove calculations, see Appendix C.



**Standard, Deep and Type B PolyPak Profile**

**Table 6-8. Standard, Deep and Type B PolyPak Gland Dimensions — Inch (Continued)**

A Rod Diameter	B (Rod) Groove Diameter	C		D		Compound Codes (X = Standard Offering)†						Part Number				
		(Std. PP) Groove Width	(Deep & B) Groove Width	Throat Diameter*	Piston Diameter**	Standard PP		Deep PP		Type B		Compound Code	Energi-zer Code	Add to the part number for Type B or Deep only	Add to the part number for Type B only	
(Bore) Groove Diameter	Bore Diameter					Plastic	Rubber	Plastic	Rubber	Plastic	Rubber					
15.500	16.000	0.275	0.413	15.501	15.999	X						XXXX	25015500	-	375	B
15.500	16.250	0.413	0.688	15.502	16.248	X						XXXX	37515500	-	625	B
15.500	16.500	0.550	0.825	15.502	16.498	X		X	X	X	X	XXXX	50015500	-	750	B
15.500	16.750	0.688	1.100	15.503	16.747					X	X	XXXX	62515500	-	1000	B
15.625	16.250	0.343	0.688	15.627	16.248					X		XXXX	31215625	-	625	B
15.625	17.125	0.825	1.375	15.628	17.122					X		XXXX	75015625	-	1250	B
15.750	16.250	0.275	0.618	15.751	16.249			X				XXXX	25015750	-	562	B
15.750	16.500	0.413	0.688	15.752	16.498	X					X	XXXX	37515750	-	625	B
15.750	16.750	0.550	0.825	15.752	16.748	X						XXXX	50015750	-	750	B
15.875	16.500	0.343	0.688	15.877	16.498	X						XXXX	31215875	-	625	B
16.000	16.500	0.275	0.275	16.001	16.499			X				XXXX	25016000	-	250	B
16.000	16.500	0.275	0.413	16.001	16.499			X				XXXX	25016000	-	375	B
16.000	16.750	0.413	0.688	16.002	16.748	X		X				XXXX	37516000	-	625	B
16.000	17.000	0.550	0.825	16.002	16.998	X	X	X	X			XXXX	50016000	-	750	B
16.000	17.500	0.825	1.375	16.003	17.497	X	X					XXXX	75016000	-	1250	B
16.000	17.750	0.963	1.375	16.004	17.746			X				XXXX	87516000	-	1250	B
16.000	17.750	0.963	1.513	16.004	17.746			X				XXXX	87516000	-	1375	B
16.000	18.000	1.100	1.375	16.004	17.996	X		X		X		XXXX	100016000	-	1250	B
16.250	17.000	0.413	0.688	16.252	16.998	X						XXXX	37516250	-	625	B
16.263	16.763	0.275	0.413	16.264	16.762					X		XXXX	25016263	-	375	B
16.500	17.250	0.413	0.688	16.502	17.248	X						XXXX	37516500	-	625	B
16.500	17.500	0.550	0.825	16.502	17.498			X		X		XXXX	50016500	-	750	B
16.500	18.000	0.825	0.825	16.503	17.997			X				XXXX	75016500	-	750	B
16.500	18.000	0.825	1.375	16.503	17.997			X				XXXX	75016500	-	1250	B
16.750	17.750	0.550	0.825	16.752	17.748					X		XXXX	50016750	-	750	B
16.750	18.000	0.688	1.100	16.753	17.997	X						XXXX	62516750	-	1000	B
17.000	18.000	0.550	0.825	17.002	17.998	X	X	X	X	X		XXXX	50017000	-	750	B
17.000	19.000	1.100	1.375	17.004	18.996			X				XXXX	100017000	-	1250	B
17.250	18.000	0.413	0.688	17.252	17.998	X						XXXX	37517250	-	625	B
17.500	18.500	0.550	0.825	17.502	18.498	X				X		XXXX	50017500	-	750	B
17.500	18.750	0.688	1.100	17.503	18.747			X				XXXX	62517500	-	1000	B
17.500	19.500	1.100	1.650	17.504	19.496					X		XXXX	100017500	-	1500	B
17.625	19.125	0.825	1.375	17.628	19.122					X		XXXX	75017625	-	1250	B
17.750	18.500	0.413	0.550	17.752	18.498			X				XXXX	37517750	-	500	B
17.750	19.000	0.688	1.100	17.753	18.997					X		XXXX	62517750	-	1000	B
17.875	18.500	0.343	0.550	17.877	18.498						X	XXXX	31217875	-	500	B
17.875	18.563	0.377	0.688	17.877	18.561	X						XXXX	34301062	-	625	B
18.000	19.000	0.550	0.825	18.002	18.998			X		X		XXXX	50018000	-	750	B
18.000	19.250	0.688	1.375	18.003	19.247			X				XXXX	62518000	-	1250	B
18.000	19.500	0.825	1.375	18.003	19.497	X		X				XXXX	75018000	-	1250	B
18.000	19.750	0.963	1.375	18.004	19.746			X				XXXX	87518000	-	1250	B
18.000	20.000	1.100	1.650	18.004	19.996	X						XXXX	100018000	-	1500	B

†For plastic compounds, see Table 3-1, page 3-11. For rubber compounds, see Table 3-3, page 3-14.

\*If used with wear rings, refer to wear ring throat diameter, see Section 9.

\*\*If used with wear rings, refer to wear ring piston diameter, see Section 9.

For custom groove calculations, see Appendix C.



Table 6-8. Standard, Deep and Type B PolyPak Gland Dimensions — Inch (Continued)

A Rod Diameter	B (Rod) Groove Diameter	C		D		Compound Codes (X = Standard Offering)†						Part Number				
		(Std. PP) Groove Width	(Deep & B) Groove Width	Throat Diameter*	Piston Diameter**	Standard PP		Deep PP		Type B		Compound Code	Energizer Code	Add to the part number for Type B or Deep only	Add to the part number for Type B only	
(Bore) Groove Diameter	Bore Diameter					Plastic	Rubber	Plastic	Rubber	Plastic	Rubber					
18.187	18.937	0.413	0.688	18.189	18.935	X						XXXX	37518187	-	625	B
18.250	18.750	0.275	0.413	18.251	18.749					X		XXXX	25018250	-	375	B
18.500	19.500	0.550	0.825	18.502	19.498			X				XXXX	50018500	-	750	B
18.500	20.500	1.100	1.650	18.504	20.496	X						XXXX	100018500	-	1500	B
18.750	20.000	0.688	1.100	18.753	19.997	X	X			X		XXXX	62518750	-	1000	B
19.000	19.500	0.275	0.413	19.001	19.499	X						XXXX	25019000	-	375	B
19.000	20.000	0.550	0.825	19.002	19.998	X	X	X		X		XXXX	50019000	-	750	B
19.000	20.500	0.825	1.375	19.003	20.497	X				X		XXXX	75019000	-	1250	B
19.250	20.000	0.413	0.688	19.252	19.998					X	X	XXXX	37519250	-	625	B
19.250	20.500	0.688	1.100	19.253	20.497							XXXX	62519250	-	1000	B
19.250	21.000	0.963	1.513	19.254	20.996			X				XXXX	87519250	-	1375	B
19.375	20.250	0.481	0.550	19.377	20.248					X		XXXX	43719375	-	500	B
19.500	20.000	0.275	0.275	19.501	19.999			X				XXXX	25019500	-	250	B
19.500	20.000	0.275	0.343	19.501	19.999			X				XXXX	25019500	-	312	B
19.500	20.250	0.413	0.688	19.502	20.248	X						XXXX	37519500	-	625	B
19.500	20.500	0.550	0.825	19.502	20.498	X		X				XXXX	50019500	-	750	B
19.625	20.625	0.550	0.825	19.627	20.623					X		XXXX	50019625	-	750	B
19.750	21.000	0.688	1.100	19.753	20.997					X		XXXX	62519750	-	1000	B
20.000	21.000	0.550	0.825	20.002	20.998	X		X		X		XXXX	50020000	-	750	B
20.000	21.250	0.688	1.100	20.003	21.247	X						XXXX	62520000	-	1000	B
20.000	21.500	0.825	1.100	20.003	21.497					X		XXXX	75020000	-	1000	B
20.000	21.500	0.825	1.375	20.003	21.497			X		X		XXXX	75020000	-	1250	B
20.000	21.750	0.963	1.513	20.004	21.746	X						XXXX	87520000	-	1375	B
20.000	22.000	1.100	0.963	20.004	21.996			X				XXXX	100020000	-	875	B
20.000	22.000	1.100	1.650	20.004	21.996			X				XXXX	100020000	-	1500	B
20.250	21.250	0.550	0.825	20.252	21.248					X		XXXX	50020250	-	750	B
20.500	21.500	0.550	0.825	20.502	21.498			X				XXXX	50020500	-	750	B
20.500	22.000	0.825	1.100	20.503	21.997	X				X		XXXX	75020500	-	1000	B
20.750	21.500	0.413	0.550	20.752	21.498					X		XXXX	37520750	-	500	B
21.000	21.500	0.275	0.343	21.001	21.499			X				XXXX	25021000	-	312	B
21.000	22.000	0.550	0.825	21.002	21.998	X		X		X		XXXX	50021000	-	750	B
21.000	22.500	0.825	1.375	21.003	22.497			X				XXXX	75021000	-	1250	B
21.500	22.500	0.550	0.825	21.502	22.498			X				XXXX	50021500	-	750	B
21.500	23.000	0.825	1.375	21.503	22.997			X				XXXX	75021500	-	1250	B
21.750	22.250	0.275	0.413	21.751	22.249					X		XXXX	25021750	-	375	B
21.875	22.875	0.550	0.825	21.877	22.873	X						XXXX	50021875	-	750	B
22.000	23.000	0.550	0.825	22.002	22.998					X		XXXX	50022000	-	750	B
22.000	23.500	0.825	1.375	22.003	23.497	X		X				XXXX	75022000	-	1250	B
22.000	24.000	1.100	1.513	22.004	23.996			X				XXXX	100022000	-	1375	B
22.062	22.562	0.275	0.413	22.063	22.561					X		XXXX	25022062	-	375	B
22.500	23.000	0.275	0.343	22.501	22.999	X		X				XXXX	25022500	-	312	B
22.500	24.000	0.825	1.375	22.503	23.997			X				XXXX	75022500	-	1250	B

†For plastic compounds, see Table 3-1, page 3-11. For rubber compounds, see Table 3-3, page 3-14.

\*If used with wear rings, refer to wear ring throat diameter, see Section 9.

\*\*If used with wear rings, refer to wear ring piston diameter, see Section 9.

For custom groove calculations, see Appendix C.





**Standard, Deep and Type B PolyPak Profile**

**Table 6-8. Standard, Deep and Type B PolyPak Gland Dimensions — Inch (Continued)**

A	B	C		D		Compound Codes (X = Standard Offering)†						Part Number				
		(Std. PP) Groove Width	(Deep & B) Groove Width	Throat Diameter*	Piston Diameter**	Standard PP		Deep PP		Type B		Compound Code	Energi-zer Code	Add to the part number for Type B or Deep only	Add to the part number for Type B only	
(Rod) Diameter	(Rod) Groove Diameter	(Bore) Groove Diameter	(Bore) Diameter			Plastic	Rubber	Plastic	Rubber	Plastic	Rubber					
23.000	23.500					0.275	0.413	23.001	23.499	X				X		
23.000	23.750	0.413	0.688	23.002	23.748	X						XXXX	37523000	-	625	B
23.000	24.000	0.550	0.825	23.002	23.998	X						XXXX	50023000	-	750	B
23.250	24.000	0.413	0.688	23.252	23.998			X				XXXX	37523250	-	625	B
23.375	25.375	1.100	1.650	23.379	25.371	X						XXXX	100023375	-	1500	B
23.500	24.000	0.275	0.413	23.501	23.999	X						XXXX	25023500	-	375	B
23.500	24.500	0.550	0.825	23.502	24.498	X						XXXX	50023500	-	750	B
23.500	25.000	0.825	1.375	23.503	24.997					X		XXXX	75023500	-	1250	B
23.750	24.250	0.275	0.413	23.751	24.249					X		XXXX	25023750	-	375	B
24.000	24.500	0.275	0.413	24.001	24.499	X				X		XXXX	25024000	-	375	B
24.000	25.000	0.550	0.825	24.002	24.998					X		XXXX	50024000	-	750	B
24.000	25.500	0.825	1.375	24.003	25.497			X				XXXX	75024000	-	1250	B
24.000	25.750	0.963	1.375	24.004	25.746			X				XXXX	87524000	-	1250	B
24.000	26.000	1.100	1.650	24.004	25.996					X		XXXX	100024000	-	1500	B
24.500	25.000	0.275	0.413	24.501	24.999	X						XXXX	25024500	-	375	B
24.500	25.500	0.550	0.825	24.502	25.498					X		XXXX	50024500	-	750	B
24.750	26.000	0.688	1.100	24.753	25.997	X						XXXX	62524750	-	1000	B
24.875	25.875	0.550	0.825	24.877	25.873					X		XXXX	50024875	-	750	B
25.000	25.750	0.413	0.688	25.002	25.748	X				X		XXXX	37525000	-	625	B
25.000	26.000	0.550	0.825	25.002	25.998	X						XXXX	50025000	-	750	B
25.000	27.000	1.100	1.477	25.004	26.996			X				XXXX	100025000	-	1343	B
25.250	25.750	0.275	0.413	25.251	25.749					X		XXXX	25025250	-	375	B
25.250	26.000	0.413	0.688	25.252	25.998	X						XXXX	37525250	-	625	B
25.250	26.250	0.550	0.825	25.252	26.248			X				XXXX	50025250	-	750	B
25.500	27.000	0.825	1.375	25.503	26.997	X						XXXX	75025500	-	1250	B
26.000	26.750	0.413	0.688	26.002	26.748						X	XXXX	37526000	-	625	B
26.000	27.000	0.550	0.825	26.002	26.998	X						XXXX	50026000	-	750	B
26.000	27.500	0.825	1.375	26.003	27.497	X						XXXX	75026000	-	1250	B
26.125	27.125	0.550	0.825	26.127	27.123					X		XXXX	50026125	-	750	B
26.500	27.500	0.550	0.825	26.502	27.498	X						XXXX	50026500	-	750	B
26.718	27.218	0.275	0.343	26.719	27.217			X				XXXX	25026718	-	312	B
27.000	28.000	0.550	0.825	27.002	27.998			X		X		XXXX	50027000	-	750	B
27.000	29.000	1.100	1.650	27.004	28.996	X						XXXX	100027000	-	1500	B
27.250	28.000	0.413	0.688	27.252	27.998	X						XXXX	37527250	-	625	B
27.500	28.000	0.275	0.413	27.501	27.999	X						XXXX	25027500	-	375	B
27.500	28.500	0.550	0.825	27.502	28.498			X				XXXX	50027500	-	750	B
27.625	28.625	0.550	0.825	27.627	28.623					X		XXXX	50027625	-	750	B
28.000	29.000	0.550	0.825	28.002	28.998	X						XXXX	50028000	-	750	B
28.000	30.000	1.100	1.650	28.004	29.996	X						XXXX	100028000	-	1500	B
28.187	29.187	0.550	0.825	28.189	29.185					X		XXXX	50028187	-	750	B
28.500	29.500	0.550	0.825	28.502	29.498	X						XXXX	50028500	-	750	B
28.500	29.500	0.550	0.825	28.502	29.498			X				XXXX	50028500	-	750	B

†For plastic compounds, see Table 3-1, page 3-11. For rubber compounds, see Table 3-3, page 3-14.

\*If used with wear rings, refer to wear ring throat diameter, see Section 9.

\*\*If used with wear rings, refer to wear ring piston diameter, see Section 9.

For custom groove calculations, see Appendix C.





Table 6-8. Standard, Deep and Type B PolyPak Gland Dimensions — Inch (Continued)

A Rod Diameter	B (Rod) Groove Diameter	C		D		Compound Codes (X = Standard Offering)†						Part Number				
		(Std. PP) Groove Width	(Deep & B) Groove Width	Throat Diameter*	Piston Diameter**	Standard PP		Deep PP		Type B		Compound Code	Energizer Code	Add to the part number for Type B or Deep only	Add to the part number for Type B only	
(Bore) Groove Diameter	Bore Diameter					Plastic	Rubber	Plastic	Rubber	Plastic	Rubber					
28.750	29.500	0.413	0.688	28.752	29.498			X				XXXX	37528750	-	625	B
29.000	30.000	0.550	0.825	29.002	29.998			X		X		XXXX	50029000	-	750	B
29.000	31.000	1.100	1.650	29.004	30.996					X		XXXX	100029000	-	1500	B
29.750	30.750	0.550	0.825	29.752	30.748					X		XXXX	50029750	-	750	B
30.000	30.750	0.413	0.688	30.002	30.748					X		XXXX	37530000	-	625	B
30.000	30.750	0.413	0.688	30.002	30.748	X						XXXX	37531750	-	625	B
30.000	31.000	0.550	0.687	30.002	30.998			X				XXXX	50030000	-	625	B
30.000	31.250	0.688	1.100	30.003	31.247					X		XXXX	62530000	-	1000	B
30.000	32.000	1.100	1.650	30.004	31.996					X		XXXX	100030000	-	1500	B
30.250	31.250	0.550	0.825	30.252	31.248			X				XXXX	50030250	-	750	B
30.375	31.375	0.550	0.825	30.377	31.373					X		XXXX	50030375	-	750	B
30.750	31.750	0.550	0.825	30.752	31.748					X		XXXX	50030750	-	750	B
31.000	32.000	0.550	0.825	31.002	31.998	X						XXXX	50031000	-	750	B
31.000	33.000	1.100	1.650	31.004	32.996	X						XXXX	100031000	-	1500	B
31.500	32.250	0.413	0.688	31.502	32.248			X				XXXX	37531500	-	625	B
31.500	32.500	0.550	0.825	31.502	32.498					X		XXXX	50031500	-	750	B
31.750	32.500	0.413	0.688	31.752	32.498	X						XXXX	37536250	-	625	B
32.000	32.500	0.275	0.413	32.001	32.499	X						XXXX	25032000	-	375	B
32.000	33.000	0.550	0.825	32.002	32.998	X						XXXX	50032000	-	750	B
32.000	33.500	0.825	0.963	32.003	33.497			X				XXXX	75032000	-	875	B
33.000	34.000	0.550	0.825	33.002	33.998			X		X		XXXX	50033000	-	750	B
34.000	34.750	0.413	0.688	34.002	34.748			X				XXXX	37534000	-	625	B
34.500	35.000	0.275	0.413	34.501	34.999	X						XXXX	25034500	-	375	B
34.500	35.500	0.550	0.825	34.502	35.498					X		XXXX	50034500	-	750	B
35.000	35.750	0.413	0.688	35.002	35.748			X				XXXX	37535000	-	625	B
35.750	36.750	0.550	0.825	35.752	36.748	X						XXXX	50035750	-	750	B
36.000	36.750	0.413	0.688	36.002	36.748			X				XXXX	37536000	-	625	B
36.000	37.000	0.550	0.825	36.002	36.998	X						XXXX	50036000	-	750	B
37.000	37.750	0.413	0.688	37.002	37.748			X				XXXX	37537000	-	625	B
37.000	38.000	0.550	0.825	37.002	37.998	X		X				XXXX	50037000	-	750	B
37.500	38.250	0.413	0.688	37.502	38.248	X						XXXX	37537500	-	625	B
38.000	39.000	0.550	0.825	38.002	38.998					X		XXXX	50038000	-	750	B
38.250	39.250	0.550	0.825	38.252	39.248					X		XXXX	50038250	-	750	B
38.500	39.250	0.413	0.688	38.502	39.248	X						XXXX	37538500	-	625	B
38.750	39.750	0.550	0.825	38.752	39.748					X		XXXX	50038750	-	750	B
39.135	40.135	0.550	0.825	39.137	40.133	X						XXXX	50039135	-	750	B
40.000	40.750	0.413	0.688	40.002	40.748			X				XXXX	37540000	-	625	B
41.000	42.000	0.550	0.825	41.002	41.998					X		XXXX	50041000	-	750	B
41.485	42.485	0.550	0.825	41.487	42.483	X						XXXX	50041485	-	750	B
41.750	42.750	0.550	0.825	41.752	42.748					X		XXXX	50041750	-	750	B
42.000	43.000	0.550	0.688	42.002	42.998					X		XXXX	50042000	-	625	B
42.000	43.000	0.550	0.825	42.002	42.998					X		XXXX	50042000	-	750	B

†For plastic compounds, see Table 3-1, page 3-11. For rubber compounds, see Table 3-3, page 3-14.

\*If used with wear rings, refer to wear ring throat diameter, see Section 9.

\*\*If used with wear rings, refer to wear ring piston diameter, see Section 9.

For custom groove calculations, see Appendix C.



**Standard, Deep and Type B PolyPak Profile**

**Table 6-8. Standard, Deep and Type B PolyPak Gland Dimensions — Inch (Continued)**

A Rod Diameter	B (Rod) Groove Diameter	C		D		Compound Codes (X = Standard Offering)†						Part Number				
		(Std. PP) Groove Width	(Deep & B) Groove Width	Throat Diameter*	Piston Diameter**	Standard PP		Deep PP		Type B		Compound Code	Energizer Code	Add to the part number for Type B or Deep only	Add to the part number for Type B only	
(Bore) Groove Diameter	Bore Diameter					Plastic	Rubber	Plastic	Rubber	Plastic	Rubber					
42.267	43.267	0.550	0.825	42.269	43.265	X						XXXX	50042267	-	750	B
43.500	44.500	0.550	0.825	43.502	44.498					X		XXXX	50043500	-	750	B
44.125	45.125	0.550	0.825	44.127	45.123					X		XXXX	50044125	-	750	B
44.618	45.618	0.550	0.825	44.620	45.616	X						XXXX	50044618	-	750	B
46.250	47.250	0.550	0.825	46.252	47.248					X		XXXX	50046250	-	750	B
47.500	48.500	0.550	0.825	47.502	48.498					X		XXXX	50047500	-	750	B

†For plastic compounds, see Table 3-1, page 3-11. For rubber compounds, see Table 3-3, page 3-14.

\*If used with wear rings, refer to wear ring throat diameter, see Section 9.

\*\*If used with wear rings, refer to wear ring piston diameter, see Section 9.

For custom groove calculations, see Appendix C.

NOTE: For sizes larger than those shown in the table, please contact your local Parker Seal representative.

# Symmetrical Seal SL Profile

Catalog EPS 5370/USA



## SL Profile, Dual Compound Dual Lip Seal

Parker's SL profile is considered a multiple lip seal. The primary sealing lip is provided by the precision knife trimmed rubber element that snaps into the Molythane base. The base of the SL profile provides the secondary lip which is aligned directly below the primary lip to provide extrusion, and wear resistance. The SL Profile combines the sealing benefit of rubber with the wear and strength of Molythane. The beveled rubber lip geometry is excellent for cutting fluid film and the squeeze forces across the lips maintain sealing contact under low pressure or vacuum. The ability of Parker to supply a variety of rubber compounds allows the SL profile to be compatible with a wide range of pressure, temperature and fluids. The SL profile is designed to work as a stand alone rod seal or can be used in tandem with a buffer seal. In piston applications, this seal will function as a unidirectional seal. SL profiles should not be installed back to back in bi-directional pressure applications, as a pressure trap between the seals may occur.



SL Cross-Section

## Technical Data

Standard Materials*	Temperature Range	Pressure Range†	Surface Speed
<b>Rubber Element:</b>			
N4180A80	-40°F to 250°F (-40°C to 121°C)	1,250 psi (86 bar)	< 1.6 ft/s (0.5 m/s)
<b>Base:</b>			
P4615A90	-65°F to 200°F (-54°C to 93°C)	5,000 psi (344 bar)	< 1.6 ft/s (0.5 m/s)

\***Alternate Materials:** For applications that may require an alternate material, please contact your local Parker Seal representative.

†**Pressure Range** without wear rings (see Table 2-4, page 2-5).

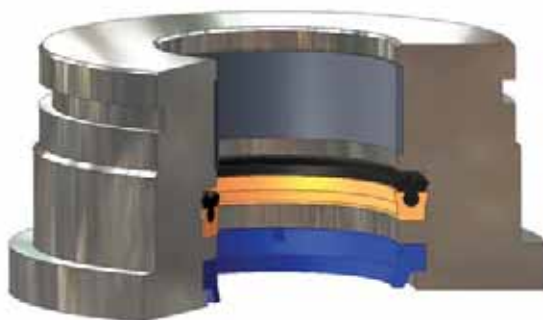

SL installed in Rod Gland

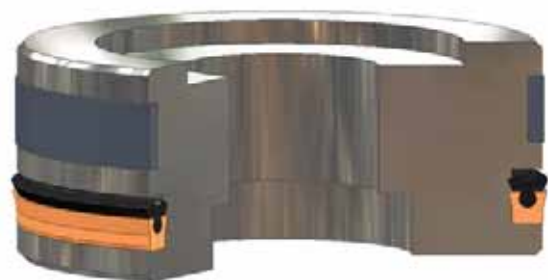

SL installed in Piston Gland

09/01/07

**SL Profile**

**Part Number Nomenclature — SL Profile**

Table 6-9. SL Profile — Inch

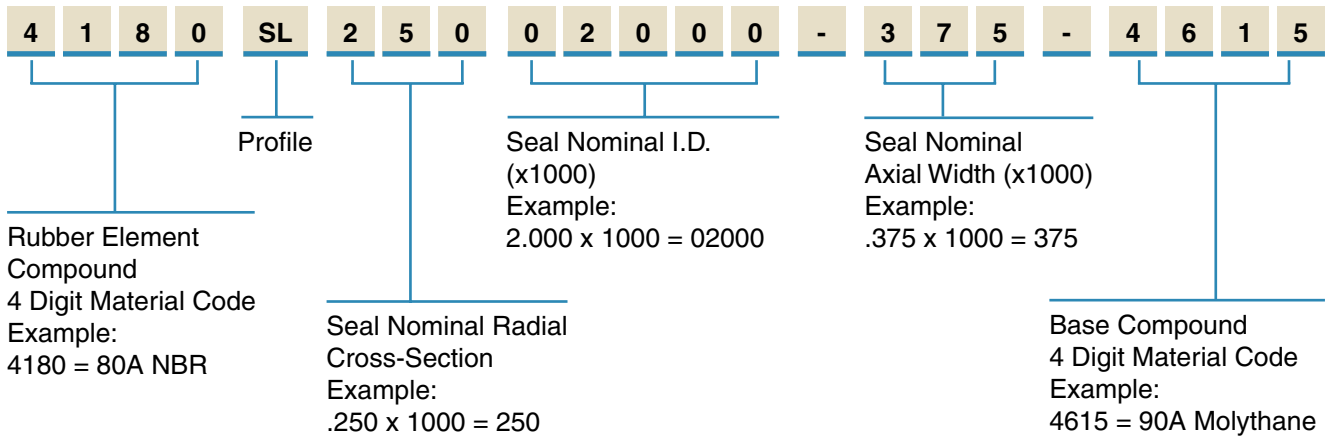

**Gland Dimensions — SL Profile**

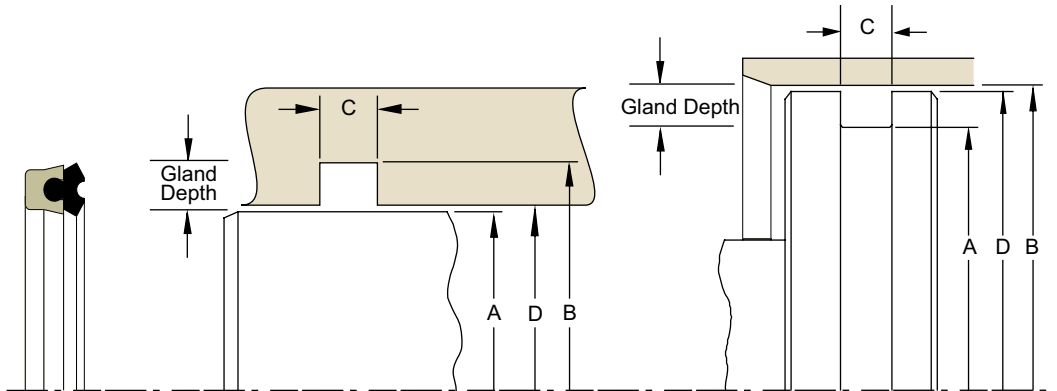

Table 6-10A. Rod Gland Dimension Tolerances

Nominal Gland Depth	A Rod Diameter	B Groove Diameter	C Groove Width	D Throat Diameter
1/8	+0.000/-0.001	+0.002/-0.000	+0.015/-0.000	+0.002/-0.000
3/16	+0.000/-0.002	+0.002/-0.000		+0.002/-0.000
1/4	+0.000/-0.002	+0.003/-0.000		+0.003/-0.000
5/16	+0.000/-0.002	+0.004/-0.000		+0.003/-0.000
3/8	+0.000/-0.002	+0.005/-0.000		+0.004/-0.000
7/16	+0.000/-0.003	+0.006/-0.000		+0.004/-0.000
1/2	+0.000/-0.003	+0.007/-0.000		+0.005/-0.000
5/8	+0.000/-0.003	+0.009/-0.000		+0.006/-0.000
3/4	+0.000/-0.004	+0.011/-0.000		+0.007/-0.000
1	+0.000/-0.005	+0.015/-0.000		+0.009/-0.000

Table 6-10B. Piston Gland Dimension Tolerances

Nominal Gland Depth	B Bore Diameter	A Groove Diameter	C Groove Width	D Piston Diameter
1/8	+0.002/-0.000	+0.000/-0.002	+0.015/-0.000	+0.000/-0.001
3/16	+0.002/-0.000	+0.000/-0.002		+0.000/-0.002
1/4	+0.003/-0.000	+0.000/-0.003		+0.000/-0.002
5/16	+0.003/-0.000	+0.000/-0.004		+0.000/-0.002
3/8	+0.004/-0.000	+0.000/-0.005		+0.000/-0.002
7/16	+0.005/-0.000	+0.000/-0.006		+0.000/-0.002
1/2	+0.005/-0.000	+0.000/-0.007		+0.000/-0.003
9/16	+0.006/-0.000	+0.000/-0.008		+0.000/-0.003
5/8	+0.006/-0.000	+0.000/-0.009		+0.000/-0.003
3/4	+0.007/-0.000	+0.000/-0.010		+0.000/-0.004
7/8	+0.008/-0.000	+0.000/-0.011	+0.000/-0.005	
1	+0.009/-0.000	+0.000/-0.012	+0.000/-0.005	

Please refer to Engineering Section 2, page 2-8 for surface finish and additional hardware considerations.

Table 6-11. SL Gland Dimensions — Inch

A	B	C	D		Part Number
Rod Diameter	(Rod) Groove Diameter	(Rod) Groove Width	Throat Diameter*		
(Bore) Groove Diameter	Bore Diameter	(Bore) Groove Width		(Bore) Piston Diameter**	
1.125	1.500	0.343	1.126	1.499	4180SL18701125-312-4615
1.250	1.625	0.343	1.251	1.624	4180SL18701250-312-4615
1.250	1.875	0.550	1.252	1.873	4180SL31201250-500-4615
1.500	1.875	0.412	1.501	1.874	4180SL18701500-375-4615
1.500	2.000	0.412	1.501	1.999	4180SL25001500-375-4615
1.625	2.000	0.412	1.626	1.999	4180SL18701625-375-4615
1.750	2.125	0.412	1.751	2.124	4180SL18701750-375-4615
1.750	2.250	0.412	1.751	2.249	4180SL25001750-375-4615
1.750	2.500	0.687	1.752	2.498	4180SL37501750-625-4615
2.000	2.375	0.412	2.001	2.374	4180SL18702000-375-4615
2.000	2.500	0.412	2.001	2.499	4180SL25002000-375-4615
2.000	2.750	0.687	2.002	2.748	4180SL37502000-625-4615
2.500	3.000	0.412	2.501	2.999	4180SL25002500-375-4615
2.625	3.375	0.687	2.627	3.373	4180SL37502625-625-4615
2.750	3.250	0.412	2.751	3.249	4180SL25002750-375-4615
3.000	3.500	0.412	3.001	3.499	4180SL25003000-375-4615
3.250	3.750	0.412	3.251	3.749	4180SL25003250-375-4615
3.500	4.000	0.412	3.501	3.999	4180SL25003500-375-4615
3.500	4.250	0.687	3.502	4.248	4180SL37503500-625-4615
4.000	4.500	0.412	4.001	4.499	4180SL25004000-375-4615
4.250	4.750	0.412	4.251	4.749	4180SL25004250-375-4615
4.500	5.000	0.412	4.501	4.999	4180SL25004500-375-4615
4.750	5.250	0.412	4.751	5.249	4180SL25004750-375-4615
5.250	5.750	0.412	5.251	5.749	4180SL25005250-375-4615
6.500	7.500	0.825	6.502	7.498	4180SL50006500-750-4615

\*If used with wear rings, refer to wear ring throat diameter, see Section 9.

\*\*If used with wear rings, refer to wear ring piston diameter, see Section 9.

For custom groove calculations, see Appendix C.

NOTE: For sizes larger than those shown in the table, please contact your local Parker Seal representative.

# Symmetrical Seal US Profile

Catalog EPS 5370/USA

## US Profile, Symmetrical u-cup Seal



The Parker US profile is a symmetrical, beveled lip u-cup designed for use in hydraulic cylinder applications. The symmetrical shape allows interchangeability between rod and piston applications. A precision knife trimming process is utilized to create the beveled sealing lips. This ensures that the inside and outside diameter sealing edges provide excellent fluid wiping action. The US profile is a single acting seal. Two seals can be installed back to back, in separate grooves, to seal dual acting pistons without pressure trapping fluid between the seals. The US profile is an economical choice, available in Parker's wear and extrusion resistant Molythane compound.

## Technical Data

Standard Materials*	Temperature Range	Pressure Range†	Surface Speed
P4615A90	-65°F to 200°F (-54°C to 93°C)	5,000 psi (344 bar)	< 1.6 ft/s (0.5 m/s)

\***Alternate Materials:** For applications that may require an alternate material, please contact your local Parker Seal representative.

†**Pressure Range** without wear rings (see Table 2-4, page 2-5).



*US Cross-Section*

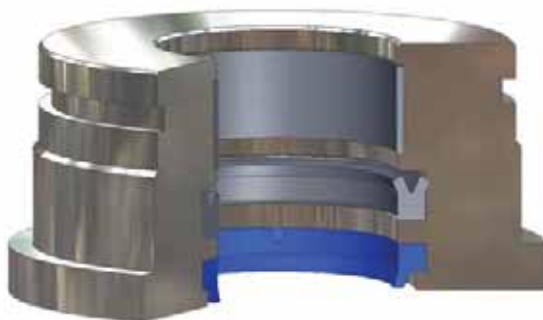

*US installed in Rod Gland*

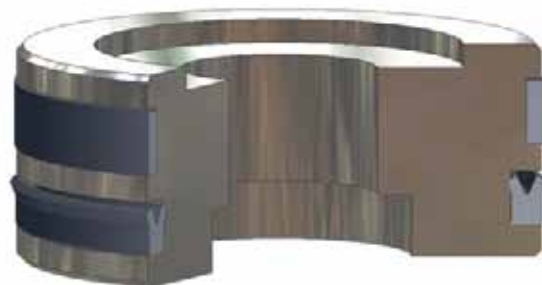

*US installed in Piston Gland*

09/01/07



**Part Number Nomenclature — US Profile**

**Table 6-12. US Profile — Inch**

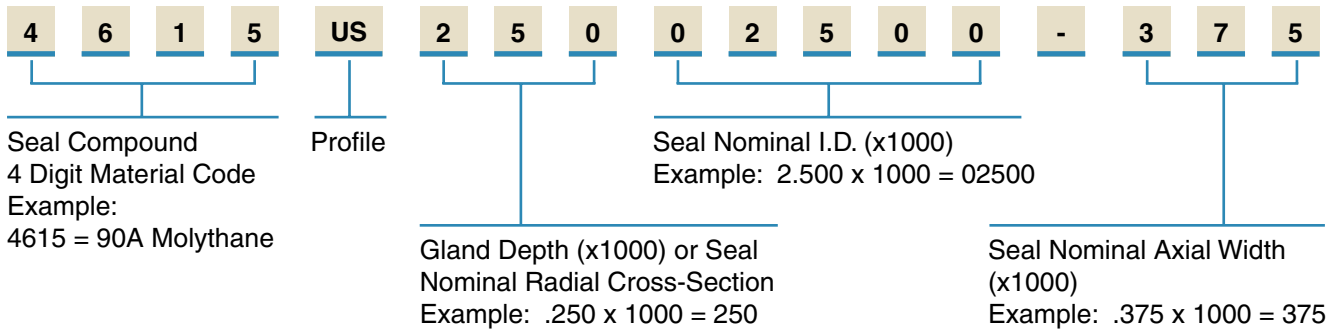

**Gland Dimensions — US Profile**

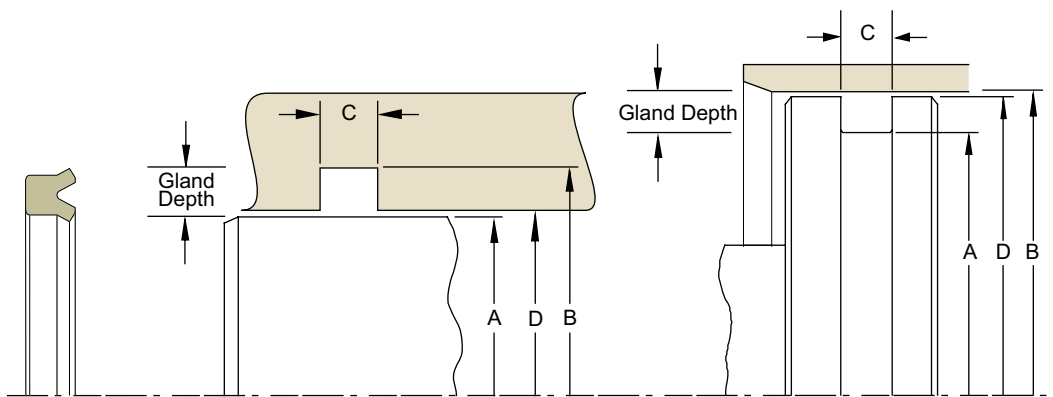

**Table 6-13A. Rod Gland Dimension Tolerances**

Nominal Gland Depth	A Rod Diameter	B Groove Diameter	C Groove Width	D Throat Diameter
1/8	+0.000/-0.001	+0.002/-0.000	+0.015/-0.000	+0.002/-0.000
3/16	+0.000/-0.002	+0.002/-0.000		+0.002/-0.000
1/4	+0.000/-0.002	+0.003/-0.000		+0.003/-0.000
5/16	+0.000/-0.002	+0.004/-0.000		+0.003/-0.000
3/8	+0.000/-0.002	+0.005/-0.000		+0.004/-0.000
7/16	+0.000/-0.003	+0.006/-0.000		+0.004/-0.000
1/2	+0.000/-0.003	+0.007/-0.000		+0.005/-0.000
5/8	+0.000/-0.003	+0.009/-0.000		+0.006/-0.000
3/4	+0.000/-0.004	+0.011/-0.000		+0.007/-0.000
1	+0.000/-0.005	+0.015/-0.000		+0.009/-0.000

**Table 6-13B. Piston Gland Dimension Tolerances**

Nominal Gland Depth	B Bore Diameter	A Groove Diameter	C Groove Width	D Piston Diameter
1/8	+0.002/-0.000	+0.000/-0.002	+0.015/-0.000	+0.000/-0.001
3/16	+0.002/-0.000	+0.000/-0.002		+0.000/-0.002
1/4	+0.003/-0.000	+0.000/-0.003		+0.000/-0.002
5/16	+0.003/-0.000	+0.000/-0.004		+0.000/-0.002
3/8	+0.004/-0.000	+0.000/-0.005		+0.000/-0.002
7/16	+0.005/-0.000	+0.000/-0.006		+0.000/-0.002
1/2	+0.005/-0.000	+0.000/-0.007		+0.000/-0.003
9/16	+0.006/-0.000	+0.000/-0.008		+0.000/-0.003
5/8	+0.006/-0.000	+0.000/-0.009		+0.000/-0.003
3/4	+0.007/-0.000	+0.000/-0.010		+0.000/-0.004
7/8	+0.008/-0.000	+0.000/-0.011	+0.000/-0.005	
1	+0.009/-0.000	+0.000/-0.012	+0.000/-0.005	

Please refer to Engineering Section 2, page 2-8 for surface finish and additional hardware considerations.



**Table 6-14. US Gland Dimensions — Inch**

A Rod Diameter	B (Rod) Groove Diameter	C (Rod) Groove Width	D		Part Number
			Throat Diameter*	(Bore) Piston Diameter**	
			(Bore) Groove Diameter		
0.093	0.343	0.138	0.094	0.342	4615US12500093-125
0.187	0.562	0.343	0.188	0.561	4615US18700187-312
0.250	0.500	0.275	0.251	0.499	4615US12500250-250
0.250	0.625	0.343	0.251	0.624	4615US18700250-312
0.250	0.750	0.343	0.251	0.749	4615US25000250-312
0.312	0.562	0.138	0.313	0.561	4615US12500312-125
0.312	0.562	0.275	0.313	0.561	4615US12500312-250
0.312	0.812	0.343	0.313	0.811	4615US25000312-312
0.312	0.812	0.413	0.313	0.811	4615US25000312-375
0.375	0.625	0.275	0.376	0.624	4615US12500375-250
0.375	0.750	0.206	0.376	0.749	4615US18700375-187
0.375	0.750	0.343	0.376	0.749	4615US18700375-312
0.375	0.875	0.343	0.376	0.874	4615US25000375-312
0.437	0.687	0.206	0.438	0.686	4615US12500437-187
0.500	0.750	0.138	0.501	0.749	4615US12500500-125
0.500	0.750	0.275	0.501	0.749	4615US12500500-250
0.500	0.875	0.275	0.501	0.874	4615US18700500-250
0.500	0.875	0.343	0.501	0.874	4615US18700500-312
0.562	0.750	0.102	0.563	0.749	4615US09300562-093
0.500	1.000	0.275	0.501	0.999	4615US25000500-250
0.562	1.062	0.275	0.563	1.061	4615US25000562-250
0.625	0.875	0.138	0.626	0.874	4615US12500625-125
0.625	0.875	0.206	0.626	0.874	4615US12500625-187
0.625	0.875	0.275	0.626	0.874	4615US12500625-250
0.625	1.000	0.275	0.626	0.999	4615US18700625-250
0.625	1.000	0.343	0.626	0.999	4615US18700625-312
0.625	1.125	0.413	0.626	1.124	4615US25000625-375
0.750	1.000	0.138	0.751	0.999	4615US12500750-125
0.750	1.000	0.206	0.751	0.999	4615US12500750-187
0.750	1.125	0.343	0.751	1.124	4615US18700750-312
0.750	1.250	0.275	0.751	1.249	4615US25000750-250
0.750	1.250	0.413	0.751	1.249	4615US25000750-375
0.812	1.062	0.275	0.813	1.061	4615US12500812-250
0.812	1.187	0.343	0.813	1.186	4615US18700812-312
0.875	1.125	0.189	0.876	1.124	4615US12500875-172
0.875	1.125	0.275	0.876	1.124	4615US12500875-250
0.875	1.250	0.275	0.876	1.249	4615US18700875-250
0.875	1.250	0.343	0.876	1.249	4615US18700875-312

\*If used with wear rings, refer to wear ring throat diameter, see Section 9.

\*\*If used with wear rings, refer to wear ring piston diameter, see Section 9.

For custom groove calculations, see Appendix C.

Table 6-14. US Gland Dimensions — Inch (Continued)

A	B	C	D		Part Number
Rod Diameter	(Rod) Groove Diameter	(Rod) Groove Width	Throat Diameter*	(Bore) Piston Diameter**	
(Bore) Groove Diameter	Bore Diameter	(Bore) Groove Width			
1.000	1.250	0.138	1.001	1.249	4615US12501000-125
1.000	1.250	0.275	1.001	1.249	4615US12501000-250
1.000	1.375	0.206	1.001	1.374	4615US18701000-187
1.000	1.375	0.343	1.001	1.374	4615US18701000-312
1.000	1.500	0.275	1.001	1.499	4615US25001000-250
1.000	1.500	0.413	1.001	1.499	4615US25001000-375
1.125	1.375	0.206	1.126	1.374	4615US12501125-187
1.125	1.500	0.206	1.126	1.499	4615US18701125-187
1.125	1.500	0.275	1.126	1.499	4615US18701125-250
1.125	1.625	0.275	1.126	1.624	4615US25001125-250
1.187	1.687	0.275	1.188	1.686	4615US25001187-250
1.250	1.500	0.138	1.251	1.499	4615US12501250-125
1.250	1.500	0.206	1.251	1.499	4615US12501250-187
1.250	1.500	0.275	1.251	1.499	4615US12501250-250
1.250	1.625	0.413	1.251	1.624	4615US18701250-375
1.250	1.750	0.275	1.251	1.749	4615US25001250-250
1.250	1.750	0.413	1.251	1.749	4615US25001250-375
1.250	1.875	0.413	1.252	1.873	4615US31201250-375
1.312	1.687	0.343	1.313	1.686	4615US18701312-312
1.375	1.625	0.172	1.376	1.624	4615US12501375-156
1.375	1.625	0.206	1.376	1.624	4615US12501375-187
1.375	1.750	0.343	1.376	1.749	4615US18701375-312
1.375	1.875	0.413	1.376	1.874	4615US25001375-375
1.375	2.000	0.343	1.377	1.998	4615US31201375-312
1.500	1.750	0.206	1.501	1.749	4615US12501500-187
1.500	1.750	0.275	1.501	1.749	4615US12501500-250
1.500	1.875	0.206	1.501	1.874	4615US18701500-187
1.500	1.875	0.343	1.501	1.874	4615US18701500-312
1.500	1.875	0.413	1.501	1.874	4615US18701500-375
1.500	2.000	0.343	1.501	1.999	4615US25001500-312
1.500	2.000	0.413	1.501	1.999	4615US25001500-375
1.500	2.125	0.343	1.502	2.123	4615US31201500-312
1.625	2.000	0.206	1.626	1.999	4615US18701625-187
1.625	2.000	0.275	1.626	1.999	4615US18701625-250
1.625	2.000	0.343	1.626	1.999	4615US18701625-312
1.625	2.000	0.413	1.626	1.999	4615US18701625-375
1.750	2.000	0.138	1.751	1.999	4615US12501750-125
1.750	2.125	0.206	1.751	2.124	4615US18701750-187

\*If used with wear rings, refer to wear ring throat diameter, see Section 9.

\*\*If used with wear rings, refer to wear ring piston diameter, see Section 9.

For custom groove calculations, see Appendix C.

**Table 6-14. US Gland Dimensions — Inch (Continued)**

A	B	C	D		Part Number
Rod Diameter	(Rod) Groove Diameter	(Rod) Groove Width	Throat Diameter*		
(Bore) Groove Diameter	Bore Diameter	(Bore) Groove Width		(Bore) Piston Diameter**	
1.750	2.125	0.275	1.751	2.124	4615US18701750-250
1.750	2.125	0.343	1.751	2.124	4615US18701750-312
1.750	2.125	0.413	1.751	2.124	4615US18701750-375
1.750	2.375	0.343	1.752	2.373	4615US31201750-312
1.875	2.250	0.308	1.876	2.249	4615US18701875-280
1.875	2.500	0.343	1.877	2.498	4615US31201875-312
1.875	2.500	0.550	1.877	2.498	4615US31201875-500
2.000	2.375	0.275	2.001	2.374	4615US18702000-250
2.000	2.375	0.343	2.001	2.374	4615US18702000-312
2.000	2.375	0.413	2.001	2.374	4615US18702000-375
2.000	2.500	0.413	2.001	2.499	4615US25002000-375
2.000	2.625	0.413	2.002	2.623	4615US31202000-375
2.125	2.500	0.206	2.126	2.499	4615US18702125-187
2.125	2.500	0.343	2.126	2.499	4615US18702125-312
2.250	2.625	0.343	2.251	2.624	4615US18702250-312
2.250	2.750	0.413	2.251	2.749	4615US25002250-375
2.250	2.875	0.550	2.252	2.873	4615US31202250-500
2.250	3.000	0.688	2.252	2.998	4615US37502250-625
2.375	2.875	0.413	2.376	2.874	4615US25002375-375
2.500	2.875	0.343	2.501	2.874	4615US18702500-312
2.500	2.875	0.413	2.501	2.874	4615US18702500-375
2.500	3.000	0.343	2.501	2.999	4615US25002500-312
2.500	3.000	0.413	2.501	2.999	4615US25002500-375
2.500	3.125	0.413	2.502	3.123	4615US31202500-375
2.625	3.000	0.413	2.626	2.999	4615US18702625-375
2.625	3.250	0.550	2.627	3.248	4615US31202625-500
2.750	3.250	0.275	2.751	3.249	4615US25002750-250
2.750	3.250	0.413	2.751	3.249	4615US25002750-375
2.750	3.500	0.413	2.752	3.498	4615US37502750-375
2.750	3.500	0.688	2.752	3.498	4615US37502750-625
3.000	3.375	0.413	3.001	3.374	4615US18703000-375
3.000	3.500	0.413	3.001	3.499	4615US25003000-375
3.125	3.500	0.413	3.126	3.499	4615US18703125-375
3.125	3.750	0.550	3.127	3.748	4615US31203125-500
3.250	3.750	0.413	3.251	3.749	4615US25003250-375
3.250	4.000	0.413	3.252	3.998	4615US37503250-375
3.250	4.000	0.481	3.252	3.998	4615US37503250-437
3.250	4.000	0.688	3.252	3.998	4615US37503250-625

\*If used with wear rings, refer to wear ring throat diameter, see Section 9.

\*\*If used with wear rings, refer to wear ring piston diameter, see Section 9.

For custom groove calculations, see Appendix C.

Table 6-14. US Gland Dimensions — Inch (Continued)

A	B	C	D		Part Number
Rod Diameter	(Rod) Groove Diameter	(Rod) Groove Width	Throat Diameter*	(Bore) Piston Diameter**	
(Bore) Groove Diameter	Bore Diameter	(Bore) Groove Width			
3.500	3.875	0.413	3.501	3.874	4615US18703500-375
3.500	4.000	0.413	3.501	3.999	4615US25003500-375
3.625	4.000	0.206	3.626	3.999	4615US18703625-187
3.625	4.000	0.275	3.626	3.999	4615US18703625-250
3.625	4.000	0.413	3.626	3.999	4615US18703625-375
3.750	4.250	0.413	3.751	4.249	4615US25003750-375
3.750	4.500	0.413	3.752	4.498	4615US37503750-375
3.875	4.500	0.550	3.877	4.498	4615US31203875-500
4.000	4.375	0.413	4.001	4.374	4615US18704000-375
4.000	4.500	0.413	4.001	4.499	4615US25004000-375
4.000	4.750	0.550	4.002	4.748	4615US37504000-500
4.000	4.750	0.688	4.002	4.748	4615US37504000-625
4.000	5.000	0.688	4.002	4.998	4615US50004000-625
4.250	4.750	0.618	4.251	4.749	4615US25004250-562
4.250	5.000	0.413	4.252	4.998	4615US37504250-375
4.250	5.000	0.550	4.252	4.998	4615US37504250-500
4.250	5.000	0.688	4.252	4.998	4615US37504250-625
4.250	5.500	0.825	4.253	5.497	4615US62504250-750
4.375	5.000	0.413	4.377	4.998	4615US31204375-375
4.375	5.000	0.618	4.377	4.998	4615US31204375-562
4.500	5.000	0.413	4.501	4.999	4615US25004500-375
4.500	5.000	0.618	4.501	4.999	4615US25004500-562
4.500	5.250	0.550	4.502	5.248	4615US37504500-500
4.750	5.000	0.206	4.751	4.999	4615US12504750-187
4.750	5.500	0.688	4.752	5.498	4615US37504750-625
5.000	5.375	0.413	5.001	5.374	4615US18705000-375
5.000	5.500	0.413	5.001	5.499	4615US25005000-375
5.000	5.750	0.550	5.002	5.748	4615US37505000-500
5.250	6.000	0.413	5.252	5.998	4615US37505250-375
5.250	6.500	0.825	5.253	6.497	4615US62505250-750
5.375	6.000	0.413	5.377	5.998	4615US31205375-375
5.375	6.000	0.656	5.377	5.998	4615US31205375-596
5.375	6.000	0.688	5.377	5.998	4615US31205375-625
5.500	5.875	0.413	5.501	5.874	4615US18705500-375
5.500	6.000	0.413	5.501	5.999	4615US25005500-375
5.750	6.250	0.618	5.751	6.249	4615US25005750-562
5.750	6.500	0.550	5.752	6.498	4615US37505750-500
6.000	6.500	0.618	6.001	6.499	4615US25006000-562

\*If used with wear rings, refer to wear ring throat diameter, see Section 9.

\*\*If used with wear rings, refer to wear ring piston diameter, see Section 9.

For custom groove calculations, see Appendix C.

**Table 6-14. US Gland Dimensions — Inch (Continued)**

A	B	C	D		Part Number
Rod Diameter	(Rod) Groove Diameter	(Rod) Groove Width	Throat Diameter*		
(Bore) Groove Diameter	Bore Diameter	(Bore) Groove Width		(Bore) Piston Diameter**	
6.250	7.000	0.413	6.252	6.998	<b>4615US37506250-375</b>
6.250	7.000	0.688	6.252	6.998	<b>4615US37506250-625</b>
6.500	7.000	0.618	6.501	6.999	<b>4615US25006500-562</b>
6.750	7.500	0.550	6.752	7.498	<b>4615US37506750-500</b>
7.000	8.000	0.825	7.002	7.998	<b>4615US50007000-750</b>
7.250	8.000	0.688	7.252	7.998	<b>4615US37507250-625</b>
7.375	8.000	0.343	7.377	7.998	<b>4615US31207375-312</b>
7.500	8.000	0.275	7.501	7.999	<b>4615US25007500-250</b>
7.500	8.000	0.618	7.501	7.999	<b>4615US25007500-562</b>
7.500	8.250	0.550	7.502	8.248	<b>4615US37507500-500</b>

\*If used with wear rings, refer to wear ring throat diameter, see Section 9.

\*\*If used with wear rings, refer to wear ring piston diameter, see Section 9.

For custom groove calculations, see Appendix C.

NOTE: For sizes larger than those shown in the table, please contact your local Parker Seal representative.



# Symmetrical Seals

## 8400 and 8500 Profiles

Catalog EPS 5370/USA

### 8400 Profile, Light Load U-cup with Beveled Lips; 8500 Profile, Light Load U-cup with Scraper Lips



Parker's 8400 and 8500 Series u-cups are symmetrical lip seals for use in either rod or piston sealing applications. The thin, flexible lip design reacts to low pressure and provides an extremely smooth, steady movement with less break away force required because of the inherent low friction. Both the 8400 and 8500 u-cups are produced from the same molds. The 8400 style utilizes a beveled lip, ideal for wiping fluid film, while the 8500 design utilizes a flat, scraper lip that yields additional lip interference and wipes contamination away from the sealing edge. Both u-cup profiles are available in a variety of rubber compounds to cover a wide range of applications. While the 8400 and 8500 u-cups are primarily designed for pneumatic applications, they can also be used in low to medium pressure hydraulic applications. The pressure range of the u-cups may be extended by incorporating an 8700 back-up ring.



8400 Cross-Section

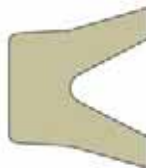

8500 Cross-Section

### Technical Data

Standard Materials*	Temperature Range	Pressure Range†	Surface Speed
N4180A80	-40°F to 250°F (-40°C to 121°C)	1,250 psi (86 bar)	< 1.6 ft/s (0.5 m/s)
N4274A85	-10°F to 250°F (-23°C to 121°C)	1,750 psi (120 bar)	< 1.6 ft/s (0.5 m/s)
V4208A90	-5°F to 400°F (-21°C to 204°C)	2,000 psi (137 bar)	< 1.6 ft/s (0.5 m/s)
E4259A80	-65°F to 300°F (-54°C to 149°C)	1,750 psi (120 bar)	< 1.6 ft/s (0.5 m/s)

\***Alternate Materials:** For applications that may require an alternate material, please contact your local Parker Seal representative.

†**Pressure Range** without wear rings (see Table 2-4, page 2-5).



8400 installed in Rod Gland

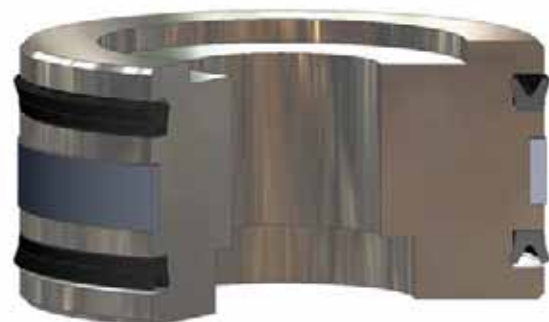

8400 installed in Piston Gland

## 8400 and 8500 Profiles

### Part Number Nomenclature — 8400 Profile

Table 6-15. 8400 Profile — Inch

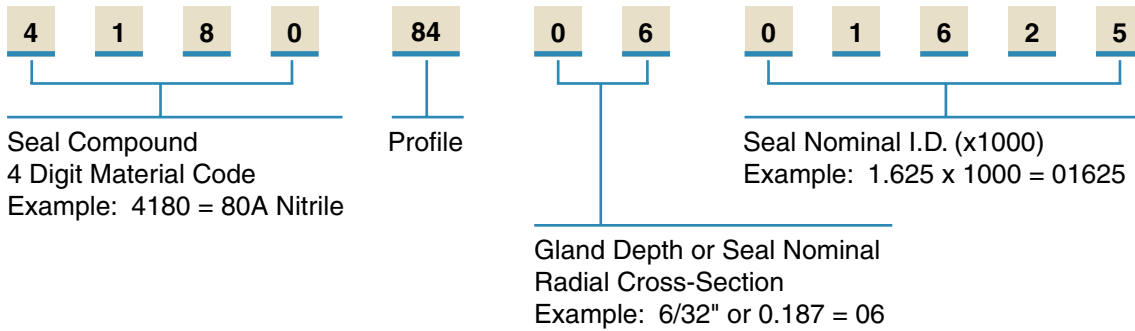

### Part Number Nomenclature — 8500 Profile

Table 6-16. 8500 Profile — Inch

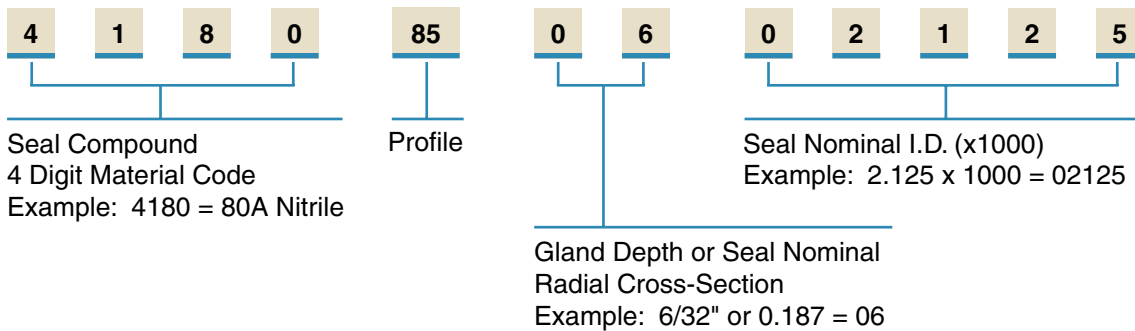

## Gland Dimensions — 8400 and 8500 Profiles

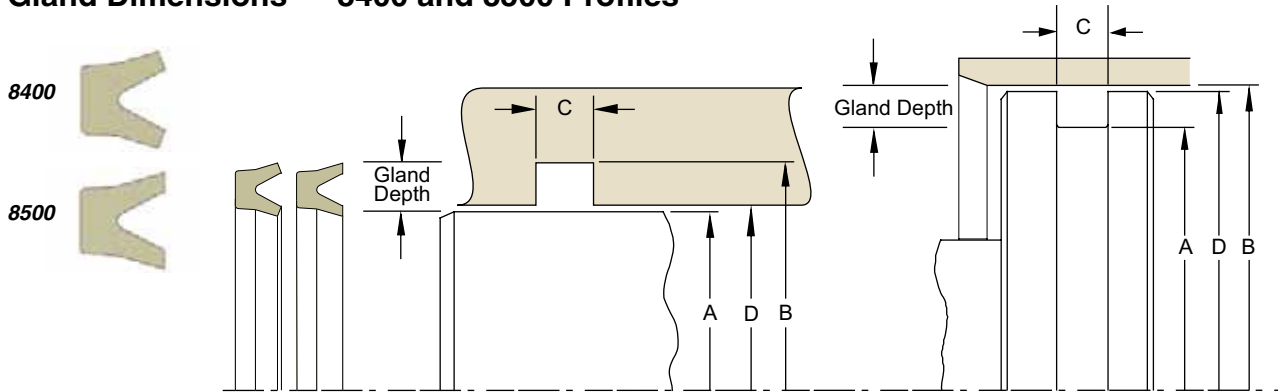

**Table 6-17A. Rod Gland Dimension Tolerances**

Nominal Gland Depth	A Rod Diameter	B Groove Diameter	C Groove Width	D Throat Diameter
1/8	+0.000/-0.001	+0.002/-0.000	+0.015/-0.000	+0.002/-0.000
3/16	+0.000/-0.002	+0.002/-0.000		+0.002/-0.000
1/4	+0.000/-0.002	+0.003/-0.000		+0.003/-0.000
5/16	+0.000/-0.002	+0.004/-0.000		+0.003/-0.000
3/8	+0.000/-0.002	+0.005/-0.000		+0.004/-0.000
7/16	+0.000/-0.003	+0.006/-0.000		+0.004/-0.000
1/2	+0.000/-0.003	+0.007/-0.000		+0.005/-0.000
5/8	+0.000/-0.003	+0.009/-0.000		+0.006/-0.000
3/4	+0.000/-0.004	+0.011/-0.000		+0.007/-0.000
1	+0.000/-0.005	+0.015/-0.000		+0.009/-0.000

**Table 6-17B. Piston Gland Dimension Tolerances**

Nominal Gland Depth	B Bore Diameter	A Groove Diameter	C Groove Width	D Piston Diameter
1/8	+0.002/-0.000	+0.000/-0.002	+0.015/-0.000	+0.000/-0.001
3/16	+0.002/-0.000	+0.000/-0.002		+0.000/-0.002
1/4	+0.003/-0.000	+0.000/-0.003		+0.000/-0.002
5/16	+0.003/-0.000	+0.000/-0.004		+0.000/-0.002
3/8	+0.004/-0.000	+0.000/-0.005		+0.000/-0.002
7/16	+0.005/-0.000	+0.000/-0.006		+0.000/-0.002
1/2	+0.005/-0.000	+0.000/-0.007		+0.000/-0.003
9/16	+0.006/-0.000	+0.000/-0.008		+0.000/-0.003
5/8	+0.006/-0.000	+0.000/-0.009		+0.000/-0.003
3/4	+0.007/-0.000	+0.000/-0.010		+0.000/-0.004
7/8	+0.008/-0.000	+0.000/-0.011	+0.000/-0.005	
1	+0.009/-0.000	+0.000/-0.012	+0.000/-0.005	

Please refer to Engineering Section 2, page 2-8 for surface finish and additional hardware considerations.

**Table 6-18. 8400 and 8500 Gland Dimensions — Inch**

A	B	C	D	E	Compound Code (X = Standard Offering)				Part Number		
Rod Diameter	(Rod) Groove Diameter	(Rod) Groove Width	Throat Diameter*		4180	4274	4208	4259	Compound Code	Profile Code 84 or 85	
(Bore) Groove Diameter	Bore Diameter	(Bore) Groove Width		(Bore) Piston Diameter**							
0.125	0.250	0.093	0.126	0.249	X	X	X	X	XXXX	8x	0200125
0.156	0.343	0.125	0.157	0.342			X		XXXX	8x	0300156
0.187	0.312	0.093	0.188	0.311	X	X	X	X	XXXX	8x	0200187
0.187	0.375	0.125	0.188	0.374	X	X	X	X	XXXX	8x	0300187
0.187	0.437	0.156	0.188	0.436		X	X	X	XXXX	8x	0400187
0.250	0.375	0.093	0.251	0.374	X	X	X	X	XXXX	8x	0200250
0.250	0.437	0.125	0.251	0.436	X	X	X		XXXX	8x	0300250
0.250	0.500	0.156	0.251	0.499		X	X	X	XXXX	8x	0400250
0.312	0.500	0.125	0.313	0.499	X	X	X	X	XXXX	8x	0300312
0.312	0.562	0.156	0.313	0.561	X	X	X	X	XXXX	8x	0400312

\*If used with wear rings, refer to wear ring throat diameter, see Section 9.  
 \*\*If used with wear rings, refer to wear ring piston diameter, see Section 9.  
 For custom groove calculations, see Appendix C.

**Table 6-18. 8400 and 8500 Gland Dimensions — Inch (Continued)**

A Rod Diameter	B (Rod) Groove Diameter	C (Rod) Groove Width	D Throat Diameter*	E (Bore) Piston Diameter**	Compound Code (X = Standard Offering)				Part Number		
					4180	4274	4208	4259	Compound Code	Profile Code 84 or 85	
0.375	0.500	0.093	0.376	0.499			X		XXXX	8x	0200375
0.375	0.625	0.156	0.376	0.624		X	X	X	XXXX	8x	0400375
0.437	0.687	0.156	0.438	0.686	X	X	X	X	XXXX	8x	0400437
0.500	0.750	0.156	0.501	0.749	X	X	X	X	XXXX	8x	0400500
0.562	0.812	0.156	0.563	0.811	X	X	X		XXXX	8x	0400562
0.625	0.812	0.125	0.626	0.811	X	X			XXXX	8x	0300625
0.625	0.875	0.156	0.626	0.874	X	X	X	X	XXXX	8x	0400625
0.687	0.937	0.156	0.688	0.936	X				XXXX	8x	0400687
0.687	1.000	0.188	0.688	0.999	X				XXXX	8x	0500687
0.750	1.000	0.156	0.751	0.999	X	X	X	X	XXXX	8x	0400750
0.750	1.125	0.218	0.751	1.124	X	X			XXXX	8x	0600750
0.812	1.062	0.156	0.813	1.061	X	X	X	X	XXXX	8x	0400812
0.875	1.125	0.156	0.876	1.124	X	X	X	X	XXXX	8x	0400875
0.875	1.250	0.218	0.876	1.249	X	X			XXXX	8x	0600875
0.937	1.187	0.156	0.938	1.186	X	X	X		XXXX	8x	0400937
0.937	1.250	0.188	0.938	1.249	X	X	X		XXXX	8x	0500937
1.000	1.250	0.156	1.001	1.249	X	X	X	X	XXXX	8x	0401000
1.000	1.312	0.188	1.001	1.311	X	X	X	X	XXXX	8x	0501000
1.000	1.375	0.218	1.002	1.374		X		X	XXXX	8x	0601000
1.000	1.500	0.281	1.001	1.499	X	X	X	X	XXXX	8x	0801000
1.062	1.375	0.188	1.063	1.374	X	X	X	X	XXXX	8x	0501062
1.125	1.375	0.156	1.126	1.374	X	X	X	X	XXXX	8x	0401125
1.125	1.437	0.188	1.126	1.436	X				XXXX	8x	0501125
1.187	1.500	0.188	1.188	1.499	X	X	X	X	XXXX	8x	0501187
1.250	1.500	0.156	1.251	1.499	X				XXXX	8x	0401250
1.250	1.562	0.188	1.251	1.561	X	X	X	X	XXXX	8x	0501250
1.312	1.625	0.188	1.313	1.624	X	X	X	X	XXXX	8x	0501312
1.375	1.687	0.188	1.376	1.686	X	X	X		XXXX	8x	0501375
1.375	1.750	0.218	1.377	1.749	X	X	X	X	XXXX	8x	0601375
1.437	1.750	0.188	1.438	1.749	X				XXXX	8x	0501437
1.500	1.812	0.188	1.501	1.811	X	X	X		XXXX	8x	0501500
1.500	1.875	0.218	1.502	1.874	X		X	X	XXXX	8x	0601500
1.625	2.000	0.218	1.627	1.999	X	X	X	X	XXXX	8x	0601625
1.687	2.062	0.218	1.689	2.061			X		XXXX	8x	0601687
1.750	2.000	0.156	1.751	1.999	X		X		XXXX	8x	0401750
1.750	2.125	0.218	1.752	2.124	X	X	X	X	XXXX	8x	0601750
1.875	2.250	0.218	1.877	2.249	X	X	X	X	XXXX	8x	0601875
1.937	2.375	0.250	1.938	2.374	X		X		XXXX	8x	0701937

\*If used with wear rings, refer to wear ring throat diameter, see Section 9.

\*\*If used with wear rings, refer to wear ring piston diameter, see Section 9.

For custom groove calculations, see Appendix C.

**Table 6-18. 8400 and 8500 Gland Dimensions — Inch (Continued)**

A Rod Diameter	B (Rod) Groove Diameter	C (Rod) Groove Width	D Throat Diameter*	E (Bore) Piston Diameter**	Compound Code (X = Standard Offering)				Part Number		
					4180	4274	4208	4259	Compound Code	Profile Code 84 or 85	
2.000	2.375	0.218	2.002	2.374	X	X	X	X	XXXX	8x	0602000
2.125	2.500	0.218	2.127	2.499	X	X	X	X	XXXX	8x	0602125
2.250	2.625	0.218	2.252	2.624	X	X	X		XXXX	8x	0602250
2.250	3.000	0.406	2.252	2.998	X				XXXX	8x	1202250
2.375	2.750	0.218	2.377	2.749	X	X	X		XXXX	8x	0602375
2.375	3.000	0.344	2.377	2.998	X	X			XXXX	8x	1002375
2.437	2.937	0.281	2.438	2.936		X			XXXX	8x	0802437
2.500	2.875	0.218	2.502	2.874	X	X	X	X	XXXX	8x	0602500
2.500	2.937	0.250	2.501	2.936	X	X	X	X	XXXX	8x	0702500
2.500	3.000	0.281	2.501	2.999	X				XXXX	8x	0802500
2.562	3.000	0.250	2.563	2.999	X	X	X	X	XXXX	8x	0702562
2.625	3.000	0.218	2.627	2.999	X		X	X	XXXX	8x	0602625
2.687	3.125	0.250	2.688	3.124	X				XXXX	8x	0702687
2.750	3.125	0.218	2.752	3.124	X		X	X	XXXX	8x	0602750
2.750	3.187	0.250	2.751	3.186	X				XXXX	8x	0702750
2.750	3.250	0.281	2.751	3.249	X				XXXX	8x	0802750
2.812	3.250	0.250	2.813	3.249	X	X	X		XXXX	8x	0702812
2.875	3.250	0.218	2.877	3.249	X				XXXX	8x	0602875
3.000	3.375	0.218	3.002	3.374	X	X	X	X	XXXX	8x	0603000
3.000	3.437	0.250	3.001	3.436	X	X	X	X	XXXX	8x	0703000
3.062	3.500	0.250	3.063	3.499	X	X	X	X	XXXX	8x	0703062
3.375	3.875	0.281	3.376	3.874	X				XXXX	8x	0803375
3.500	4.000	0.281	3.501	3.999	X	X	X	X	XXXX	8x	0803500
3.625	4.000	0.218	3.627	3.999	X				XXXX	8x	0603625
3.750	4.250	0.281	3.751	4.249	X	X	X		XXXX	8x	0803750
3.875	4.375	0.281	3.876	4.374		X			XXXX	8x	0803875
4.000	4.250	0.156	4.001	4.249	X				XXXX	8x	0404000
4.000	4.500	0.281	4.001	4.499	X		X	X	XXXX	8x	0804000
4.250	4.750	0.281	4.251	4.749	X	X	X		XXXX	8x	0804250
4.437	5.000	0.312	4.438	4.999	X	X	X	X	XXXX	8x	0904437
4.500	5.000	0.281	4.501	4.999	X	X	X	X	XXXX	8x	0804500
4.750	5.250	0.281	4.751	5.249	X		X		XXXX	8x	0804750
5.000	5.562	0.312	5.001	5.561	X	X	X		XXXX	8x	0905000
5.125	5.750	0.344	5.127	5.748	X				XXXX	8x	1005125
5.375	6.000	0.344	5.377	5.998	X	X	X	X	XXXX	8x	1005375
5.437	6.000	0.312	5.438	5.999	X	X	X	X	XXXX	8x	0905437
5.500	6.125	0.344	5.502	6.123	X	X	X	X	XXXX	8x	1005500
5.937	6.500	0.312	5.938	6.499	X	X			XXXX	8x	0905937

\*If used with wear rings, refer to wear ring throat diameter, see Section 9.  
 \*\*If used with wear rings, refer to wear ring piston diameter, see Section 9.  
 For custom groove calculations, see Appendix C.



**Table 6-18. 8400 and 8500 Gland Dimensions — Inch (Continued)**

A Rod Diameter	B (Rod) Groove Diameter	C (Rod) Groove Width	D Throat Diameter*	E (Bore) Piston Diameter**	Compound Code (X = Standard Offering)				Part Number		
					4180	4274	4208	4259	Compound Code	Profile Code 84 or 85	
6.000	6.625	0.344	6.002	6.623	X	X			XXXX	8x	1006000
6.375	7.000	0.344	6.377	6.998	X	X	X		XXXX	8x	1006375
6.437	7.000	0.312	6.438	6.999	X				XXXX	8x	0906437
6.969	7.593	0.344	6.971	7.591	X			X	XXXX	8x	1006969
7.000	7.625	0.344	7.002	7.623	X		X	X	XXXX	8x	1007000
7.375	8.000	0.344	7.377	7.998	X	X	X	X	XXXX	8x	1007375
7.750	8.375	0.344	7.752	8.373	X				XXXX	8x	1007750
8.500	9.125	0.344	8.502	9.123	X			X	XXXX	8x	1008500
9.000	9.750	0.406	9.002	9.748			X		XXXX	8x	1209000
9.312	10.000	0.375	9.314	9.998	X	X	X		XXXX	8x	1109312
11.000	11.750	0.406	11.002	11.748					XXXX	8x	1211000
11.000	12.000	0.531	11.002	11.998	X				XXXX	8x	1611000
11.250	12.000	0.406	11.252	11.998	X		X	X	XXXX	8x	1211250
13.000	14.000	0.531	13.002	13.998	X	X	X	X	XXXX	8x	1613000
13.187	14.000	0.437	13.189	13.998	X	X	X		XXXX	8x	1313187
17.125	18.000	0.469	17.127	17.998	X				XXXX	8x	1417125

\*If used with wear rings, refer to wear ring throat diameter, see Section 9.

\*\*If used with wear rings, refer to wear ring piston diameter, see Section 9.

For custom groove calculations, see Appendix C.

NOTE: For sizes larger than those shown in the table, please contact your local Parker Seal representative.



# Symmetrical Seal AN6226 Profile

Catalog EPS 5370/USA

## AN6226 Profile, Industrial, Standard, Light Load Rubber U-cups



Parker's AN6226 Style u-cups have a square format where the nominal cross section is equal to the height. Although widely used in the fluid power industry for low friction pneumatics, this profile was originally designed for early aircraft and ordnance service. Many units still use this type u-cup. The AN6226 profile is available in the most popular sizes and is made of a standard 70 Shore A nitrile compound.

### Technical Data

Standard Materials*	Temperature Range	Pressure Range†	Surface Speed
N4295A70	-40°F to 250°F (-40°C to 121°C)	800 psi (55 bar)	< 1.6 ft/s (0.5 m/s)

\***Alternate Materials:** For applications that may require an alternate material, please contact your local Parker Seal representative.

†**Pressure Range** without wear rings (see Table 2-4, page 2-5).

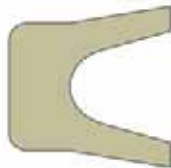

*AN6226 Cross-Section*

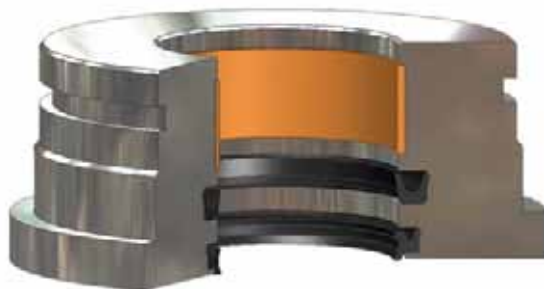

*AN6226 installed in Rod Gland*



*AN6226 installed in Piston Gland*

09/01/07

## AN6226 Profile

### Part Number Nomenclature — AN6226 Profile

Table 6-19. AN6226 Profile — Inch

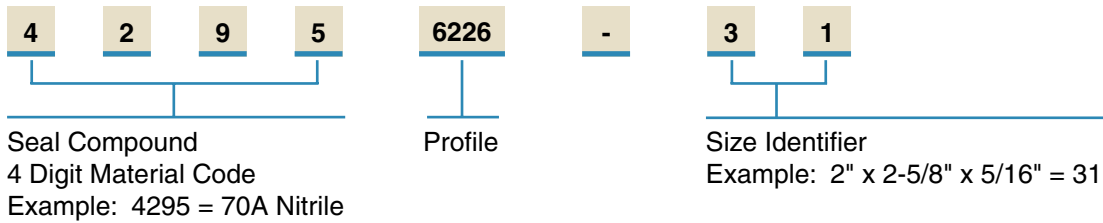

### Gland Dimensions — AN6226 Profile

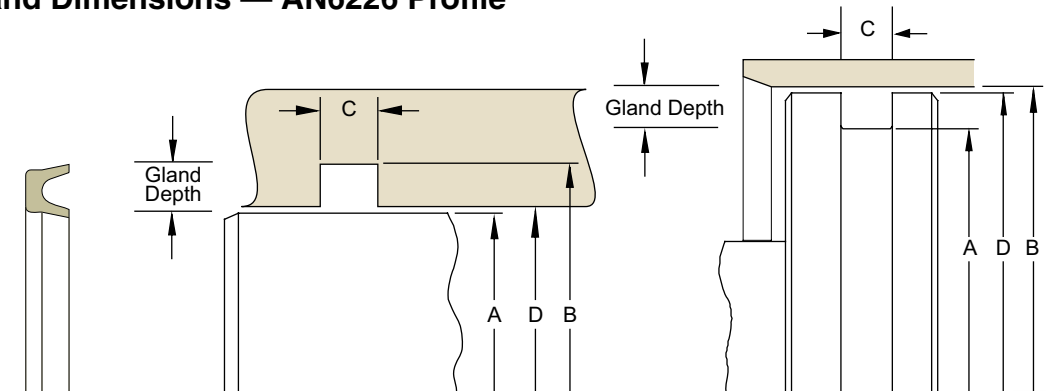

Table 6-20A. Rod Gland Dimension Tolerances

Nominal Gland Depth	A Rod Diameter	B Groove Diameter	C Groove Width	D Throat Diameter
1/8	+0.000/-0.001	+0.002/-0.000		+0.002/-0.000
3/16	+0.000/-0.001	+0.002/-0.000		+0.002/-0.000
1/4	+0.000/-0.002	+0.003/-0.000	+0.010/-0.010	+0.003/-0.000
5/16	+0.000/-0.002	+0.004/-0.000		+0.004/-0.000
3/8	+0.000/-0.002	+0.005/-0.000		+0.004/-0.000

Table 6-20B. Piston Gland Dimension Tolerances

Nominal Gland Depth	B Bore Diameter	A Groove Diameter	C Groove Width	D Piston Diameter
1/8	+0.003/-0.000	+0.000/-0.001		+0.000/-0.001
3/16	+0.003/-0.000	+0.000/-0.002		+0.000/-0.001
1/4	+0.003/-0.000	+0.000/-0.003	+0.010/-0.010	+0.000/-0.001
5/16	+0.003/-0.000	+0.000/-0.004		+0.000/-0.002
3/8	+0.004/-0.000	+0.000/-0.005		+0.000/-0.002

Please refer to Engineering Section 2, page 2-8 for surface finish and additional hardware considerations.

Table 6-21. AN6226 Gland Dimensions — Inch

A Rod Diameter	B (Rod) Groove Diameter	C (Rod) Groove Width	D Throat Diameter*	E (Bore) Piston Diameter**	Part Number
(Bore) Groove Diameter	Bore Diameter	(Bore) Groove Width			
0.125	0.500	0.218	0.126	0.498	42956226-01
0.187	0.562	0.218	0.188	0.560	42956226-02
0.250	0.625	0.218	0.251	0.623	42956226-03
0.312	0.687	0.218	0.313	0.685	42956226-04
0.375	0.750	0.218	0.376	0.748	42956226-05
0.437	0.812	0.218	0.438	0.810	42956226-06
0.500	0.875	0.218	0.501	0.873	42956226-07
0.250	0.750	0.281	0.251	0.748	42956226-08

\*If used with wear rings, refer to wear ring throat diameter, see Section 9.

\*\*If used with wear rings, refer to wear ring piston diameter, see Section 9.

For custom groove calculations, see Appendix C.

Table 6-21. AN6226 Gland Dimensions — Inch (Continued)

A	B	C	D	E	Part Number
Rod Diameter	(Rod) Groove Diameter	(Rod) Groove Width	Throat Diameter*		
(Bore) Groove Diameter	Bore Diameter	(Bore) Groove Width		(Bore) Piston Diameter**	
0.312	0.812	0.281	0.313	0.810	42956226-09
0.375	0.875	0.281	0.376	0.873	42956226-10
0.437	0.937	0.281	0.438	0.935	42956226-11
0.500	1.000	0.281	0.501	0.998	42956226-12
0.562	1.062	0.281	0.563	1.060	42956226-13
0.625	1.125	0.281	0.626	1.123	42956226-14
0.687	1.187	0.281	0.688	1.185	42956226-15
0.750	1.250	0.281	0.751	1.248	42956226-16
0.812	1.312	0.281	0.813	1.310	42956226-17
0.875	1.375	0.281	0.876	1.373	42956226-18
0.937	1.437	0.281	0.938	1.435	42956226-19
1.000	1.500	0.281	1.001	1.498	42956226-20
1.062	1.562	0.281	1.063	1.560	42956226-21
1.125	1.625	0.281	1.126	1.623	42956226-22
1.187	1.687	0.281	1.188	1.685	42956226-23
1.250	1.750	0.281	1.251	1.748	42956226-24
1.250	1.875	0.344	1.252	1.873	42956226-25
1.375	2.000	0.344	1.377	1.998	42956226-26
1.500	2.125	0.344	1.502	2.123	42956226-27
1.625	2.250	0.344	1.627	2.248	42956226-28
1.750	2.375	0.344	1.752	2.373	42956226-29
1.875	2.500	0.344	1.877	2.498	42956226-30
2.000	2.625	0.344	2.002	2.623	42956226-31
2.125	2.750	0.344	2.127	2.748	42956226-32
2.250	2.875	0.344	2.252	2.873	42956226-33
2.375	3.000	0.344	2.377	2.998	42956226-34
2.500	3.125	0.344	2.502	3.123	42956226-35
2.500	3.250	0.406	2.502	3.248	42956226-36
2.625	3.375	0.406	2.627	3.373	42956226-37
2.750	3.500	0.406	2.752	3.498	42956226-38
2.875	3.625	0.406	2.877	3.623	42956226-39
3.000	3.750	0.406	3.002	3.748	42956226-40
0.125	0.375	0.156	0.126	0.373	42956226-41
0.187	0.437	0.156	0.188	0.435	42956226-42
0.250	0.500	0.156	0.251	0.498	42956226-43
0.312	0.562	0.156	0.313	0.560	42956226-44
0.375	0.625	0.156	0.376	0.623	42956226-45
0.437	0.687	0.156	0.438	0.685	42956226-46
0.500	0.750	0.156	0.501	0.748	42956226-47
0.625	1.000	0.218	0.626	0.998	42956226-48

\*If used with wear rings, refer to wear ring throat diameter, see Section 9.

\*\*If used with wear rings, refer to wear ring piston diameter, see Section 9.

For custom groove calculations, see Appendix C.

09/01/07



**Table 6-21. AN6226 Gland Dimensions — Inch (Continued)**

A	B	C	D	E	Part Number
Rod Diameter	(Rod) Groove Diameter	(Rod) Groove Width	Throat Diameter*		
(Bore) Groove Diameter	Bore Diameter	(Bore) Groove Width		(Bore) Piston Diameter**	
0.750	1.125	0.218	0.751	1.123	<b>42956226-49</b>
0.875	1.250	0.218	0.876	1.248	<b>42956226-50</b>
1.000	1.375	0.218	1.001	1.373	<b>42956226-51</b>
1.125	1.500	0.218	1.126	1.498	<b>42956226-52</b>
1.250	1.625	0.218	1.251	1.623	<b>42956226-53</b>

\*If used with wear rings, refer to wear ring throat diameter, see Section 9.

\*\*If used with wear rings, refer to wear ring piston diameter, see Section 9.

For custom groove calculations, see Appendix C.

NOTE: For sizes larger than those shown in the table, please contact your local Parker Seal representative.

# Symmetrical Seal Spiral Vee Profile

Catalog EPS 5370/USA

## Spiral Vee Rings, Cut to Size Chevron Packing



Parker Spiral Vee rings are precision formed rubber and combination rubber/fabric sealing products designed to protect equipment from leakage and costly down time. Parker Spiral Vee rings are designed to work in combination with adapters and shims. Adapters, which typically consist of rubber and plastic rings, are fitted to the top and/or bottom of the Vee ring stack to enhance sealing performance and prohibit extrusion. Rectangular cross-section discs, or “shims,” are used to adjust the height of the Vee ring stack set to pre-existing groove depths. Spiral Vee rings, adapters and shims are engineered for use in rams and plungers, presses, forging hammers and other hydraulic applications. Also included are refuse trucks and telescoping systems that require consistent, cost-effective sealing. These products contribute to the safe and reliable operation of equipment in chemical processing, energy/oilfield and other industries. To ensure compatibility with the many organic (petroleum-based) and synthetic fluids used in hydraulic applications, Parker offers its Spiral Vee ring products, adapters and shims in a wide range of compounds.



*Spiral Vee Cross-Section*



*Spiral Vee installed in Rod Gland*



*Spiral Vee installed in Piston Gland*

09/01/07

## Spiral Vee Profile

### Technical Data — Materials Matrix\*†

Table 6-22. Material Codes

Vee Set Material Code	Adapters		Middle Rings	
	Description	Temperature Rating	Description	Temperature Rating
4050	Fabric/Neoprene	-45°F to 250°F (-43°C to 121°C)	Fabric/Neoprene	-45°F to 250°F (-43°C to 121°C)
4051	Fabric/Neoprene	-45°F to 250°F (-43°C to 121°C)	Fabric/Neoprene/ Homogeneous NBR	-45°F to 250°F (-43°C to 121°C)
4052	Fabric/Neoprene	-45°F to 250°F (-43°C to 121°C)	Nitrile	-30°F to 250°F (-34°C to 121°C)
4053	Fabric/FKM	-25°F to 450°F (-32°C to 232°C)	Fabric/FKM	-25°F to 450°F (-32°C to 232°C)
4054	Fabric/FKM	-25°F to 450°F (-32°C to 232°C)	Fabric/FKM/ Homogeneous FKM	-25°F to 450°F (-32°C to 232°C)
4055	Fabric/FKM	-25°F to 450°F (-32°C to 232°C)	FKM	-25°F to 450°F (-32°C to 232°C)

\***Note:** Independent of Material Codes in Section 3.

†**Alternate Materials:** For applications that may require an alternate material, please contact your local Parker Seal representative.

Table 6-23. Recommended Number of Middle Rings (Vees) per Set Based on Pressure

	Pressure			
	Up to 1,000 psi	1,000 to 2,000 psi	2,000 to 4,000 psi	4,000 to 6,000 psi
Minimum Number of Rings	3	4	5	6



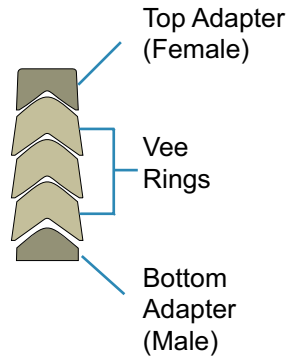

**Part Number Nomenclature — Spiral Vee Profile**

Table 6-24. Spiral Vee Profile — Inch

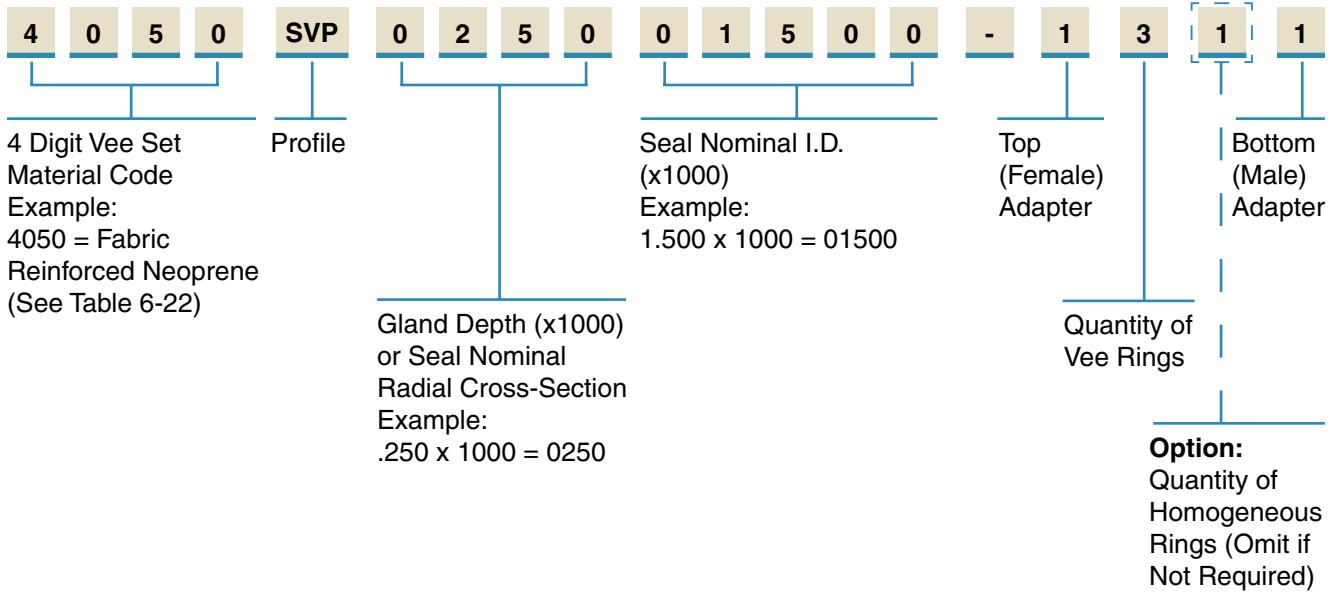

**Steps in developing Spiral Vee part number:**

- 1) Identify the material combination for the V-Packing Set from the material matrix.
- 2) SVP – Spiral V-Packing line callout.
- 3) Identify the nominal cross-section (0250 = .250").
- 4) Identify the nominal inner diameter (01500 = 1.50").

- 5) Identify the number and type of rings in the set:
  - a) First digit is the number of top adapters (1 or 0).
  - b) Second digit is the number of vees (as shown "3" = 3 vees).
  - c) Number of homogeneous rubber vee rings. Omit if not required.
  - d) Third digit is the number of bottom adapters (1 or 0).

## Spiral Vee Profile

### Bulk Length Availability — Spiral Vee Profile

Table 6-25. Spiral Vee Profile — Inch

Cross Section	Feet/ Spiral	I.D./ Range	Mandrel Sizes Available			
			I.D.	6"	10"	16"
0.375"	49'	I.D.	6"	10"	16"	20"
		Range	4"-8"	8.1"-14"	14.1"-21"	21.1"+
0.500"	46'	I.D.	6"	12"	16"	20"
		Range	5"-10"	10.1"-16"	16.1"-23"	23.1"+
0.625"	62'	I.D.	6"	12"	18"	20"
		Range	6"-11"	11.1"-17"	17.1"-22"	22.1"+
0.750"	62'	I.D.	10"	12"	18"	20"
		Range	9"-12"	12.1"-16"	16.1-23"	23.1"+
.0875"	62'	I.D.		12"	16"	20"
		Range		11"-15"	15.1"-23"	23.1"+
1.000"	62'	I.D.			16"	20"
		Range			14"-23"	23.1"+

Contact your local Parker Seal representative for price and availability of bulk length Spiral Vee.

### Stack Height Calculation — Spiral Vee Profile

Table 6-26. Spiral Vee Dimensions — Inch

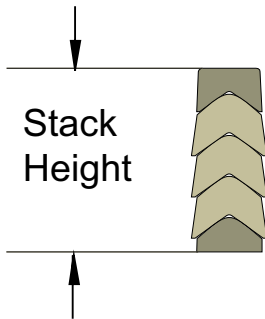

Cross-Section	Stack Height for Each Vee Ring		Height of Combined Top and Bottom Adapters	
	Inches	Tolerance	Inches	Tolerance
0.375	0.220	±0.025	0.480	±0.030
0.500	0.300	±0.025	0.530	±0.030
0.625	0.370	±0.030	0.625	±0.030
0.750	0.405	±0.030	0.690	±0.030
0.875	0.500	±0.030	0.740	±0.030
1.000	0.540	±0.030	0.780	±0.030

NOTE: For sizes larger than those shown in the table, please contact your local Parker Seal representative.

$$\text{Stack Height} = \left( [\text{number of middle rings (Vees)}] \times [\text{stack height for each vee ring (see Table 6-26)}] \right) + [\text{height of combined top and bottom adapters (see Table 6-26)}]$$

**Example:** 1-3-1 Vee Stack with 0.500" cross-section

$$\begin{aligned} \text{Stack Height} &= ( [3] \times [.300] ) \\ &\quad ([\text{number of middle rings (Vees)}] \times [\text{stack height for each vee ring (see Table 6-26)}]) \\ &+ [.530] \\ &\quad + [\text{height of combined top and bottom adapters (see Table 6-26)}] \\ &= 1.430" \end{aligned}$$

## Contents

Product Offering .....	7-2
Decision Tree .....	7-3
Piston Seal Profiles	
BP .....	7-5
PSP .....	7-8
CC .....	7-11
OK .....	7-13
PIP.....	7-15
B7 .....	7-19
UP .....	7-23
E4 .....	7-26
BMP.....	7-29
TP .....	7-31
S5 .....	7-35
R5 .....	7-39
CT .....	7-43
CQ.....	7-48
OE .....	7-53
CP .....	7-62
OA .....	7-68
OQ.....	7-74

## Piston Seal Profiles

Parker offers the most comprehensive range of piston seals in the market today. A variety of profiles such as lip seals, cap seals and squeeze seals are manufactured from proprietary rubber, thermoplastic and PTFE compounds to meet the broad demands of the fluid power industry. The highest quality materials and manufacturing processes are utilized to ensure the best performance possible. Parker's piston seal profiles are available for both uni-directional and bi-directional applications. When combined with wear rings, Parker piston seals have proven to provide long life and leak free performance.











































# Piston Seal Product Offering

Catalog EPS 5370/USA

## Profiles

Table 7-1: Product Profiles

Series	Description	Application (Duty)				Page	Series	Description	Application (Duty)				Page
		Light	Medium	Heavy	Pneumatic				Light	Medium	Heavy	Pneumatic	
BP	Premium TPU Cap Seal					7-5	TP	Compact Seal with Anti-Extrusion Technology					7-31
PSP	TPU Piston Cap Seal					7-8	S5	Square PTFE Cap Seal					7-35
CC	High Pressure, Step Cut Cap Piston Seal					7-11	R5	Rectangular PTFE Cap Seal					7-39
OK	High Pressure, Step Cut Cap Piston Seal					7-13	CT	Premium PTFE Cap Seal with Anti-Extrusion Technology					7-43
PIP	Loaded Lip Seal with Pressure Inverting Pedestal					7-15	CQ	Premium PTFE Cap Seal with Anti-Drift Technology					7-48
B7	U-cup Piston Seal					7-19	OE	PTFE Piston Cap Seal					7-53
UP	Industrial U-cup Piston Seal					7-23	CP	PTFE Piston Cap Seal to Retrofit O-ring Gland					7-62
E4	Premium Rounded Lip U-cup Piston Seal					7-26	OA	Compact PTFE Piston Cap Seal					7-68
BMP	Rounded Lip Seal with Bumper Cushion					7-29	OQ	Rotary PTFE Cap Seal					7-74

09/01/07



# Piston Seal Decision Tree

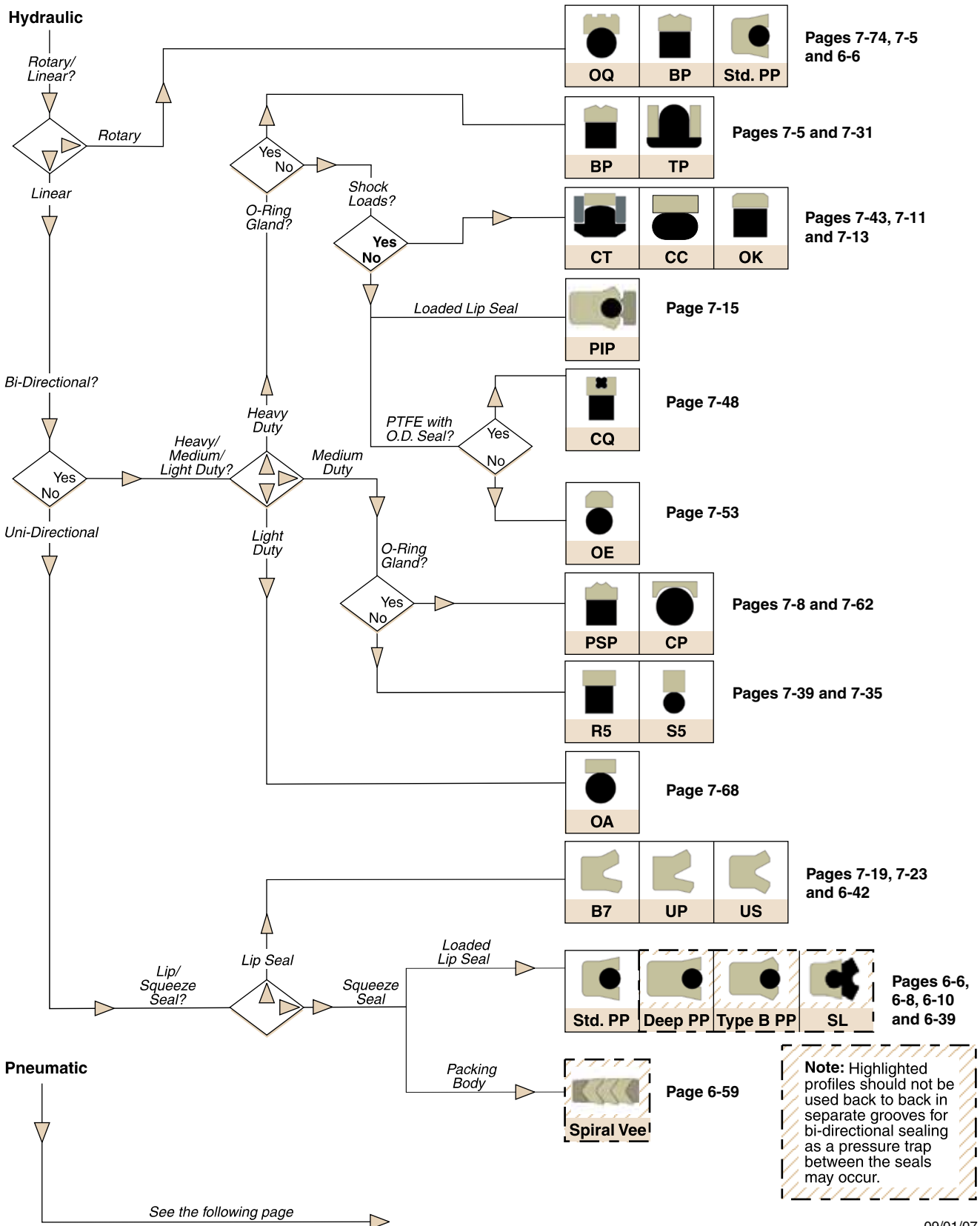

# Piston Seals

## Piston Seal Decision Tree (Continued)

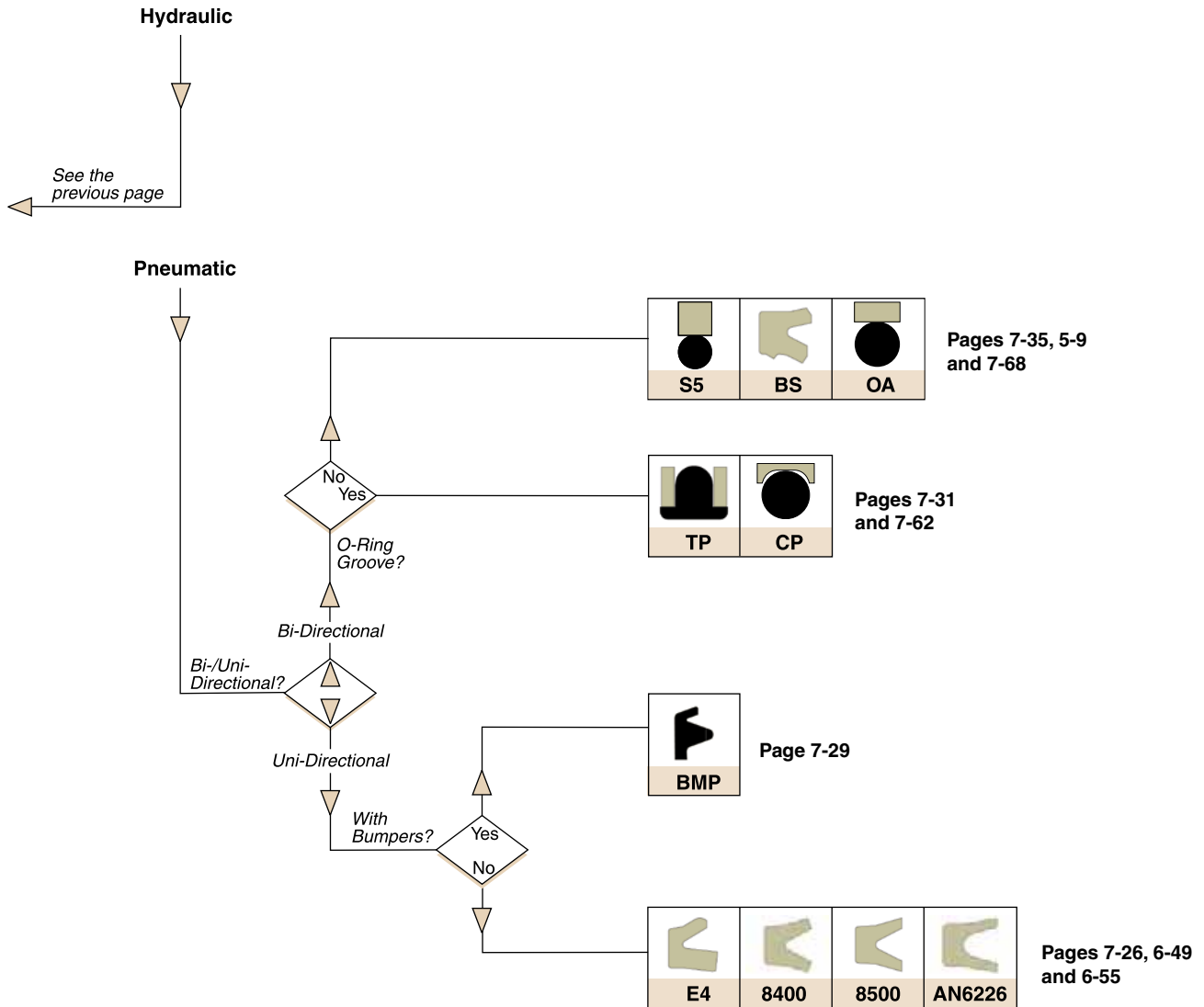

7



# Piston Seal BP Profile

Catalog EPS 5370/USA



## BP Profile, Premium TPU Cap Seal

Parker's BP profile is a squeeze type, bi-directional piston seal for use in medium to heavy duty hydraulic applications. This seal is primarily designed for linear applications but has been successfully used as a low speed rotary seal. The standard material for this profile is Resilon ER, compound P4304. This is a proprietary Parker polyurethane offering higher wear resistance, extrusion resistance, and extended temperature range. The Resilon ER cap is energized using a resilient nitrile elastomer offering low compression set. The BP seal's geometry provides a fluid reservoir between the two sealing lips which holds system fluid, resulting in reduced breakaway and running friction. The BP is offered in two styles, standard and narrow, with the standard style designed to retrofit o-ring grooves. The BP profile is easy to install and will resist rolling and twisting in long stroke applications.

The BP profile is sold only as an assembly (seal and energizer). See part number nomenclature.

### Technical Data

Standard Materials*	Temperature Range	Pressure Range†	Surface Speed
<b>Cap</b> P4304D60	-65°F to 275°F (-54°C to 135°C)	7,000 psi (482 bar)	< 1.6 ft/s (0.5 m/sec)
<b>Energizer</b> A 70A Nitrile	-30°F to 250°F (-34°C to 121°C)		

\***Alternate Materials:** For applications that may require an alternate material, please contact your local Parker Seal representative.

†**Pressure Range** without wear rings (see Table 2-4, page 2-5).

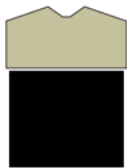

BP Cross-Section



BP installed in Piston Gland



09/01/07

**BP Profile**

**Part Number Nomenclature — BP (Standard Style) Profile**

**Table 7-2. BP (Standard Style) Profile — Inch**

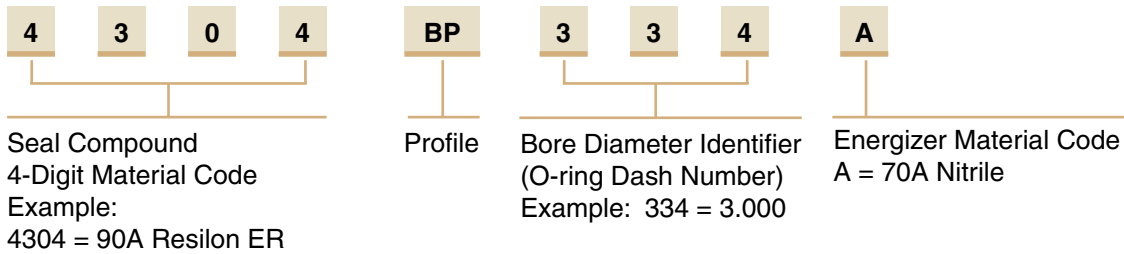

**Gland Dimensions — BP Profile**

Please refer to Engineering Section 2, Page 2-8 for surface finish and additional hardware considerations.

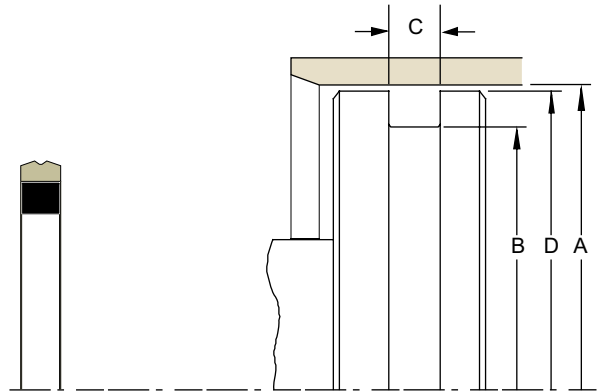

**Table 7-3. BP Gland Dimensions (Standard Size)**

A Bore Diameter	B Groove Diameter	C Groove Width	D Piston Diameter*	Part Number
+.002/ -.000	+.000/ -.002	+.005/ -.000	+.000/ -.001	
0.562	0.320	0.187	0.559	<b>4304BP203A</b>
0.625	0.383	0.187	0.662	<b>4304BP204A</b>
0.687	0.445	0.187	0.684	<b>4304BP205A</b>
0.750	0.508	0.187	0.747	<b>4304BP206A</b>
0.812	0.570	0.187	0.809	<b>4304BP207A</b>
0.875	0.633	0.187	0.872	<b>4304BP208A</b>
0.937	0.695	0.187	0.934	<b>4304BP209A</b>
1.000	0.758	0.187	0.997	<b>4304BP210A</b>
1.062	0.820	0.187	1.059	<b>4304BP211A</b>
1.125	0.833	0.187	1.122	<b>4304BP212A</b>
1.187	0.945	0.187	1.184	<b>4304BP213A</b>
1.250	1.008	0.187	1.247	<b>4304BP214A</b>
1.312	1.070	0.187	1.309	<b>4304BP215A</b>
1.375	1.133	0.187	1.372	<b>4304BP216A</b>
1.437	1.195	0.187	1.434	<b>4304BP217A</b>
1.500	1.258	0.187	1.497	<b>4304BP218A</b>
1.562	1.320	0.187	1.559	<b>4304BP219A</b>
1.625	1.383	0.187	1.622	<b>4304BP220A</b>
1.687	1.445	0.187	1.684	<b>4304BP221A</b>
1.750	1.508	0.187	1.747	<b>4304BP222A</b>
1.875	1.505	0.281	1.872	<b>4304BP325A</b>
2.000	1.630	0.281	1.997	<b>4304BP326A</b>
2.125	1.755	0.281	2.122	<b>4304BP327A</b>
2.250	1.880	0.281	2.247	<b>4304BP328A</b>

\*If used with wear rings, refer to wear ring piston diameter, see Section 9.

A Bore Diameter	B Groove Diameter	C Groove Width	D Piston Diameter*	Part Number
+.002/ -.000	+.000/ -.002	+.005/ -.000	+.000/ -.001	
2.375	2.005	0.281	2.372	<b>4304BP329A</b>
2.500	2.130	0.281	2.497	<b>4304BP330A</b>
2.625	2.255	0.281	2.622	<b>4304BP331A</b>
2.750	2.380	0.281	2.747	<b>4304BP332A</b>
2.875	2.505	0.281	2.872	<b>4304BP333A</b>
3.000	2.630	0.281	2.997	<b>4304BP334A</b>
3.125	2.755	0.281	3.122	<b>4304BP335A</b>
3.250	2.880	0.281	3.247	<b>4304BP336A</b>
3.375	3.005	0.281	3.372	<b>4304BP337A</b>
3.500	3.130	0.281	3.497	<b>4304BP338A</b>
3.625	3.255	0.281	3.622	<b>4304BP339A</b>
3.750	3.380	0.281	3.747	<b>4304BP340A</b>
3.875	3.505	0.281	3.872	<b>4304BP341A</b>
4.000	3.630	0.281	3.997	<b>4304BP342A</b>
4.125	3.755	0.281	4.122	<b>4304BP343A</b>
4.250	3.880	0.281	4.247	<b>4304BP344A</b>
4.375	4.005	0.281	4.372	<b>4304BP345A</b>
4.500	4.130	0.281	4.497	<b>4304BP346A</b>
4.625	4.255	0.281	4.622	<b>4304BP347A</b>
4.750	4.380	0.281	4.747	<b>4304BP348A</b>
4.875	4.505	0.281	4.872	<b>4304BP349A</b>
5.002	4.630	0.281	4.997	<b>4304BP350A</b>
5.127	4.653	0.375	5.123	<b>4304BP426A</b>
5.252	4.778	0.375	5.248	<b>4304BP427A</b>

\*If used with wear rings, refer to wear ring piston diameter, see Section 9.

**Table 7-3. BP Gland Dimensions — Inch (Continued)**

A Bore Diameter	B Groove Diameter	C Groove Width	D Piston Diameter*	Part Number
+0.002/ -.000	+0.000/ -.002	+0.005/ -.000	+0.000/ -.001	
5.377	4.903	0.375	5.373	<b>4304BP428A</b>
5.502	5.028	0.375	5.498	<b>4304BP429A</b>
5.627	5.153	0.375	5.623	<b>4304BP430A</b>
5.752	5.278	0.375	5.748	<b>4304BP431A</b>
5.877	5.403	0.375	5.873	<b>4304BP432A</b>
6.002	5.528	0.375	5.998	<b>4304BP433A</b>

A Bore Diameter	B Groove Diameter	C Groove Width	D Piston Diameter*	Part Number
+0.002/ -.000	+0.000/ -.002	+0.005/ -.000	+0.000/ -.001	
6.127	5.653	0.375	6.123	<b>4304BP434A</b>
6.252	5.778	0.375	6.248	<b>4304BP435A</b>
6.502	6.028	0.375	6.498	<b>4304BP437A</b>
6.752	6.278	0.375	6.748	<b>4304BP438A</b>
7.002	6.528	0.375	6.998	<b>4304BP439A</b>

\*If used with wear rings, refer to wear ring piston diameter, see Section 9.

\*If used with wear rings, refer to wear ring piston diameter, see Section 9.

NOTE: For sizes larger than those shown in the table, please contact your local Parker Seal representative.

**Part Number Nomenclature — BP (Narrow Style) Profile**

**Table 7-4. BP (Narrow Style) Profile — Inch**

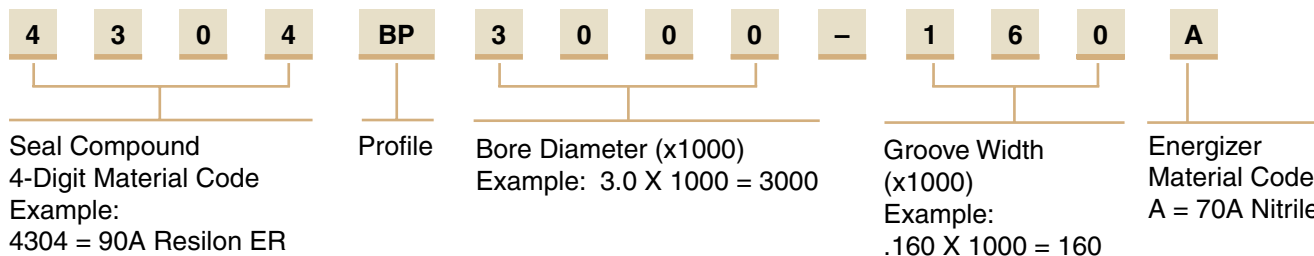

**Gland Dimensions — BP Profile**

Please refer to Engineering Section 2, Page 2-8 for surface finish and additional hardware considerations.

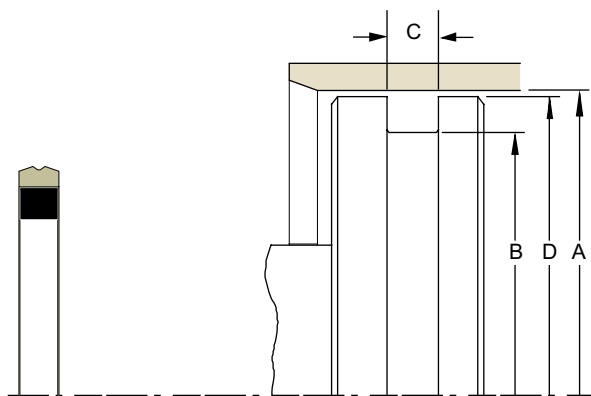

**Table 7-5. BP Gland Dimensions (Narrow Size)**

A Bore Diameter	B Groove Diameter	C Groove Width	D Piston Diameter*	Part Number
+0.002/ -.000	+0.000/ -.002	+0.002/ -.000	+0.000/ -.001	
1.750	1.473	0.130	1.747	<b>4304BP1750-130A</b>
2.000	1.582	0.175	1.997	<b>4304BP2000-175A</b>
2.250	1.973	0.130	2.247	<b>4304BP2250-130A</b>
2.500	2.223	0.130	2.497	<b>4304BP2500-130A</b>
2.500	2.082	0.175	2.497	<b>4304BP2500-175A</b>
2.750	2.348	0.160	2.747	<b>4304BP2750-160A</b>
3.000	2.598	0.160	2.997	<b>4304BP3000-160A</b>

A Bore Diameter	B Groove Diameter	C Groove Width	D Piston Diameter*	Part Number
+0.002/ -.000	+0.000/ -.002	+0.002/ -.000	+0.000/ -.001	
3.250	2.848	0.160	3.247	<b>4304BP3250-160A</b>
3.500	3.098	0.160	3.497	<b>4304BP3500-160A</b>
3.750	3.348	0.160	3.747	<b>4304BP3750-160A</b>
4.000	3.598	0.160	3.997	<b>4304BP4000-160A</b>
4.250	3.848	0.160	4.247	<b>4304BP4250-160A</b>
4.500	4.098	0.160	4.497	<b>4304BP4500-160A</b>
5.000	4.598	0.160	4.997	<b>4304BP5000-160A</b>

\*If used with wear rings, refer to wear ring piston diameter, see Section 9.

\*If used with wear rings, refer to wear ring piston diameter, see Section 9.

NOTE: For sizes larger than those shown in the table, please contact your local Parker Seal representative.

# Piston Seal PSP Profile

Catalog EPS 5370/USA



## PSP Profile, TPU Piston Cap Seal

Parker's PSP seal is a squeeze type, bi-directional piston seal for use in light to medium duty hydraulic applications. Available from proprietary Parker polyurethanes, the PSP offers low friction, abrasion and extrusion resistance. The nitrile elastomer energizer ensures resistance to compression set to increase seal life. The PSP seal's geometry provides a fluid reservoir between the two sealing lips which holds system fluid, resulting in reduced breakaway and running friction. Designed to retrofit grooves for a single o-ring or an o-ring with two back-ups, the PSP profile is easy to install and resist rolling and twisting in long stroke applications.

The PSP profile is sold only as an assembly (seal and energizer). See part number nomenclature.

### Technical Data

Standard Materials* Cap	Temperature Range	Pressure Range†	Surface Speed
P4622A90	-65°F to 225°F (-54°C to 107°C)	5000 psi (344 bar)	< 1.6 ft/s (0.5 m/sec)
P4300A90	-65°F to 275°F (-54°C to 135°C)	5000 psi (344 bar)	< 1.6 ft/s (0.5 m/sec)
<b>Energizer</b>			
A 70A Nitrile	-30°F to 250°F (-34°C to 121°C)		

\***Alternate Materials:** For applications that may require an alternate material, please contact your local Parker Seal representative.

†**Pressure Range** without wear rings (see Table 2-4, page 2-5).



PSP Cross-Section

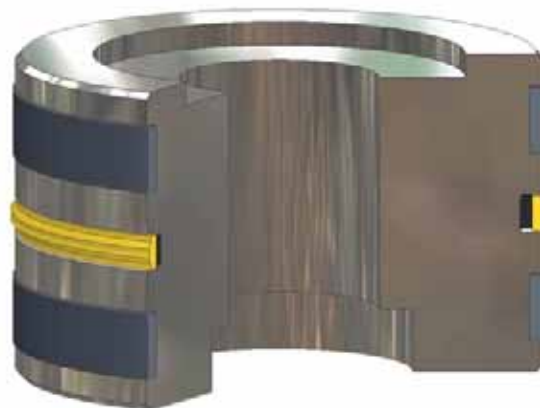

PSP installed in Piston Gland

09/01/07

**Part Number Nomenclature — PSP Profile**

Table 7-6. PSP Profile — Inch

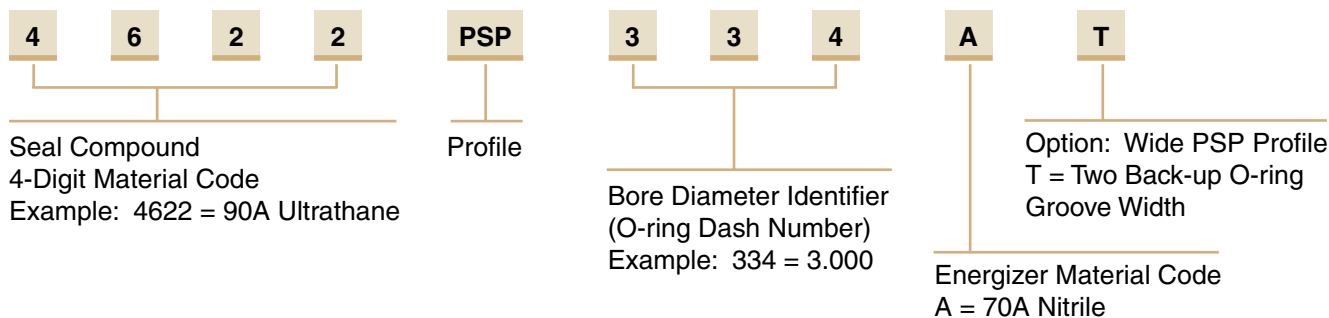

**Gland Dimensions — PSP Profile**

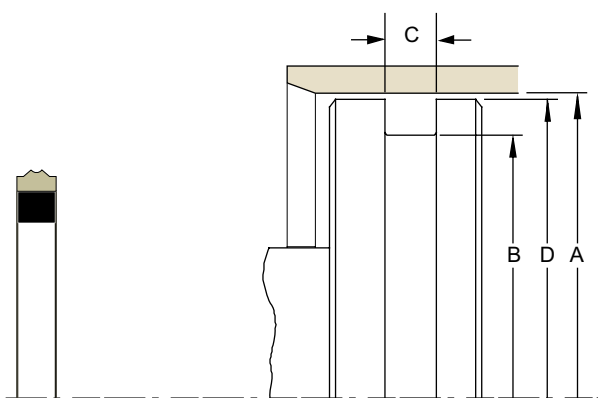

Please refer to Engineering Section 2, Page 2-8 for surface finish and additional hardware considerations.

Table 7-7. PSP Gland Dimensions

A Bore Diameter	B Groove Diameter	C Groove Width	D Piston Diameter*	Compound (X = Standard Offering)			Part Number	
				PSP		Wide PSP	Compound Code	
				4622	4300	4300		
<b>+0.002/-0.000</b>	<b>+0.000/-0.002</b>	<b>+0.005/-0.000</b>	<b>+0.000/-0.001</b>					
0.625	0.383	0.187	0.662		X		XXXX	PSP204A
0.750	0.508	0.187	0.747		X		XXXX	PSP206A
1.000	0.758	0.187	0.997	X	X		XXXX	PSP210A
1.250	1.008	0.187	1.247	X	X		XXXX	PSP214A
1.500	1.258	0.187	1.497	X	X		XXXX	PSP218A
1.500	1.258	0.275	1.497			X	XXXX	PSP218AT
1.750	1.508	0.187	1.747	X			XXXX	PSP222A
1.750	1.508	0.275	1.747			X	XXXX	PSP222AT
1.875	1.633	0.187	1.872		X		XXXX	PSP223A
2.125	1.833	0.187	2.122		X		XXXX	PSP225A
2.250	2.008	0.187	2.247		X		XXXX	PSP226A
1.875	1.505	0.281	1.872				XXXX	PSP325A
2.000	1.630	0.281	1.997	X	X		XXXX	PSP326A
2.000	1.630	0.410	1.997			X	XXXX	PSP326AT
2.250	1.880	0.281	2.247	X	X		XXXX	PSP328A
2.500	2.130	0.281	2.497	X	X		XXXX	PSP330A
2.500	2.130	0.410	2.497			X	XXXX	PSP330AT
2.625	2.255	0.281	2.622		X		XXXX	PSP331A
2.750	2.380	0.281	2.747	X	X		XXXX	PSP332A
3.000	2.630	0.281	2.997	X	X		XXXX	PSP334A

\*If used with wear rings, refer to wear ring piston diameter, see Section 9.



**PSP Profile****Table 7-7. PSP Gland Dimensions — Inch (Continued)**

A Bore Diameter	B Groove Diameter	C Groove Width	D Piston Diameter*	Compound (X = Standard Offering)			Part Number	
				PSP		Wide PSP	Compound Code	
				4622	4300	4300		
<b>+.002/-0.000</b>	<b>+.000/-0.002</b>	<b>+.005/-0.000</b>	<b>+.000/-0.001</b>					
3.000	2.630	0.410	2.997			X	XXXX	PSP334AT
3.125	2.755	0.281	3.122		X		XXXX	PSP335A
3.250	2.880	0.281	3.247	X	X		XXXX	PSP336A
3.500	3.130	0.281	3.497	X	X		XXXX	PSP338A
3.500	3.130	0.410	3.497			X	XXXX	PSP338AT
3.625	3.255	0.281	3.622	X			XXXX	PSP339A
4.000	3.630	0.281	3.997	X	X		XXXX	PSP342A
4.000	3.630	0.410	3.997			X	XXXX	PSP342AT
4.500	4.130	0.281	4.497	X			XXXX	PSP346A
4.500	4.130	0.410	4.497			X	XXXX	PSP346AT
5.002	4.630	0.281	4.997	X			XXXX	PSP350A
5.002	4.528	0.538	4.997			X	XXXX	PSP425AT
5.502	5.028	0.375	5.498	X			XXXX	PSP429A
5.502	5.028	0.538	5.498			X	XXXX	PSP429AT
6.002	5.528	0.375	5.998	X			XXXX	PSP433A
6.002	5.528	0.538	5.998			X	XXXX	PSP433AT
6.502	6.028	0.375	6.498		X		XXXX	PSP437A
7.002	6.528	0.538	6.998			X	XXXX	PSP439AT
8.002	7.528	0.375	7.998		X		XXXX	PSP443A
12.002	11.528	0.375	11.998		X		XXXX	PSP452A

\*If used with wear rings, refer to wear ring piston diameter, see Section 9.

NOTE: For sizes larger than those shown in the table, please contact your local Parker Seal representative.



# Piston Seal CC Profile

Catalog EPS 5370/USA



## CC Profile, High Pressure Split Cap Piston Seal

Parker's CC profile, also known as the ChemCast™ seal, is a bi-directional piston seal designed for heavy duty applications. The CC profile design consists of a self-lubricated, glass reinforced, heat-stabilized, thermoplastic O.D. sealing ring that is energized by a flexible, oval shape, energizer. When installed in the bore, the precision step cut ring is aligned and compressed to provide drift free operation that can withstand pressure exceeding 50,000 psi. The hard thermoplastic cap allows the CC profile to work effectively in substandard, rough-surfaced cylinders with much lower tolerances. The CC is an excellent choice for mobile equipment experiencing shock loads. The CC profile can pass over ports, resist cold flow and protect against metal-to-metal contact.

The CC profile is sold only as an assembly (seal and energizer). See part number nomenclature.

### Technical Data

Standard Materials	Temperature Range	Pressure Range†	Surface Speed
<b>Cap</b> W4650NHH	-65°F to 300°F (-54°C to 149°C)	50,000 psi (3,447 bar)	< 3.3 ft/s (1.0 m/sec)
<b>Energizer</b> A 80A Nitrile	-40°F to 250°F (-40°C to 121°C)		

†Pressure Range without wear rings (see Table 2-4, page 2-5).

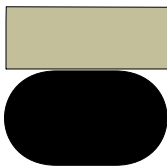

CC Cross-Section

### Part Number Nomenclature — CC Profile

Part numbers are provided in Table 7-8, page 7-12.



CC installed in Piston Gland

09/01/07

**Gland Dimensions — CC Profile — Inch**

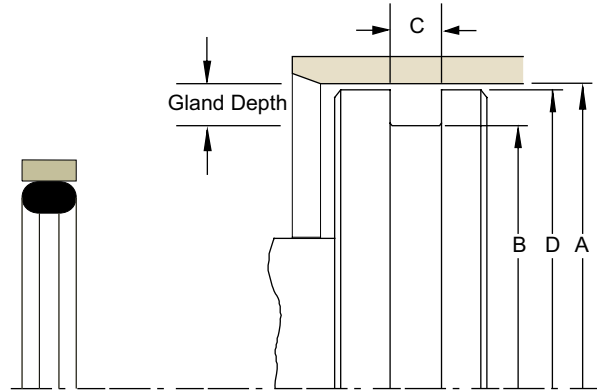

Please refer to Engineering Section 2, Page 2-8 for surface finish and additional hardware considerations.

**Table 7-8. CC Gland Dimensions — Inch**

A Bore Diameter	B Groove Diameter	C Groove Width	D Piston Diameter*	Custom Part Number
<b>+0.005/-0.000</b>	<b>+0.000/-0.005</b>	<b>+0.005/-0.000</b>	<b>+0.000/-0.005</b>	
1.500	1.042	0.252	1.448	<b>090150011</b>
1.750	1.292	0.252	1.698	<b>090175012</b>
2.000	1.462	0.282	1.935	<b>090200011</b>
2.000	1.462	0.312	1.935	<b>090200021</b>
2.250	1.712	0.282	2.185	<b>090225011</b>
2.500	1.962	0.282	2.435	<b>090250011</b>
2.500	1.962	0.312	2.435	<b>090250021</b>
2.750	2.212	0.282	2.685	<b>090275011</b>
3.000	2.442	0.282	2.920	<b>090300011</b>
3.000	2.442	0.312	2.920	<b>090300021</b>
3.025	2.467	0.282	2.945	<b>090302511</b>
3.250	2.692	0.282	3.170	<b>090325011</b>
3.500	2.942	0.282	3.420	<b>090350011</b>
3.500	2.942	0.312	3.420	<b>090350021</b>
4.000	3.442	0.312	3.920	<b>090400021</b>
4.000	3.442	0.282	3.920	<b>090400011</b>
4.000	3.442	0.424	3.920	<b>090400031</b>
4.250	3.692	0.282	4.170	<b>090425011</b>
4.500	3.942	0.375	4.420	<b>090450051</b>
4.500	3.942	0.312	4.420	<b>090450021</b>
4.525	3.967	0.282	4.445	<b>090452251</b>
5.000	4.442	0.282	4.920	<b>090500011</b>
5.000	4.442	0.375	4.920	<b>090500051</b>
5.025	4.467	0.282	4.945	<b>090502511</b>
5.025	4.467	0.375	4.945	<b>090502521</b>
6.000	5.240	0.375	5.900	<b>090600011</b>

A Bore Diameter	B Groove Diameter	C Groove Width	D Piston Diameter*	Custom Part Number
<b>+0.005/-0.000</b>	<b>+0.000/-0.005</b>	<b>+0.005/-0.000</b>	<b>+0.000/-0.005</b>	
6.025	5.265	0.375	5.925	<b>090602511</b>
6.500	5.740	0.375	6.400	<b>090650011</b>
7.000	6.240	0.375	6.900	<b>090700011</b>
7.015	6.255	0.375	6.915	<b>090701511</b>
7.500	6.740	0.375	7.400	<b>090750011</b>
8.000	7.240	0.375	7.900	<b>090800011</b>
8.025	7.265	0.375	7.925	<b>090802511</b>
8.500	7.740	0.375	8.400	<b>090850011</b>
8.500	7.740	0.375	8.400	<b>090850021</b>
9.000	8.124	0.375	8.890	<b>090900011</b>
9.025	8.149	0.375	8.915	<b>090902511</b>
9.500	8.624	0.375	9.390	<b>090950011</b>
10.000	9.124	0.375	9.890	<b>091000011</b>
10.023	9.147	0.375	9.913	<b>091002311</b>
12.000	11.124	0.375	11.890	<b>091200011</b>
12.500	11.624	0.375	12.390	<b>091250011</b>
13.000	12.124	0.375	12.890	<b>091300011**</b>
13.500	12.624	0.375	13.390	<b>091350011**</b>
14.000	13.124	0.375	13.870	<b>091400011**</b>
15.000	14.124	0.375	14.870	<b>091500011**</b>
15.500	14.624	0.375	15.370	<b>091550011**</b>
17.000	16.124	0.375	16.870	<b>091700011**</b>
18.000	17.124	0.375	17.870	<b>091800011**</b>
22.000	21.124	0.375	21.870	<b>092200011**</b>
26.000	25.124	0.375	25.870	<b>092600011**</b>
36.000	35.124	0.375	35.870	<b>093600011**</b>

\* If used with wear rings, refer to wear ring piston diameter, see Section 9.

\* If used with wear rings, refer to wear ring piston diameter, see Section 9.

\*\*Segmented ring.

NOTE: For sizes larger than those shown in the table, please contact your local Parker Seal representative.

# Piston Seal OK Profile

Catalog EPS 5370/USA



## OK Profile, High Pressure Split Cap Piston Seal

The OK profile is a bi-directional piston seal designed for heavy duty hydraulic applications. Its durable, two-piece design installs easily onto a solid piston without the necessity of auxiliary tools. When installed into the bore, the diameter of the OK profile is compressed to close the step cut in the cap to provide excellent, drift free sealing performance. The glass-filled nylon sealing surface handles the toughest applications. It will resist shock loads, wear, contamination, and will resist extrusion or chipping when passing over cylinder ports. The rectangular nitrile energizer ring ensures resistance to compression set to increase seal life.

The OK profile is sold only as an assembly. See part number nomenclature.

### Technical Data

Standard Materials	Temperature Range	Pressure Range†	Surface Speed
<b>Cap</b> W4650NHH	-65°F to 275°F (-54°C to 135°C)	7250 psi (500 bar)	< 3.3 ft/s (1.0 m/sec)
<b>Energizer</b> A 70A Nitrile	-40°F to 250°F (-40°C to 121°C)		

†Pressure Range without wear rings (see Table 2-4, page 2-5).



OK Cross-Section



OK installed in Piston Gland

7

09/01/07

**OK Profile**

**Part Number Nomenclature — OK Profile**

Table 7-9. OK Profile — Inch

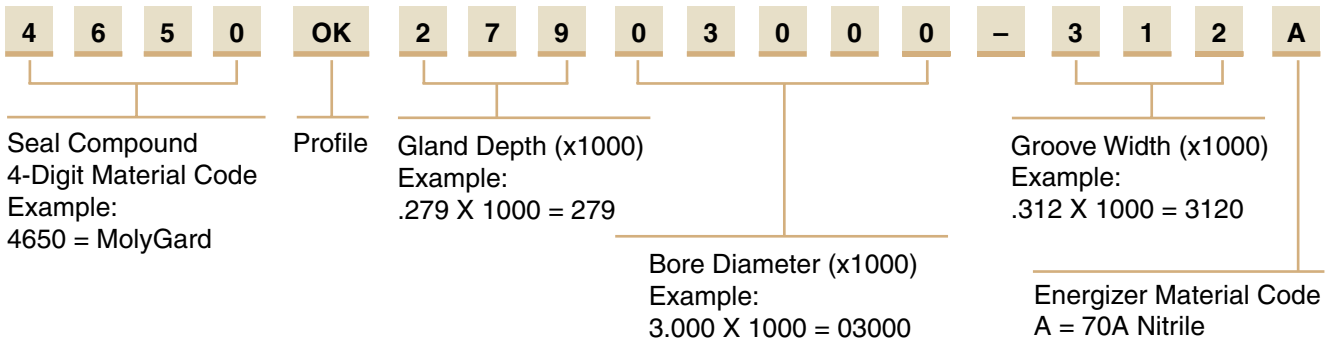

**Gland Dimensions — OK Profile**

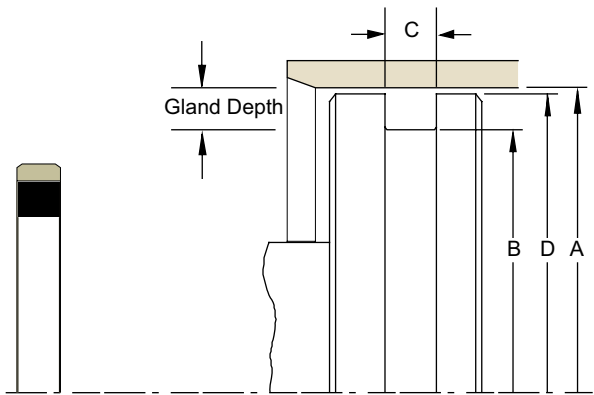

Please refer to Engineering Section 2, Page 2-8 for surface finish and additional hardware considerations.

Table 7-10. OK Gland Dimensions — Inch

A Bore Diameter +.005/-.000	B Groove Diameter +.000/-.005	C Groove Width +.005/-.000	D Piston Diameter* +.000/-.001	Part Number
1.500	0.962	0.282	1.435	4650OK26901500-282A
2.000	1.462	0.282	1.935	4650OK26902000-282A
2.500	1.962	0.282	2.435	4650OK26902500-282A
2.500	1.962	0.312	2.435	4650OK26902500-312A
2.750	2.192	0.282	2.670	4650OK27902750-282A
3.000	2.442	0.312	2.920	4650OK27903000-312A
3.250	2.692	0.312	3.170	4650OK27903250-312A
3.500	2.942	0.282	3.420	4650OK27903500-282A
3.500	2.942	0.312	3.420	4650OK27903500-312A
3.750	3.192	0.282	3.670	4650OK27903750-282A
4.000	3.442	0.282	3.920	4650OK27904000-282A
4.000	3.402	0.315	3.920	4650OK29904000-315A
4.500	3.942	0.282	4.420	4650OK27904500-282A
5.000	4.442	0.282	4.920	4650OK27905000-282A
5.500	4.740	0.377	5.400	4650OK38005500-377A
6.000	5.240	0.377	5.900	4650OK38006000-377A
7.000	6.240	0.377	6.900	4650OK38007000-377A
8.000	7.240	0.377	7.900	4650OK38008000-377A

\*If used with wear rings, refer to wear ring piston diameter, see Section 9.

NOTE: For sizes larger than those shown in the table, please contact your local Parker Seal representative.

# Piston Seal PIP Profile

Catalog EPS 5370/USA

## PIP Profile, Loaded Lip Seal with Pressure Inverting Pedestal



The Parker PIP profile combines a “Pressure Inverting Pedestal” with a Type B PolyPak to provide excellent, bi-directional piston sealing in hydraulic applications. The Pressure Inverting Pedestal conforms to the beveled sealing lips of the Type B PolyPak to provide extrusion resistance when pressure is applied to the heel side of the seal. The PIP profile requires only a single seal groove for installation. This eliminates the use of two PolyPaks on the piston to save space and increase bearing length.

**Note:** The PIP profile may be purchased as an assembly (Type B PolyPak and PIP ring) or separately as a PIP ring only. If purchasing as an assembly, the standard material is a 4615 Type B PolyPak with 4617 PIP ring. If you desire alternate material combinations, please order the PIP ring and Type B PolyPak separately. Call your Parker Seal representative for details.

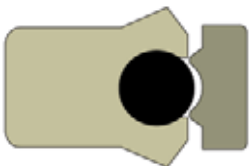

PIP Cross-Section

### Technical Data

Standard Materials*	Temperature Range	Pressure Range†	Surface Speed
<b>Type B Polypak</b>			
P4615A90	-65°F to 200°F (-54°C to 93°C)	5,000 psi (344 bar)	< 1.6 ft/s (0.5 m/s)
<b>PIP Ring</b>			
P4617D65	-65°F to 250°F (-54°C to 121°C)	5,000 psi (344 bar)	< 1.6 ft/s (0.5 m/s)
<b>Optional Materials</b>			
<b>PIP Ring</b>			
Z4652D65	-65°F to 275°F (-54°C to 135°C)	10,000 psi** (689 bar)	
W4685R119	-65°F to 500°F (-54°C to 260°C)	10,000+ psi (689 bar)	

**\*Alternate Materials:** For applications that may require an alternate material, please contact your local Parker Seal representative.

**†Pressure Range** without wear rings (see Table 2-4, page 2-5).

**\*\*Pressure rating** dependant on entire assembly of PolyPak shell/energizer and PIP ring.

**Note:** The PIP may be ordered separately. Please contact your local Parker Seal representative.



PIP installed in Piston Gland



**PIP Profile**

**Part Number Nomenclature — PIP Assembly Profile**

**Table 7-11. PIP Assembly Profile — Inch**

<b>4</b>	<b>6</b>	<b>1</b>	<b>5</b>	<b>2</b>	<b>5</b>	<b>0</b>	<b>0</b>	<b>2</b>	<b>5</b>	<b>0</b>	<b>0</b>	<b>P</b>	<b>3</b>	<b>7</b>	<b>5</b>	<b>B</b>
Seal Compound 4-Digit Material Code Example: 4615 = 90A Molythane				Gland Depth (x1000) or Seal Nominal Radial Cross-Section Example: .250 x 1000 = 250			Seal Nominal I.D. (x1000) Example: 2.500 x 1000 = 02500					Cap Profile PIP 4617 is standard for assemblies only		Base Profile Type B PolyPak Axial Width		

**Part Number Nomenclature — PIP Ring Only Profile**

**Table 7-12. PIP Ring Only Profile — Inch**

<b>4</b>	<b>6</b>	<b>1</b>	<b>7</b>	<b>2</b>	<b>5</b>	<b>0</b>	<b>0</b>	<b>2</b>	<b>5</b>	<b>0</b>	<b>0</b>	<b>PR</b>
PIP Ring Compound 4-Digit Material Code Example: 4617 = 90A Molythane 4652 = PolyMyte 4685 = UltraCOMP				Gland Depth (x1000) or Seal Nominal Radial Cross-Section Example: .250 x 1000 = 250			Seal Nominal I.D. (x1000) Example: 2.500 x 1000 = 02500					Profile

**Gland Dimensions — PIP Profile**

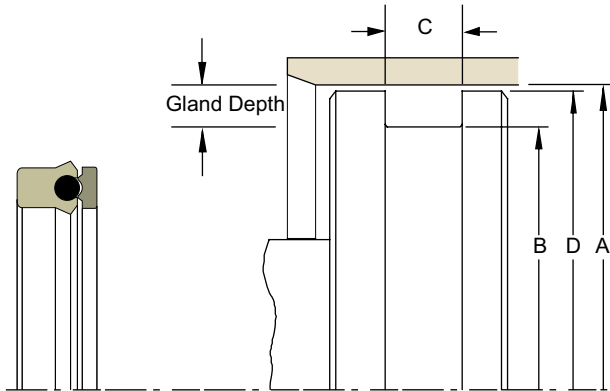

Please refer to Engineering Section 2, Page 2-8 for surface finish and additional hardware considerations.

**Table 7-13. Gland Dimension Tolerances**

Nominal Gland Depth	A Bore Diameter	B Groove Diameter	C Groove Width	D Piston Diameter
1/8	+0.002/-0.000	+0.000/-0.002	+0.015/-0.000	+0.000/-0.001
3/16	+0.002/-0.000	+0.000/-0.002		+0.000/-0.002
1/4	+0.003/-0.000	+0.000/-0.003		+0.000/-0.002
5/16	+0.003/-0.000	+0.000/-0.004		+0.000/-0.002
3/8	+0.004/-0.000	+0.000/-0.005		+0.000/-0.002
7/16	+0.005/-0.000	+0.000/-0.006		+0.000/-0.002
1/2	+0.005/-0.000	+0.000/-0.007		+0.000/-0.003
9/16	+0.006/-0.000	+0.000/-0.008		+0.000/-0.003
5/8	+0.006/-0.000	+0.000/-0.009		+0.000/-0.003
3/4	+0.007/-0.000	+0.000/-0.010		+0.000/-0.004
7/8	+0.008/-0.000	+0.000/-0.011		+0.000/-0.005
1	+0.009/-0.000	+0.000/-0.012		+0.000/-0.005

**Table 7-14. PIP Gland Dimensions — Inch**

A Bore Diameter	B Groove Diameter	C Groove Width	D Piston Diameter*	Part Number
1.250	0.875	0.453	1.249	<b>461518700875P312B</b>
1.250	1.000	0.340	1.249	<b>461512501000P250B</b>
1.500	1.000	0.550	1.499	<b>461525001000P375B</b>
1.500	1.125	0.453	1.498	<b>461518701125P312B</b>
1.500	1.250	0.340	1.499	<b>461512501250P250B</b>
1.562	1.312	0.271	1.561	<b>461512501312P187B</b>

\*If used with wear rings, refer to wear ring piston diameter, see Section 9.

A Bore Diameter	B Groove Diameter	C Groove Width	D Piston Diameter*	Part Number
1.625	1.375	0.340	1.624	<b>461512501375P250B</b>
1.687	1.437	0.340	1.686	<b>461512501437P250B</b>
1.750	1.250	0.550	1.749	<b>461525001250P375B</b>
1.750	1.375	0.453	1.749	<b>461518701375P312B</b>
1.750	1.500	0.340	1.749	<b>461512501500P250B</b>
2.000	1.500	0.550	1.999	<b>461525001500P375B</b>

\*If used with wear rings, refer to wear ring piston diameter, see Section 9.

09/01/07





Table 7-14. PIP Gland Dimensions — Inch (Continued)

A Bore Diameter	B Groove Diameter	C Groove Width	D Piston Diameter*	Part Number	A Bore Diameter	B Groove Diameter	C Groove Width	D Piston Diameter*	Part Number
2.000	1.625	0.453	1.999	461518701625P312B	5.000	4.500	0.550	4.999	461525004500P375B
2.000	1.625	0.523	1.999	461518701625P375B	5.000	4.500	0.688	4.999	461525004500P500B
2.125	1.750	0.523	2.124	461518701750P375B	5.000	4.500	0.756	4.999	461525004500P562B
2.250	1.750	0.550	2.249	461525001750P375B	5.125	4.500	0.853	5.123	461531204500P625B
2.250	1.875	0.523	2.249	461518701875P375B	5.125	4.625	0.756	5.124	461525004625P562B
2.250	2.000	0.271	2.249	461512502000P187B	5.250	4.750	0.756	5.249	461525004750P562B
2.375	2.000	0.523	2.374	461518702000P375B	5.375	4.875	0.756	5.374	461525004875P562B
2.500	1.875	0.715	2.499	461531201875P500B	5.500	4.750	0.895	5.498	461537504750P625B
2.500	2.000	0.550	2.499	461525002000P375B	5.500	5.000	0.550	5.499	461525005000P375B
2.500	2.125	0.523	2.499	461518702125P375B	5.500	5.000	0.756	5.499	461525005000P562B
2.625	2.250	0.523	2.624	461518702250P375B	5.750	5.000	0.895	5.748	461537505000P625B
2.750	2.250	0.550	2.749	461525002250P375B	5.750	5.250	0.550	5.749	461525005250P375B
2.750	2.375	0.403	2.749	461518702375P266B	5.750	5.250	0.756	5.749	461525005250P562B
2.750	2.375	0.523	2.749	461518702375P375B	6.000	5.000	1.100	5.998	461550005000P750B
2.875	2.250	0.715	2.873	461531202250P500B	6.000	5.250	0.758	5.998	461537505250P500B
2.875	2.500	0.523	2.874	461518702500P375B	6.000	5.250	0.895	5.998	461537505250P625B
3.000	2.250	0.895	2.998	461537502250P625B	6.000	5.500	0.550	5.999	461525005500P375B
3.000	2.375	0.715	2.998	461531202375P500B	6.000	5.500	0.756	5.999	461525005500P562B
3.000	2.500	0.413	2.999	461525002500P250B	6.125	5.500	0.853	6.123	461531205500P625B
3.000	2.500	0.550	2.999	461525002500P375B	6.250	5.250	0.825	6.248	461550005250P500B
3.000	2.625	0.523	2.999	461518702625P375B	6.250	5.250	1.100	6.248	461550005250P750B
3.125	2.750	0.523	3.124	461518702750P375B	6.250	5.500	0.895	6.248	461537505500P625B
3.250	2.500	0.895	3.248	461537502500P625B	6.375	5.625	0.895	6.373	461537505625P625B
3.250	2.625	0.715	3.248	461531202625P500B	6.500	5.750	0.895	6.498	461537505750P625B
3.250	2.750	0.550	3.249	461525002750P375B	6.500	6.000	0.550	6.499	461525006000P375B
3.250	2.875	0.523	3.249	461518702875P375B	6.500	6.000	0.618	6.499	461525006000P437B
3.375	2.875	0.550	3.374	461525002875P375B	6.500	6.000	0.756	6.499	461525006000P562B
3.375	3.000	0.523	3.374	461518703000P375B	6.750	6.250	0.756	6.749	461525006250P562B
3.500	3.000	0.550	3.499	461525003000P375B	7.000	6.250	0.895	6.998	461537506250P625B
3.500	3.125	0.523	3.499	461518703125P375B	7.000	6.500	0.550	6.999	461525006500P375B
3.625	3.125	0.550	3.624	461525003125P375B	7.000	6.500	0.756	6.999	461525006500P562B
3.750	3.250	0.550	3.749	461525003250P375B	7.250	6.500	0.895	7.248	461537506500P625B
3.875	3.375	0.550	3.874	461525003375P375B	7.250	6.750	0.756	7.249	461525006750P562B
4.000	3.250	0.895	3.998	461537503250P625B	7.500	6.750	0.895	7.498	461537506750P625B
4.000	3.375	0.715	3.998	461531203375P500B	7.500	7.000	0.756	7.499	461525007000P562B
4.000	3.500	0.550	3.999	461525003500P375B	8.000	7.000	1.100	7.998	461550007000P750B
4.000	3.625	0.523	3.999	461518703625P375B	8.000	7.250	0.895	7.998	461537507250P625B
4.250	3.750	0.550	4.249	461525003750P375B	8.000	7.500	0.756	7.999	461525007500P562B
4.250	3.875	0.523	4.249	461518703875P375B	8.250	7.750	0.756	8.249	461525007750P562B
4.375	4.000	0.523	4.374	461518704000P375B	8.500	7.750	0.895	8.498	461537507750P625B
4.500	3.750	0.895	4.498	461537503750P625B	9.000	8.000	1.100	8.998	461550008000P750B
4.500	4.000	0.550	4.499	461525004000P375B	9.250	8.500	0.895	9.248	461537508500P625B
4.500	4.000	0.756	4.499	461525004000P562B	9.875	9.250	0.853	9.873	461531209250P625B
4.750	4.000	0.895	4.748	461537504000P625B	10.000	9.000	1.100	9.998	461550009000P750B
4.750	4.250	0.550	4.749	461525004250P375B	10.375	9.750	0.853	10.373	461531209750P625B
4.750	4.250	0.756	4.749	461525004250P562B	10.500	9.500	1.100	10.498	461550009500P750B
4.875	4.250	0.783	4.873	461531204250P562B	11.000	10.000	1.100	10.998	461550010000P750B
5.000	4.000	1.100	4.998	461550004000P750B	11.500	10.500	1.100	11.498	461550010500P750B
5.000	4.250	0.895	4.998	461537504250P625B	12.000	11.000	1.100	11.998	461550011000P750B
5.000	4.375	0.783	4.998	461531204375P562B	12.250	11.250	1.100	12.248	461550011250P750B

\*If used with wear rings, refer to wear ring piston diameter, see Section 9.

\*If used with wear rings, refer to wear ring piston diameter, see Section 9.

7

## PIP Profile

Table 7-14. PIP Gland Dimensions — Inch (Continued)

A Bore Diameter	B Groove Diameter	C Groove Width	D Piston Diameter*	Part Number	A Bore Diameter	B Groove Diameter	C Groove Width	D Piston Diameter*	Part Number
12.500	11.500	1.100	12.498	<b>461550011500P750B</b>	16.000	14.500	1.788	15.997	<b>461575014500P1250B</b>
12.875	11.875	1.100	12.873	<b>461550011875P750B</b>	16.000	15.000	1.100	15.998	<b>461550015000P750B</b>
13.000	12.000	1.100	12.998	<b>461550012000P750B</b>	20.000	19.000	1.100	19.998	<b>461550019000P750B</b>
13.000	12.250	0.895	12.998	<b>461537512250P625B</b>	21.250	20.250	1.100	21.248	<b>461550020250P750B</b>
14.000	13.500	0.756	13.998	<b>461525013500P562B</b>	22.000	21.000	1.100	21.998	<b>461550021000P750B</b>
15.000	14.000	1.100	14.998	<b>461550014000P750B</b>	25.500	24.500	1.100	25.498	<b>461550024500P750B</b>
15.000	14.250	0.895	14.998	<b>461537514250P625B</b>	39.250	38.250	1.100	39.248	<b>461550038250P750B</b>
15.750	14.750	1.100	15.748	<b>461550014750P750B</b>	43.000	42.000	1.100	42.998	<b>461550042000P750B</b>

\*If used with wear rings, refer to wear ring piston diameter, see Section 9.

\*If used with wear rings, refer to wear ring piston diameter, see Section 9.

NOTE: For sizes larger than those shown in the table, please contact your local Parker Seal representative.

# Piston Seal B7 Profile

Catalog EPS 5370/USA



**B7 Cross-Section**

## B7 Profile, U-cup Piston Seal

The B7 profile is a non-symmetrical, hydraulic cylinder piston seal. The knife trimmed, beveled lip contacts the bore to provide enhanced low to high pressure sealing and wiping action. When installed, the diameter of the B7 profile is stretched slightly to fit the gland. This ensures a tight static seal with the gland and improves stability in application. The B7 profile is available in Parker proprietary urethane compounds providing excellent wear, extrusion and compression set resistance. The B7 profile is a uni-directional seal. Two seals can be placed on a piston, back to back, in separate glands offering bi-directional fluid sealing.

### Technical Data

Standard Materials*	Temperature Range	Pressure Range†	Surface Speed
P4300A90	-65°F to 275°F (-54°C to 135°C)	5,000 psi (344 bar)	< 1.6 ft/s (0.5 m/s)
P4301A90	-65°F to 275°F (-54°C to 135°C)	5000 psi (344 bar)	< 1.6 ft/s (0.5 m/s)
P4700A90	-65°F to 200°F (-54°C to 93°C)	5,000 psi (344 bar)	< 1.6 ft/s (0.5 m/s)
P5065A88	-70°F to 200°F (-57°C to 93°C)	3,500 psi (241 bar)	< 1.6 ft/s (0.5 m/s)

\***Alternate Materials:** For applications that may require an alternate material, please contact your local Parker Seal representative.

†**Pressure Range** without wear rings (see Table 2-4, page 2-5).



**B7 installed in Piston Gland**



09/01/07

**B7 Profile**

**Part Number Nomenclature — B7 Profile**

Table 7-15. B7 Profile — Inch

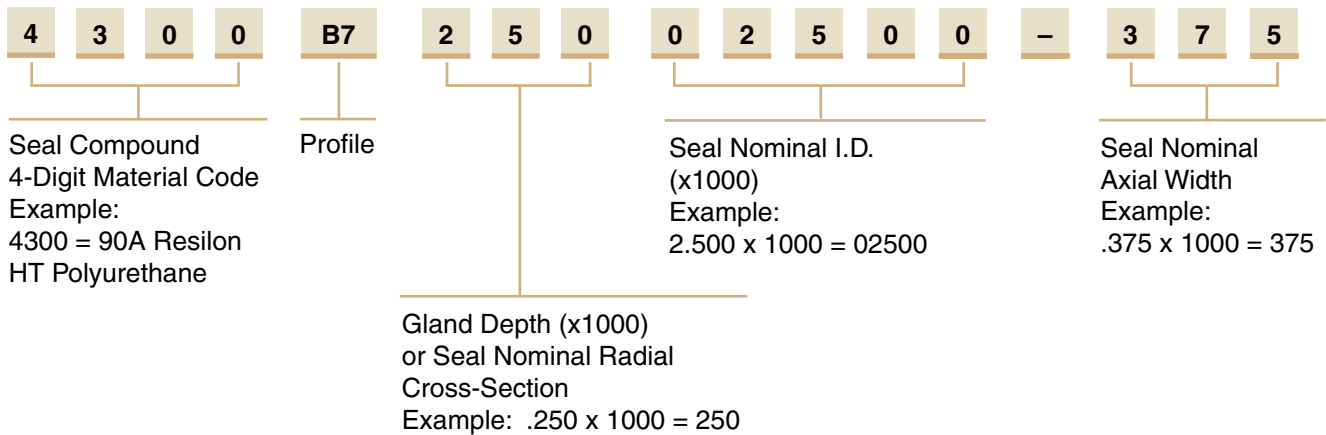

**Gland Dimensions — B7 Profile**

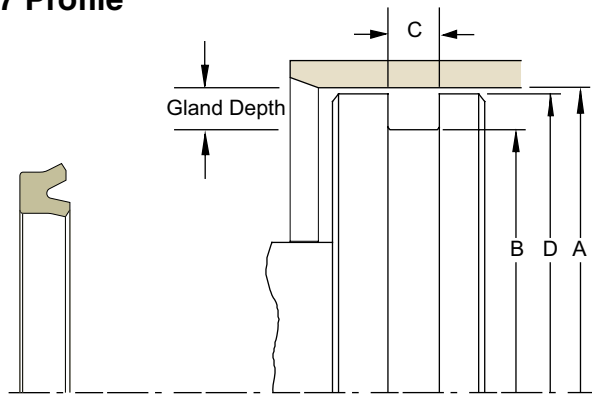

Table 7-16. Gland Dimension Tolerances

Nominal Gland Depth	A Bore Diameter	B Groove Diameter	C Groove Width	D Piston Diameter
1/8	+.002/- .000	+.000/- .002	+.015/- .000	+.000/- .001
3/16	+.002/- .000	+.000/- .002		+.000/- .002
1/4	+.003/- .000	+.000/- .003		+.000/- .002
5/16	+.003/- .000	+.000/- .004		+.000/- .002
3/8	+.004/- .000	+.000/- .005		+.000/- .002

Please refer to Engineering Section 2, Page 2-8 for surface finish and additional hardware considerations.

Table 7-17. B7 Gland Dimensions — Inch

A Bore Diameter	B Groove Diameter	C Groove Width	D Piston Diameter*	Compound Code (X = Standard Offering)			Part Number		
				4300	4700	5065	Compound Code	Profile Code	
1.125	0.750	0.206	1.124	X		X	XXXX	B7	18700750-187
1.375	0.875	0.275	1.374	X		X	XXXX	B7	25000875-250
1.500	1.250	0.206	1.499	X		X	XXXX	B7	12501250-187
1.625	1.125	0.343	1.624		X	X	XXXX	B7	25001125-312
1.625	1.250	0.343	1.624	X		X	XXXX	B7	18701250-312
1.750	1.375	0.206	1.749	X		X	XXXX	B7	18701375-187
1.875	1.500	0.413	1.874	X		X	XXXX	B7	18701500-375
2.000	1.625	0.343	1.999	X		X	XXXX	B7	18701625-312

\*If used with wear rings, refer to wear ring piston diameter, see Section 9.

**Table 7-17. B7 Gland Dimensions — Inch (Continued)**

A Bore Diameter	B Groove Diameter	C Groove Width	D Piston Diameter*	Compound Code (X = Standard Offering)			Part Number		
				4300	4700	5065	Compound Code	Profile Code	
2.250	2.000	0.275	2.249	X		X	XXXX	B7	12502000-250
2.375	2.000	0.343	2.374	X		X	XXXX	B7	18702000-312
2.500	2.000	0.413	2.499	X		X	XXXX	B7	25002000-375
2.625	2.000	0.275	2.624	X		X	XXXX	B7	25002125-250
2.750	2.250	0.413	2.749	X		X	XXXX	B7	25002250-375
3.000	2.250	0.413	2.998		X	X	XXXX	B7	37502250-375
3.000	2.625	0.343	2.999	X		X	XXXX	B7	18702625-312
3.125	2.625	0.275	3.124	X		X	XXXX	B7	25002625-250
3.250	2.500	0.481	3.248		X	X	XXXX	B7	37502500-437
3.250	2.750	0.413	3.249	X		X	XXXX	B7	25002750-375
4.000	3.250	0.413	3.998		X	X	XXXX	B7	37503250-375
4.000	3.500	0.413	3.999	X		X	XXXX	B7	25003500-375
4.500	3.750	0.550	4.498		X	X	XXXX	B7	37503750-500
6.000	4.250	0.550	5.998		X	X	XXXX	B7	37505250-500

\*If used with wear rings, refer to wear ring piston diameter, see Section 9.

NOTE: For sizes larger than those shown in the table, please contact your local Parker Seal representative.

**Part Number Nomenclature — B7 Profile**

**Table 7-18. B7 Profile — Metric**

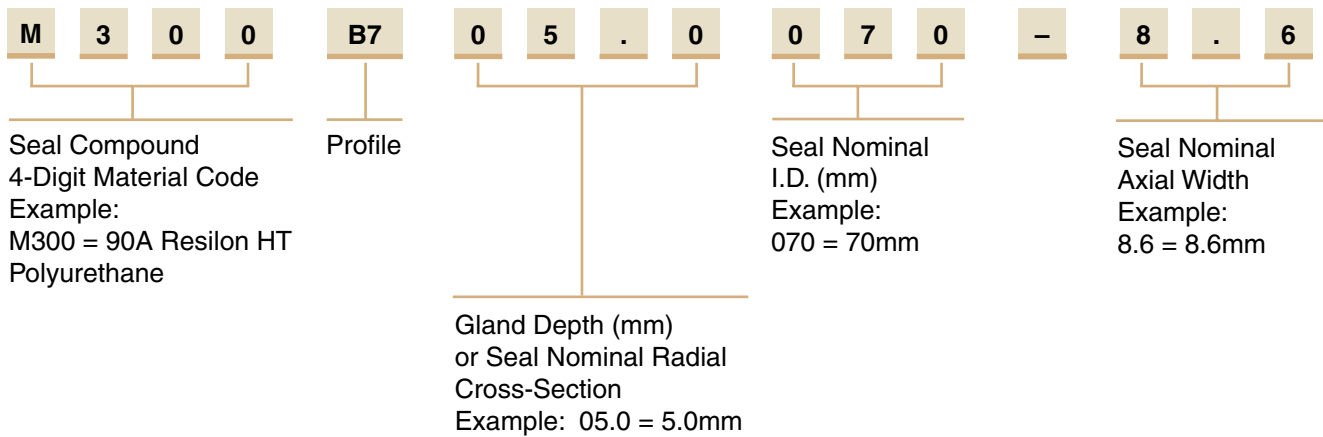

**B7 Profile**

**Gland Dimensions — B7 Profiles**

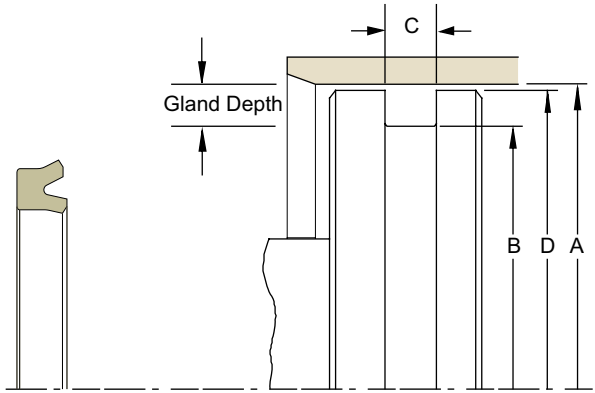

Please refer to Engineering Section 2, Page 2-8 for surface finish and additional hardware considerations.

**Table 7-19. B7 Gland Dimensions — Metric (mm)**

A Bore Diameter	B Groove Diameter	C Groove Width	D Piston Diameter*	Compound Code (X = Standard Offering)			Part Number		
				M300	M700	M065	Compound Code	Profile Code	
H9	h9	+ .25/- .00	f8						
For ISO tolerances refer to Appendix F.									
40	30	8	40	X		X	XXXX	B7	05.0030-7.3
43	35	10	43	X		X	XXXX	B7	04.0035-9
45	34	8	45		X	X	XXXX	B7	05.5034-7.3
45	35	8	45	X		X	XXXX	B7	05.0035-7.3
50	40	8	50	X		X	XXXX	B7	05.0040-7.3
55	45	8	55	X		X	XXXX	B7	05.0045-7.3
60	50	7	60	X		X	XXXX	B7	05.0050-6
60	50	8	60	X		X	XXXX	B7	05.0050-7.3
60	50	8	60		X	X	XXXX	B7	05.0050-7.3
65	55	7.6	65	X		X	XXXX	B7	05.0055-7
70	60	8	70	X		X	XXXX	B7	05.0060-7.3
75	63	8	75	X		X	XXXX	B7	06.0063-7.3
80	65	12.5	80	X		X	XXXX	B7	07.5065-11.4
80	70	7.6	80	X		X	XXXX	B7	05.0070-7.0
80	70	9.5	80	X		X	XXXX	B7	05.0070-8.6
120	100	16	120	X		X	XXXX	B7	10.0100-14.5

\*If used with wear rings, refer to wear ring piston diameter, see Section 9.

NOTE: For sizes larger than those shown in the table, please contact your local Parker Seal representative.



# Piston Seal UP Profile

Catalog EPS 5370/USA

## UP Profile, Industrial U-cup Piston Seal

The UP profile is a non-symmetrical, hydraulic piston seal. The knife trimmed, beveled lip faces the bore to provide enhanced low to high pressure sealing and wiping action. The UP profile is a uni-directional seal. Two UP seals can be used, back to back, in separate grooves to provide bi-directional pressure sealing. The UP profile is an economical choice, available in Parker's wear and extrusion resistant Molythane compound.



### Technical Data

Standard Materials*	Temperature Range	Pressure Range†	Surface Speed
P4615A90	-65°F to 200°F (-54°C to 93°C)	5,000 psi (344 bar)	< 1.6 ft/s (0.5 m/s)

\***Alternate Materials:** For applications that may require an alternate material, please contact your local Parker Seal representative.

†**Pressure Range** without wear rings (see Table 2-4, page 2-5).



*UP Cross-Section*



*UP installed in Piston Gland*

7

09/01/07

**UP Profile**

**Part Number Nomenclature — UP Profile**

**Table 7-20. UP Profile — Inch**

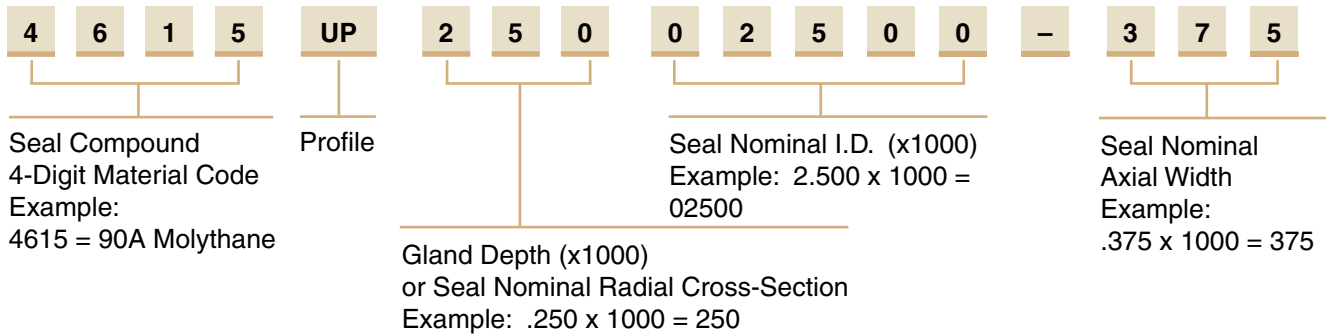

**Gland Dimensions — UP Profile**

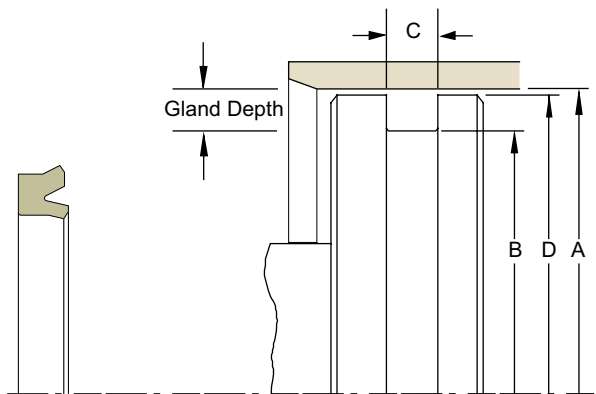

**Table 7-21. Gland Dimension Tolerances**

Nominal Gland Depth	A Bore Diameter	B Groove Diameter	C Groove Width	D Piston Diameter
1/8	+0.002/-0.000	+0.000/-0.002	+0.015/-0.000	+0.000/-0.001
3/16	+0.002/-0.000	+0.000/-0.002		+0.000/-0.002
1/4	+0.003/-0.000	+0.000/-0.003		+0.000/-0.002
5/16	+0.003/-0.000	+0.000/-0.004		+0.000/-0.002
3/8	+0.004/-0.000	+0.000/-0.005		+0.000/-0.002

7

Please refer to Engineering Section 2, Page 2-8 for surface finish and additional hardware considerations.

**Table 7-22. UP Gland Dimensions — Inch**

A Bore Diameter	B Groove Diameter	C Groove Width	D Piston Diameter*	Part Number
0.750	0.500	0.206	0.749	<b>4615UP12500500-187</b>
0.750	0.500	0.275	0.749	<b>4615UP12500500-250</b>
1.250	1.000	0.206	1.249	<b>4615UP12501000-187</b>
1.500	1.000	0.413	1.499	<b>4615UP25001000-375</b>
1.625	1.250	0.343	1.624	<b>4615UP18701250-312</b>
1.750	1.250	0.413	1.749	<b>4615UP25001250-375</b>
2.000	1.500	0.413	1.999	<b>4615UP25001500-375</b>
2.000	1.625	0.343	1.999	<b>4615UP18701625-312</b>
2.000	1.625	0.413	1.999	<b>4615UP18701625-375</b>
2.500	1.875	0.550	2.498	<b>4615UP31201875-500</b>
2.500	2.000	0.413	2.499	<b>4615UP25002000-375</b>
2.500	2.125	0.343	2.499	<b>4615UP18702125-312</b>
2.500	2.125	0.413	2.499	<b>4615UP18702125-375</b>
2.625	2.125	0.413	2.624	<b>4615UP25002125-375</b>
2.750	2.250	0.413	2.749	<b>4615UP25002250-375</b>
3.000	2.375	0.550	2.998	<b>4615UP31202375-500</b>

\*If used with wear rings, refer to wear ring piston diameter, see Section 9.

Table 7-22. UP Gland Dimensions — Inch (Continued)

A Bore Diameter	B Groove Diameter	C Groove Width	D Piston Diameter*	Part Number
3.000	2.500	0.413	2.999	4615UP25002500-375
3.250	2.750	0.413	3.249	4615UP25002750-375
3.250	2.875	0.413	3.249	4615UP18702875-375
3.500	2.875	0.550	3.498	4615UP31202875-500
3.500	3.000	0.413	3.499	4615UP25003000-375
3.750	3.000	0.688	3.748	4615UP37503000-625
3.750	3.125	0.550	3.748	4615UP31203125-500
3.750	3.250	0.413	3.749	4615UP25003250-375
4.000	3.250	0.688	3.998	4615UP37503250-625
4.000	3.375	0.550	3.998	4615UP31203375-500
4.000	3.500	0.413	3.999	4615UP25003500-375
4.000	3.625	0.413	3.999	4615UP18703625-375
4.250	3.750	0.413	4.249	4615UP25003750-375
4.500	3.750	0.688	4.498	4615UP37503750-625
4.500	4.000	0.413	4.499	4615UP25004000-375
5.000	4.250	0.688	4.998	4615UP37504250-625
5.000	4.375	0.618	4.998	4615UP31204375-562
5.000	4.500	0.413	4.999	4615UP25004500-375
5.000	4.500	0.618	4.999	4615UP25004500-562
5.500	5.000	0.413	5.499	4615UP25005000-375
5.500	5.000	0.618	5.499	4615UP25005000-562
6.000	5.250	0.688	5.998	4615UP37505250-625
6.000	5.500	0.413	5.999	4615UP25005500-375
6.500	5.750	0.688	6.498	4615UP37505750-625
7.000	6.250	0.688	6.998	4615UP37506250-625
7.500	6.750	0.688	7.498	4615UP37506750-625
9.000	8.250	0.688	8.998	4615UP37508250-625

\*If used with wear rings, refer to wear ring piston diameter, see Section 9.

NOTE: For sizes larger than those shown in the table, please contact your local Parker Seal representative.

# Piston Seal E4 Profile

Catalog EPS 5370/USA



## E4 Profile, Premium Rounded Lip U-cup Piston Seal

Parker's E4 profile is a non-symmetrical piston seal designed to seal both lubricated and non-lubricated air. To ensure that critical surfaces retain lubrication, the radius edge of the lip is designed to hydroplane over pre-lubricated surfaces. The standard compound for the E4 profile is Parker proprietary Nitroxile ELF compound N4274A85. This compound is formulated with proprietary internal lubricants to provide "Extreme Low Friction" and excellent wear resistance. This compound provides extended cycle life over standard nitrile and carboxylated nitrile compounds.

### Technical Data

Standard Materials*	Temperature Range	Pressure Range†	Surface Speed
N4274A85	-10°F to 250°F (-23°C to 121°C)	250 psi (17 bar)	< 3 ft/s (1 m/s)
N4180A80	-40°F to 250°F (-40°C to 121°C)	250 psi (17 bar)	< 3 ft/s (1 m/s)
V4208A90	-5°F to 400°F (-21°C to 204°C)	250 psi (17 bar)	< 3 ft/s (1 m/s)
P5065A88	-70°F to 200°F (-57°C to 93°C)	250 psi (17 bar)	< 3 ft/s (1 m/s)

\***Alternate Materials:** For applications that may require an alternate material, please contact your local Parker Seal representative.

†**Pressure Range** without wear rings (see Table 2-4, page 2-5).



E4 Cross-Section



E4 installed in Piston Gland

09/01/07

### Part Number Nomenclature — E4 Profile

Table 7-23. E4 Profile — Inch

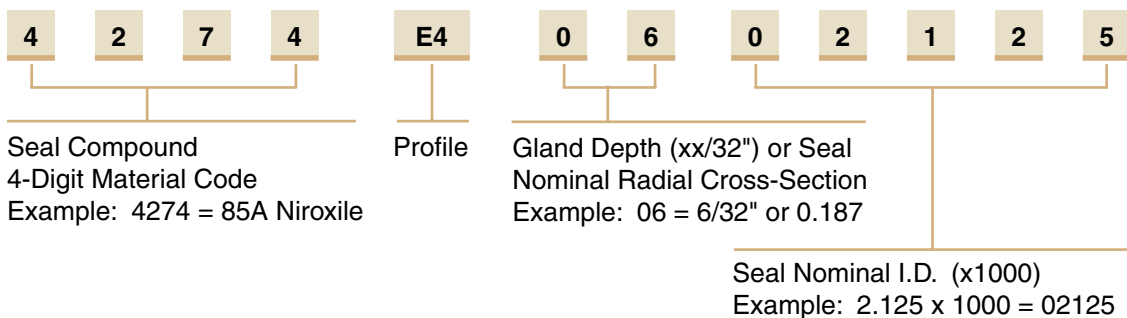

### Gland Dimensions — E4 Profile

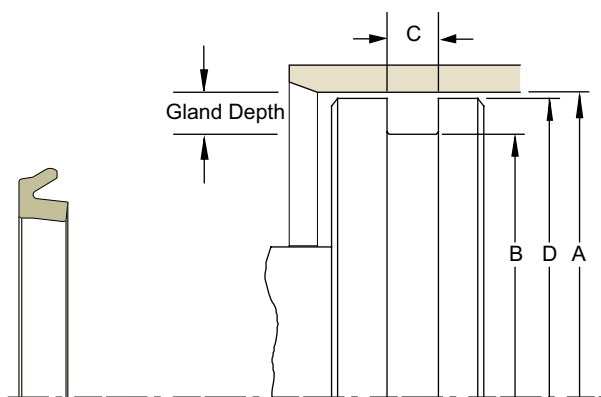

Please refer to Engineering Section 2, Page 2-8 for surface finish and additional hardware considerations.

Table 7-24. Gland Dimension Tolerances

Nominal Gland Depth	A Bore Diameter	B Groove Diameter	C Groove Width	D Piston Diameter
1/8	+0.002/-0.000	+0.000/-0.002	+0.015/-0.000	+0.000/-0.001
3/16	+0.002/-0.000	+0.000/-0.002		+0.000/-0.002
1/4	+0.003/-0.000	+0.000/-0.003		+0.000/-0.002
5/16	+0.003/-0.000	+0.000/-0.004		+0.000/-0.002
3/8	+0.004/-0.000	+0.000/-0.005		+0.000/-0.002
7/16	+0.005/-0.000	+0.000/-0.006		+0.000/-0.002
1/2	+0.005/-0.000	+0.000/-0.007		+0.000/-0.003
9/16	+0.006/-0.000	+0.000/-0.008		+0.000/-0.003
5/8	+0.006/-0.000	+0.000/-0.009		+0.000/-0.003
3/4	+0.007/-0.000	+0.000/-0.010		+0.000/-0.004
7/8	+0.008/-0.000	+0.000/-0.011		+0.000/-0.005
1	+0.009/-0.000	+0.000/-0.012		+0.000/-0.005

Table 7-25. E4 Gland Dimensions — Inch

A Bore Diameter	B Groove Diameter	C Groove Width	D Piston Diameter*	Compound Code				Part Number	
				4180	4274	4208	5065	Compound Code	
0.625	0.375	0.156	0.623	X	X		X	XXXX	E40400375
0.750	0.500	0.156	0.748	X	X			XXXX	E40400500
0.875	0.625	0.156	0.873	X	X			XXXX	E40400625
1.000	0.750	0.156	0.998	X	X		X	XXXX	E40400750
1.062	0.812	0.156	1.060	X				XXXX	E40400812
1.125	0.875	0.156	1.123	X	X			XXXX	E40400875
1.500	1.250	0.156	1.498		X			XXXX	E40401250
1.500	1.187	0.188	1.498	X	X	X	X	XXXX	E40501187
1.500	1.000	0.281	1.497		X			XXXX	E40801000
1.625	1.312	0.188	1.623		X			XXXX	E40501312
1.750	1.375	0.219	1.748	X	X			XXXX	E40601375
1.813	1.500	0.188	1.811	X				XXXX	E40501500
2.000	1.625	0.219	1.998	X	X	X	X	XXXX	E40601625
2.125	1.750	0.219	2.123		X			XXXX	E40601750
2.500	2.125	0.219	2.498	X	X	X	X	XXXX	E40602125
3.000	2.562	0.250	2.998	X	X	X	X	XXXX	E40702562
3.250	2.812	0.250	3.248	X	X	X		XXXX	E40702812
4.000	3.500	0.281	3.997	X	X		X	XXXX	E40803500

\*If used with wear rings, refer to wear ring piston diameter, see Section 9.

**E4 Profile**

**Table 7-25. E4 Gland Dimensions — Inch (Continued)**

A Bore Diameter	B Groove Diameter	C Groove Width	D Piston Diameter*	Compound Code				Part Number	
				4180	4274	4208	5065	Compound Code	
5.000	4.500	0.281	4.997	X		X		XXXX	E40804500
5.000	4.437	0.312	4.997		X			XXXX	E40904437
6.000	5.500	0.281	5.997		X			XXXX	E40805500
6.000	5.437	0.312	5.997		X			XXXX	E40905437
6.000	5.375	0.344	5.997		X			XXXX	E41005375
8.000	7.375	0.344	7.997		X			XXXX	E41007375
8.000	7.250	0.406	7.997		X			XXXX	E41207250
10.000	9.312	0.375	9.997		X			XXXX	E41109312

\*If used with wear rings, refer to wear ring piston diameter, see Section 9.

NOTE: For sizes larger than those shown in the table, please contact your local Parker Seal representative.

**Part Number Nomenclature — E4 Profile**

**Table 7-26. E4 Profile — Metric**

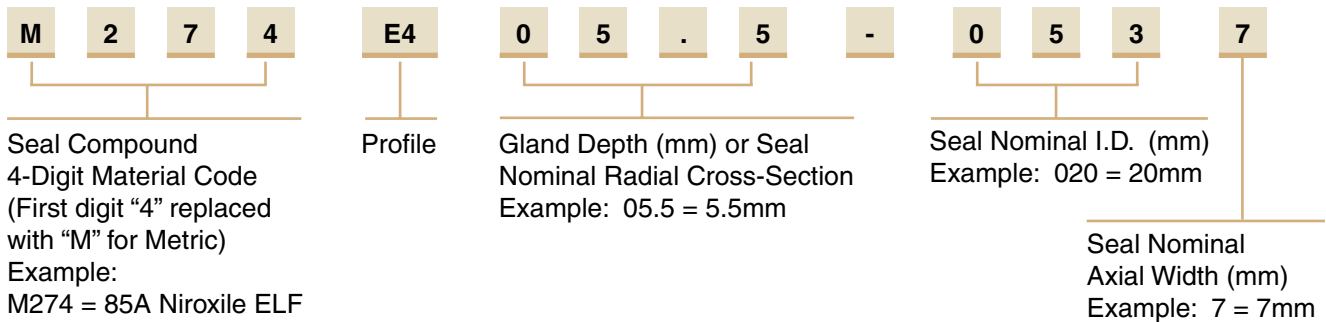

7

**Gland Dimensions — E4 Profile**

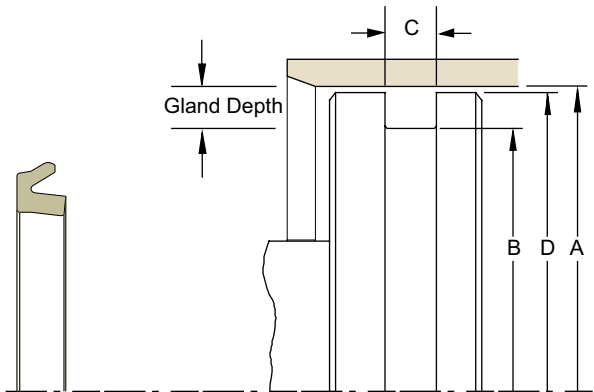

Please refer to Engineering Section 2,  
Page 2-8 for surface finish and additional  
hardware considerations.

**Table 7-27. E4 Gland Dimensions — Metric (mm)**

A Bore Diameter	B Groove Diameter	C Groove Width	D Piston Diameter*	Compound Code				Part Number	
				4180	4274	4208	5065	Compound Code	
H11	h9	+0.20/-00	f8						
43	33	7.5	43		X			XXXX	E405.0033-7
45	37	4.5	45		X			XXXX	E404.0037-4
63	53	7.5	63		X			XXXX	E405.0053-7
200	190	15	200			X		XXXX	E405.0190-14

\*If used with wear rings, refer to wear ring piston diameter, see Section 9.

NOTE: For sizes larger than those shown in the table, please contact your local Parker Seal representative.

09/01/07





# Piston Seal BMP Profile

Catalog EPS 5370/USA



## BMP Profile, Rounded Lip Seal with Bumper Cushion

The Parker BMP profile is a low friction bumper and seal providing quiet deceleration and reduced end stroke noise in pneumatic piston applications. Designed to mount on the ends of the piston and to be used along with Parker's V6 profile cushion seal, the bumper pad absorbs the final inertia which prevents contact between the piston and tube ends. The BMP profile can also be used without cushion seals in less critical applications. The BMP profile has a rounded sealing edge which hydroplanes over pre-lubricated surfaces extending cycle life and reducing friction. The BMP profile is available in Parker proprietary Nitroxile compound, offering low friction and wear resistance, as well as fluorocarbon for extended temperature range.

## Technical Data

Standard Materials*	Temperature Range	Pressure Range†	Surface Speed
N4274A85	-10°F to 250°F (-23°C to 121°C)	250 psi (17 bar)	< 3 ft/s (1 m/s)
V4208A90	-5°F to 400°F (-21°C to 204°C)	250 psi (17 bar)	< 3 ft/s (1 m/s)

\***Alternate Materials:** For applications that may require an alternate material, please contact your local Parker Seal representative.

†**Pressure Range** without wear rings (see Table 2-4, page 2-5).



*BMP Cross-Section*

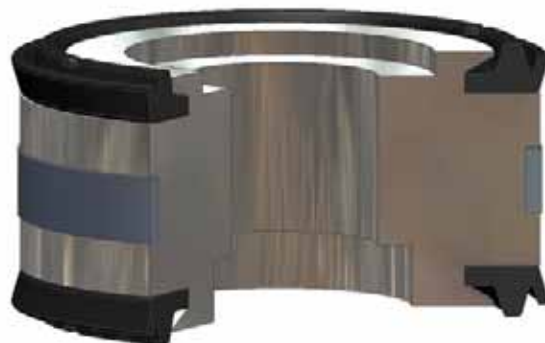

*BMP installed in Piston Gland*

7

09/01/07

**BMP Profile**

**Part Number Nomenclature — BMP Profile**

Table 7-28. BMP Profile — Inch

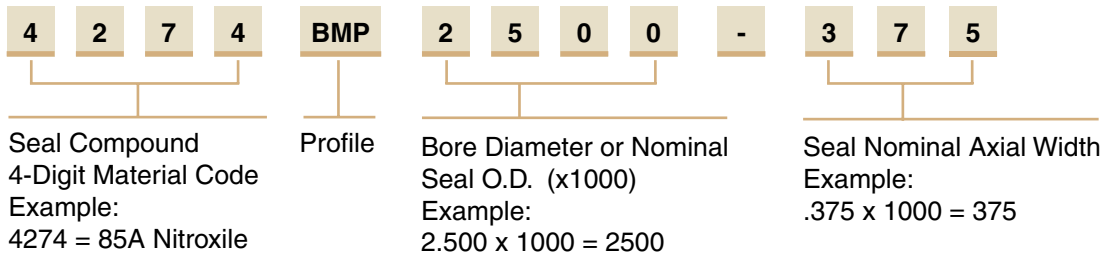

**Gland Dimensions — BMP Profile**

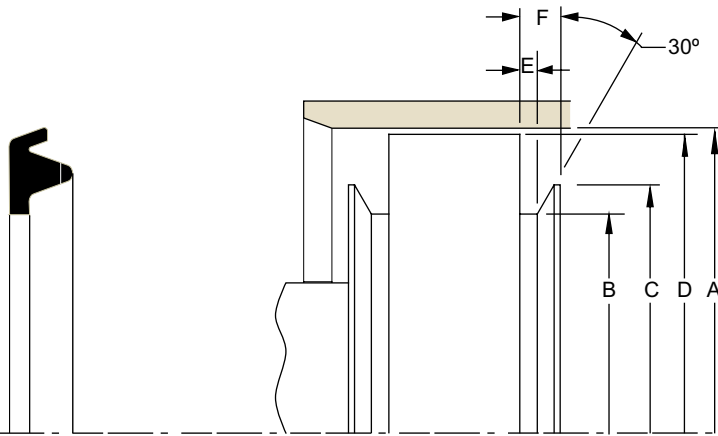

Please refer to Engineering Section 2, Page 2-8 for surface finish and additional hardware considerations.

Table 7-29. BMP Gland Dimensions — Inch

A Bore Diameter	B Groove Diameter	C Shoulder Diameter	D Piston Diameter*	E Groove Width	F Shoulder Height	Compound Codes		Part Number	
						4274	4208	Compound Code	
+0.002/-0.000	+0.000/-0.005	+0.000/-0.005	+0.000/-0.002	+0.005/-0.000	+0.005/-0.000				
1.125	0.639	0.851	1.123	0.110	0.204	X	X	XXXX	BMP1125-312
1.500	0.810	1.050	1.498	0.138	0.256	X	X	XXXX	BMP1500-312
2.000	1.202	1.440	1.998	0.138	0.256	X	X	XXXX	BMP2000-312
2.500	1.640	1.925	2.498	0.157	0.315	X	X	XXXX	BMP2500-375
3.250	2.150	2.550	3.248	0.157	0.315	X	X	XXXX	BMP3250-375
4.000	2.810	3.268	3.998	0.157	0.315	X	X	XXXX	BMP4000-375
5.000	3.525	4.095	4.998	0.157	0.315	X	X	XXXX	BMP5000-500

\*If used with wear rings, refer to wear ring piston diameter, see Section 9.

NOTE: For sizes larger than those shown in the table, please contact your local Parker Seal representative.

# Piston Seal TP Profile

Catalog EPS 5370/USA



## TP Profile (Piston T-seal), Compact Seal with Anti-Extrusion Technology

Parker's Piston T-seal is designed to retrofit o-rings in no back-up, single back-up and two back-up standard industrial reciprocating glands. Its compact design provides improved stability and extrusion resistance in dynamic fluid sealing applications. The flange or base of the T-seal forms a tight seal in the gland and supports the anti-extrusion back-up rings. When energized, the back-up rings bridge the extrusion gap to protect the rubber sealing element from extrusion and system contamination. The Piston T-seal eliminates the spiral or twisting failure that can occur when o-rings are used against a dynamic surface. Parker offers the Piston T-seal in a variety of elastomer and back-up ring compounds to cover a wide range of fluid compatibility, pressure and temperature.

Profile **TP0** for **no** back-up o-ring gland (standard offering)

Profile **TPS** for **single** back-up o-ring gland

Profile **TPT** for **two** back-up o-ring gland

The TP profile is sold only as an assembly (elastomer and back-up).

## Technical Data

### Standard Materials



TP Cross-Section

#### Base

Elastomer*	Temperature Range	Surface Speed
N4115A75	-40°F to 225°F (-40°C to 107°C)	< 1.6 ft/s (0.5 m/s)
N4274A85	-10°F to 250°F (-23°C to 121°C)	< 1.6 ft/s (0.5 m/s)
V4205A75	-20°F to 400°F (-29°C to 204°C)	< 1.6 ft/s (0.5 m/s)
E4259A80	-65°F to 300°F (-54°C to 149°C)	< 1.6 ft/s (0.5 m/s)

**\*Alternate Materials:** For applications that may require an alternate material, please see Section 3 for alternate elastomer materials.



TP installed in Piston Gland



09/01/07

**TP Profile**

**Technical Data (Continued)**

**Standard Materials**

**Back-up Rings\*\***

	<b>Temperature Range</b>	<b>Pressure Range†</b>
B001 Nylatron	-65°F to 250°F (-54°C to 121°C)	5,000 psi (344 bar)
B011 Virgin PTFE	-20°F to 250°F (-29°C to 121°C)	3,000 psi (206 bar)
B085 PEEK	-65°F to 500°F (-54°C to 260°C)	10,000 psi (689 bar)

\*\***Alternate Materials:** For applications that may require an alternate material, please see Section 3 for T-seal back-up materials.

†**Pressure Range** without wear rings (see Table 2-4, page 2-5).

**Part Number Nomenclature — T-seal Profile**

Table 7-30. T-seal Profile — Inch

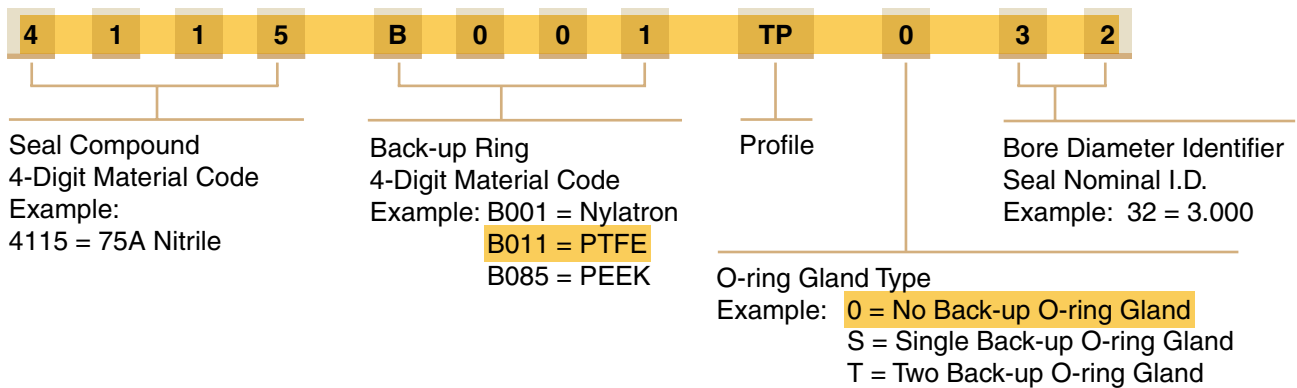

**7**

**Gland Dimensions — TP Profile**

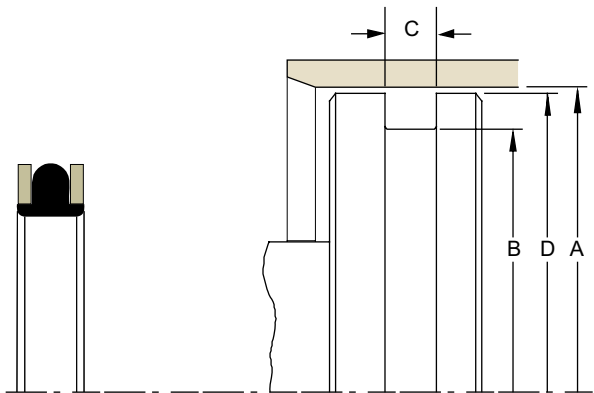

Please refer to Engineering Section 2, Page 2-8 for surface finish and additional hardware considerations.

Table 7-31. TP Gland Dimensions — Inch

A Bore Diameter	B Groove Diameter	C			D Piston Diameter*	Ref. O-ring Dash Number	Compound Code				Part Number			
		TP0 Groove Width	TPS Groove Width	TPT Groove Width			4115	4274	4205	4259	Compound Code	Back-up Ring Code	Groove Width Code**	Size Code
+0.002/ -0.000	+0.000/ -0.002	+0.005/ -0.000	+0.005/ -0.000	+0.005/ -0.000	+0.000/ -0.001									
0.374	0.198	0.140	0.171	0.238	0.372	106	X		X		XXXX	B0xx	TP0	01
0.437	0.261	0.140	0.171	0.238	0.435	108	X		X		XXXX	B0xx	TP0	02
0.499	0.323	0.140	0.171	0.238	0.497	109	X		X		XXXX	B0xx	TP0	03
0.562	0.320	0.187	0.208	0.275	0.559	203	X		X		XXXX	B0xx	TP0	04

\* If used with wear rings, refer to wear ring piston diameter, see Section 9.

\*\*Chart reflects availability for TP0 only. For availability of TPS and TPT contact your local Parker Seal representative.

Table 7-31. TP Gland Dimensions — Inch (Continued)

A Bore Diameter	B Groove Diameter	C			D Piston Diameter*	Ref. O-ring Dash Number	Compound Code				Part Number			
		TP0 Groove Width	TPS Groove Width	TPT Groove Width			4115	4274	4205	4259	Compound Code	Back-up Ring Code	Groove Width Code**	Size Code
+0.002/ -.000	+0.000/ -.002	+0.005/ -.000	+0.005/ -.000	+0.005/ -.000	+0.000/ -.001									
0.625	0.383	0.187	0.208	0.275	0.662	204	X		X		XXXX	B0xx	TP0	05
0.687	0.445	0.187	0.208	0.275	0.684	205	X		X		XXXX	B0xx	TP0	06
0.750	0.508	0.187	0.208	0.275	0.747	206	X		X	X	XXXX	B0xx	TP0	07
0.812	0.570	0.187	0.208	0.275	0.809	207	X		X		XXXX	B0xx	TP0	08
0.875	0.633	0.187	0.208	0.275	0.872	208	X		X	X	XXXX	B0xx	TP0	09
0.937	0.695	0.187	0.208	0.275	0.934	209	X				XXXX	B0xx	TP0	10
1.000	0.758	0.187	0.208	0.275	0.997	210	X	X	X	X	XXXX	B0xx	TP0	11
1.062	0.820	0.187	0.208	0.275	1.059	211	X		X	X	XXXX	B0xx	TP0	12
1.125	0.833	0.187	0.208	0.275	1.122	212	X	X	X	X	XXXX	B0xx	TP0	13
1.187	0.945	0.187	0.208	0.275	1.184	213	X		X		XXXX	B0xx	TP0	14
1.250	1.008	0.187	0.208	0.275	1.247	214	X		X		XXXX	B0xx	TP0	15
1.312	1.070	0.187	0.208	0.275	1.309	215	X		X		XXXX	B0xx	TP0	16
1.375	1.133	0.187	0.208	0.275	1.372	216	X		X	X	XXXX	B0xx	TP0	17
1.437	1.195	0.187	0.208	0.275	1.434	217	X		X		XXXX	B0xx	TP0	18
1.500	1.258	0.187	0.208	0.275	1.497	218	X	X	X	X	XXXX	B0xx	TP0	19
1.562	1.320	0.187	0.208	0.275	1.559	219	X				XXXX	B0xx	TP0	20
1.625	1.383	0.187	0.208	0.275	1.622	220	X	X	X		XXXX	B0xx	TP0	21
1.750	1.508	0.187	0.208	0.275	1.747	222	X	X	X	X	XXXX	B0xx	TP0	22
1.875	1.505	0.281	0.311	0.410	1.872	325	X	X	X	X	XXXX	B0xx	TP0	23
2.000	1.630	0.281	0.311	0.410	1.997	326	X	X	X	X	XXXX	B0xx	TP0	24
2.125	1.755	0.281	0.311	0.410	2.122	327	X		X	X	XXXX	B0xx	TP0	25
2.250	1.880	0.281	0.311	0.410	2.247	328	X		X		XXXX	B0xx	TP0	26
2.375	2.005	0.281	0.311	0.410	2.372	329	X		X		XXXX	B0xx	TP0	27
2.500	2.130	0.281	0.311	0.410	2.497	330	X	X	X	X	XXXX	B0xx	TP0	28
2.625	2.255	0.281	0.311	0.410	2.622	331	X		X	X	XXXX	B0xx	TP0	29
2.750	2.380	0.281	0.311	0.410	2.747	332	X		X		XXXX	B0xx	TP0	30
2.875	2.505	0.281	0.311	0.410	2.872	333	X		X	X	XXXX	B0xx	TP0	31
3.000	2.630	0.281	0.311	0.410	2.997	334	X	X	X		XXXX	B0xx	TP0	32
3.125	2.755	0.281	0.311	0.410	3.122	335	X		X		XXXX	B0xx	TP0	33
3.250	2.880	0.281	0.311	0.410	3.247	336	X	X	X	X	XXXX	B0xx	TP0	34
3.500	3.130	0.281	0.311	0.410	3.497	338	X	X	X	X	XXXX	B0xx	TP0	35
3.625	3.255	0.281	0.311	0.410	3.622	339	X		X		XXXX	B0xx	TP0	36
3.750	3.380	0.281	0.311	0.410	3.747	340	X		X		XXXX	B0xx	TP0	37
3.875	3.505	0.281	0.311	0.410	3.872	341	X		X		XXXX	B0xx	TP0	38
4.000	3.630	0.281	0.311	0.410	3.997	342	X	X	X	X	XXXX	B0xx	TP0	39
4.125	3.755	0.281	0.311	0.410	4.122	343	X		X	X	XXXX	B0xx	TP0	40
4.250	3.880	0.281	0.311	0.410	4.247	344	X	X	X		XXXX	B0xx	TP0	41
4.375	4.005	0.281	0.311	0.410	4.372	345	X		X		XXXX	B0xx	TP0	42
4.500	4.130	0.281	0.311	0.410	4.497	346	X	X	X	X	XXXX	B0xx	TP0	43
4.625	4.255	0.281	0.311	0.410	4.622	347	X				XXXX	B0xx	TP0	44
4.750	4.380	0.281	0.311	0.410	4.747	348	X	X	X	X	XXXX	B0xx	TP0	45
4.875	4.505	0.281	0.311	0.410	4.872	349	X		X		XXXX	B0xx	TP0	46
5.002	4.630	0.281	0.311	0.410	4.997	350	X	X	X		XXXX	B0xx	TP0	47
5.127	4.653	0.375	0.408	0.538	5.123	426	X		X		XXXX	B0xx	TP0	48
5.252	4.778	0.375	0.408	0.538	5.248	427	X	X	X		XXXX	B0xx	TP0	49
5.377	4.903	0.375	0.408	0.538	5.373	428	X	X	X		XXXX	B0xx	TP0	50

\* If used with wear rings, refer to wear ring piston diameter, see Section 9.

\*\*Chart reflects availability for TP0 only. For availability of TPS and TPT contact your local Parker Seal representative.

7

Table 7-31. TP Gland Dimensions — Inch (Continued)

A Bore Diameter	B Groove Diameter	C			D Piston Diameter*	Ref. O-ring Dash Number	Compound Code				Part Number						
		TP0 Groove Width	TPS Groove Width	TPT Groove Width			4115	4274	4205	4259	Compound Code	Back-up Ring Code	Groove Width Code**	Size Code			
+0.002/ -0.000	+0.000/ -0.002	+0.005/ -0.000	+0.005/ -0.000	+0.005/ -0.000	+0.000/ -0.001												
5.502	5.028	0.375	0.408	0.538	5.498	429	X	X		X	XXXX	B0xx	TP0	51			
5.627	5.153	0.375	0.408	0.538	5.623	430	X				XXXX	B0xx	TP0	52			
5.752	5.278	0.375	0.408	0.538	5.748	431	X	X	X	X	XXXX	B0xx	TP0	53			
5.877	5.403	0.375	0.408	0.538	5.873	432	X				XXXX	B0xx	TP0	54			
6.002	5.528	0.375	0.408	0.538	5.998	433	X	X	X		XXXX	B0xx	TP0	55			
6.127	5.653	0.375	0.408	0.538	6.123	434	X				XXXX	B0xx	TP0	56			
6.252	5.778	0.375	0.408	0.538	6.248	435	X				XXXX	B0xx	TP0	57			
6.502	6.028	0.375	0.408	0.538	6.498	437	X		X		XXXX	B0xx	TP0	58			
6.752	6.278	0.375	0.408	0.538	6.748	438	X		X		XXXX	B0xx	TP0	59			
7.002	6.528	0.375	0.408	0.538	6.998	439	X		X		XXXX	B0xx	TP0	60			
7.252	6.778	0.375	0.408	0.538	7.248	440	X		X		XXXX	B0xx	TP0	61			
7.502	7.028	0.375	0.408	0.538	7.498	441	X			X	XXXX	B0xx	TP0	62			
7.752	7.278	0.375	0.408	0.538	7.748	442	X				XXXX	B0xx	TP0	63			
8.002	7.528	0.375	0.408	0.538	7.998	443	X	X	X		XXXX	B0xx	TP0	64			
8.252	7.778	0.375	0.408	0.538	8.248	444	X				XXXX	B0xx	TP0	65			
8.502	8.028	0.375	0.408	0.538	8.498	445	X		X		XXXX	B0xx	TP0	66			
9.002	8.528	0.375	0.408	0.538	8.998	446	X				XXXX	B0xx	TP0	67			
9.502	9.028	0.375	0.408	0.538	9.498	447	X				XXXX	B0xx	TP0	68			
10.002	9.528	0.375	0.408	0.538	9.998	448	X				XXXX	B0xx	TP0	69			
10.502	10.028	0.375	0.408	0.538	10.498	449	X				XXXX	B0xx	TP0	70			
11.002	10.528	0.375	0.408	0.538	10.998	450	X				XXXX	B0xx	TP0	71			
11.502	11.028	0.375	0.408	0.538	11.498	451	X				XXXX	B0xx	TP0	72			
12.002	11.528	0.375	0.408	0.538	11.998	452	X		X		XXXX	B0xx	TP0	73			
14.002	13.528	0.375	0.408	0.538	13.998	456	X			X	XXXX	B0xx	TP0	77			
15.502	15.028	0.375	0.408	0.538	15.498	459	X				XXXX	B0xx	TP0	80			
16.002	15.528	0.375	0.408	0.538	15.998	460	X			X	XXXX	B0xx	TP0	81			
17.002	16.528	0.375	0.408	0.538	16.998	462	X				XXXX	B0xx	TP0	83			
17.502	17.028	0.375	0.408	0.538	17.498	463	X				XXXX	B0xx	TP0	84			
24.002	23.528	0.375	0.408	0.538	23.998	N/A	X		X	X	XXXX	B0xx	TP0	97			

\* If used with wear rings, refer to wear ring piston diameter, see Section 9.

\*\*Chart reflects availability for TP0 only. For availability of TPS and TPT contact your local Parker Seal representative.

NOTE: For sizes larger than those shown in the table, please contact your local Parker Seal representative.



# Piston Seal S5 Profile

Catalog EPS 5370/USA



## S5 Profile, Square PTFE Cap Seal

The Parker S5 profile is a bi-directional piston seal for use in low to medium duty hydraulic actuators and is suitable for sealing against hardened surfaces in pneumatic applications. The S5 profile is a two piece design comprised of a standard size Parker o-ring energizing a glass-filled PTFE cap. The S5 profile offers long wear, low friction and because of its short assembly length requires minimal gland space on the piston. The seal is commonly used in applications such as agriculture hydraulics, mobile hydraulics, machine tools, and hydraulic presses. Parker's S5 profile will retrofit non-Parker seals of similar design and is an updated version of the Parker S5000 piston seal.

The S5 profile may be ordered without the energizer by omitting the energizer code. See part number nomenclature.

### Technical Data

Standard Materials*	Temperature Range	Pressure Range†	Surface Speed
<b>Cap</b> 0203 15% fiberglass filled PTFE	-200°F to 575°F (-129°C to 302°C)	3500 psi (241 bar)	< 13 ft/s (4 m/sec)
<b>Energizer</b> A 70A Nitrile	-30°F to 250°F (-34°C to 121°C)		

**\*Alternate Materials:** For applications that may require an alternate material, please see Section 3 for alternate PTFE (Table 3-4) and energizer (Table 3-5) materials.

**†Pressure Range** without wear rings (see Table 2-4, page 2-5).

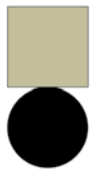

S5 Cross-Section

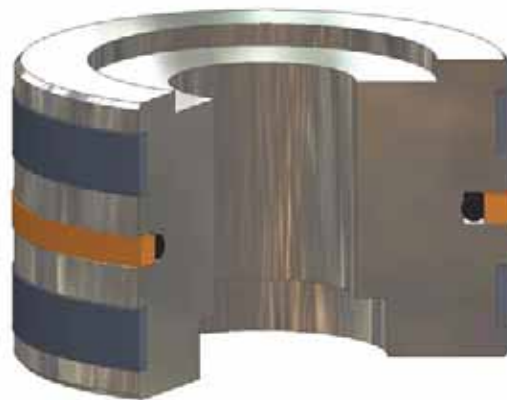

S5 installed in Piston Gland

7

09/01/07

## S5 Profile

### Technical Data (Continued)

#### Options

**Split Rings:** To aid in installation, the PTFE ring can be supplied in one of the following split configurations. To indicate that the S5 profile is to be split, add the appropriate split type indicator to the end of the part number.

- S = Step Cut
- T = Butt Cut
- V = Bevel cut

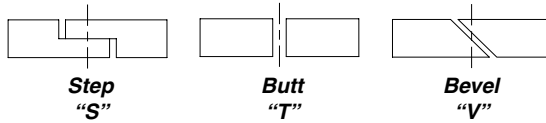

**Metric:** To configure metric part numbering, see Table 7-34 on page 7-38, and call your local Parker Seal representative for availability.

### Part Number Nomenclature — S5 Profile

Table 7-32. S5 Profile — Inch

0	2	0	3	S5	1	9	6	0	3	5	0	0	-	1	2	9	A
Seal Compound 4-Digit Material Code Example: 0203 = 15% Fiberglass-filled PTFE				Profile	Gland Depth (x1000) Example: .196 X 1000 = 196				Bore Diameter (x1000) Example: 3.500 X 1000 = 03500					Groove Width (x1000) Example: .129 X 1000 = 129			Energizer Material Code A = 70A Nitrile Omit = No energizer See Table 3-5, page 3-18
Option: Split Ring Options																	
S = Step Cut <input type="checkbox"/>																	
T = Butt Cut <input type="checkbox"/>																	
V = Bevel Cut <input type="checkbox"/>																	

### Gland Dimensions — S5 Profile

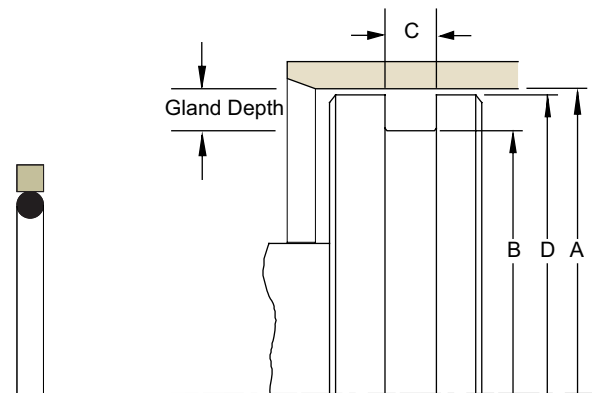

Please refer to Engineering Section 2, Page 2-8 for surface finish and additional hardware considerations.

Table 7-33. S5 Gland Dimensions — Inch

A Bore Diameter	B Groove Diameter	C Groove Width	D Piston Diameter*	O-ring Dash Number	Part Number
+0.002/-0.000	+0.001/-0.001	+0.002/-0.002	+0.000/-0.002		
0.500	0.240	0.083	0.499	009	0203S513000500-083A
0.625	0.365	0.083	0.624	011	0203S513000625-083A
0.750	0.490	0.083	0.749	013	0203S513000750-083A

\*If used with wear rings, refer to wear ring piston diameter, see Section 9.

Table 7-33. S5 Gland Dimensions — Inch (Continued)

A Bore Diameter	B Groove Diameter	C Groove Width	D Piston Diameter*	O-ring Dash Number	Part Number
<b>+0.002/-0.000</b>	<b>+0.001/-0.001</b>	<b>+0.002/-0.002</b>	<b>+0.000/-0.002</b>		
0.875	0.615	0.083	0.874	016	0203S513000875-083A
1.000	0.740	0.083	0.999	017	0203S513001000-083A
1.125	0.865	0.083	1.124	019	0203S513001125-083A
1.250	0.990	0.083	1.249	022	0203S513001250-083A
1.375	1.115	0.083	1.374	022	0203S513001375-083A
1.500	1.240	0.083	1.499	025	0203S513001500-083A
<b>+0.002/-0.000</b>	<b>+0.002/-0.002</b>	<b>+0.002/-0.002</b>	<b>+0.000/-0.002</b>		
1.625	1.233	0.122	1.624	123	0203S519601625-122A
1.750	1.358	0.122	1.749	125	0203S519601750-122A
1.875	1.483	0.122	1.874	127	0203S519601875-122A
<b>+0.003/-0.000</b>	<b>+0.002/-0.002</b>	<b>+0.003/-0.003</b>	<b>+0.000/-0.003</b>		
2.000	1.608	0.130	1.999	129	0203S519602000-130A
2.125	1.733	0.130	2.14	131	0203S519602125-130A
2.250	1.858	0.130	2.249	133	0203S519602250-130A
2.375	1.983	0.130	2.374	135	0203S519602375-130A
2.500	2.108	0.130	2.499	137	0203S519602500-130A
2.625	2.233	0.130	2.624	139	0203S519602625-130A
2.750	2.358	0.130	2.749	141	0203S519602750-130A
2.875	2.483	0.130	2.874	143	0203S519602875-130A
3.000	2.608	0.130	2.999	145	0203S519603000-130A
3.250	2.858	0.130	3.249	149	0203S519603250-130A
3.375	2.983	0.130	3.374	150	0203S519603375-130A
3.500	3.108	0.130	3.499	151	0203S519603500-130A
3.625	3.233	0.130	3.624	152	0203S519603625-130A
3.750	3.358	0.130	3.749	152	0203S519603750-130A
4.000	3.608	0.130	3.999	153	0203S519604000-130A
4.250	3.858	0.130	4.249	154	0203S519604250-130A
4.500	4.108	0.130	4.499	155	0203S519604500-130A
4.750	4.358	0.130	4.749	156	0203S519604750-130A
4.875	4.483	0.130	4.874	156	0203S519604875-130A
5.000	4.608	0.130	4.999	157	0203S519605000-130A
5.250	4.858	0.130	5.249	158	0203S519605250-130A
5.500	5.108	0.130	5.499	159	0203S519605500-130A
<b>+0.004/-0.000</b>	<b>+0.003/-0.003</b>	<b>+0.004/-0.004</b>	<b>+0.000/-0.003</b>		
5.750	5.232	0.160	5.748	251	0203S525905750-160A
5.875	5.357	0.160	5.873	252	0203S525905875-160A
6.000	5.482	0.160	5.998	253	0203S525906000-160A
6.250	5.732	0.160	6.248	255	0203S525906250-160A
6.500	5.982	0.160	6.498	257	0203S525906500-160A
6.750	6.232	0.160	6.748	258	0203S525906750-160A
7.000	6.482	0.160	6.998	259	0203S525907000-160A
7.125	6.607	0.160	7.123	260	0203S525907125-160A
7.250	6.732	0.160	7.248	260	0203S525907250-160A
7.500	6.982	0.160	7.498	261	0203S525907500-160A
7.750	7.232	0.160	7.748	262	0203S525907750-160A
8.000	7.482	0.160	7.998	263	0203S525908000-160A
8.250	7.732	0.160	8.248	264	0203S525908250-160A
8.500	7.982	0.160	8.498	265	0203S525908500-160A
8.750	8.232	0.160	8.748	266	0203S525908750-160A
9.000	8.482	0.160	8.998	267	0203S525909000-160A

\*If used with wear rings, refer to wear ring piston diameter, see Section 9.

09/01/07



**S5 Profile**

**Table 7-33. S5 Gland Dimensions — Inch (Continued)**

A Bore Diameter	B Groove Diameter	C Groove Width	D Piston Diameter*	O-ring Dash Number	Part Number
<b>+.004/-0.000</b>	<b>+.003/-0.003</b>	<b>+.004/-0.004</b>	<b>+.000/-0.003</b>		
9.250	8.732	0.160	9.248	268	<b>0203S525909250-160A</b>
9.500	8.982	0.160	9.498	269	<b>0203S525909500-160A</b>
9.750	9.232	0.160	9.748	270	<b>0203S525909750-160A</b>
10.000	9.482	0.160	9.998	271	<b>0203S525910000-160A</b>
10.250	9.732	0.160	10.248	272	<b>0203S525910250-160A</b>
10.500	9.982	0.160	10.498	273	<b>0203S525910500-160A</b>
10.750	10.232	0.160	10.748	274	<b>0203S525910750-160A</b>
11.000	10.482	0.160	10.998	275	<b>0203S525911000-160A</b>
11.500	10.982	0.160	11.498	276	<b>0203S525911500-160A</b>
12.000	11.482	0.160	11.998	277	<b>0203S525912000-160A</b>
12.500	11.982	0.160	12.498	278	<b>0203S525912500-160A</b>
13.000	12.482	0.160	12.998	278	<b>0203S525913000-160A</b>
14.000	13.482	0.160	13.998	279	<b>0203S525914000-160A</b>
15.000	14.482	0.160	14.998	280	<b>0203S525915000-160A</b>
16.000	15.482	0.160	15.998	281	<b>0203S525916000-160A</b>

\*If used with wear rings, refer to wear ring piston diameter, see Section 9.

NOTE: For sizes larger than those shown in the table, please contact your local Parker Seal representative.

**Part Number Nomenclature — S5 Profile**

**Table 7-34. S5 Profile — Metric (mm)**

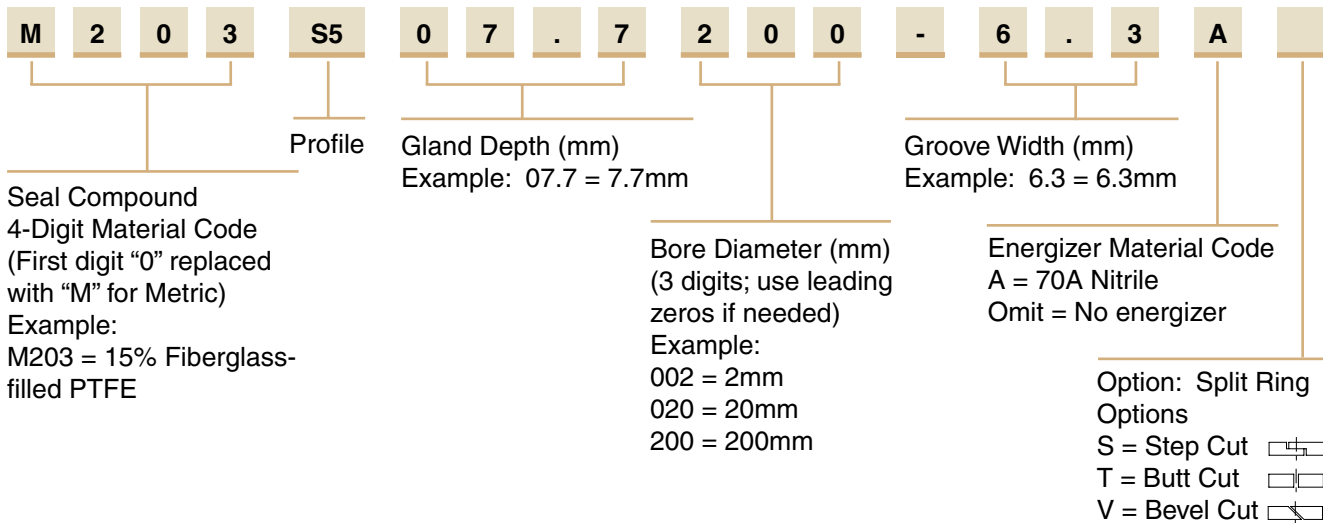

# Piston Seal R5 Profile

Catalog EPS 5370/USA



## R5 Profile, Rectangular PTFE Cap Seal

The Parker R5 profile is a bi-directional piston seal for use in medium to heavy duty hydraulic actuators and is suitable for sealing against hardened surfaces in pneumatic applications. The R5 profile is a two piece design comprised of a standard size rubber square ring energizing a rectangular shaped PTFE cap. The R5 profile offers excellent stability, long wear, low friction and extrusion protection. The seal is commonly used in applications such as agriculture hydraulics, mobile hydraulics, machine tools and hydraulic presses. Parker's R5 profile will retrofit non-Parker seals of similar design and is an updated version of the Parker R5100 piston seal.

The R5 profile may be ordered without the energizer by omitting the energizer code. See part number nomenclature.

### Technical Data

Standard Materials*		Temperature Range	Pressure Range†	Surface Speed
<b>Cap</b>				
0203	15% fiberglass filled PTFE	-200°F to 575°F (-129°C to 302°C)	3500 psi (241 bar)	< 13 ft/s (4 m/sec)
<b>Energizer</b>				
A	70A Nitrile	-30°F to 250°F (-34°C to 121°C)		

**\*\*Alternate Materials:** For applications that may require an alternate material, please see Section 3 for alternate PTFE (Table 4) and energizer (Table 3-5) materials.

**†Pressure Range** without wear rings (see Table 2-4, page 2-5).



R5 Cross-Section

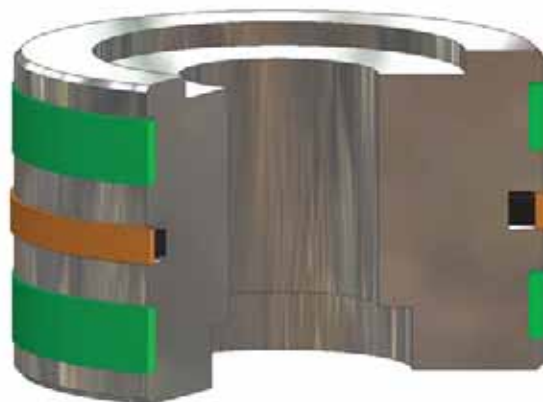

R5 installed in Piston Gland

7

09/01/07

## R5 Profile

### Technical Data (Continued)

#### Options

**Split Rings:** To aid in installation, the PTFE ring can be supplied in one of the following split configurations. To indicate that the R5 profile is to be split, add the appropriate split type indicator to the end of the part number.

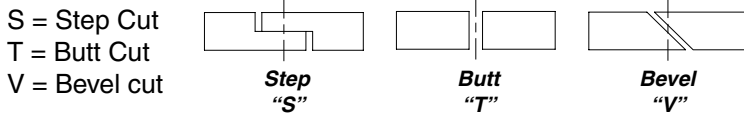

**Metric:** To configure metric part numbering, see Table 7-37 on page 7-42, and call your local Parker Seal representative for availability.

### Part Number Nomenclature — R5 Profile

Table 7-35. R5 Profile — Inch

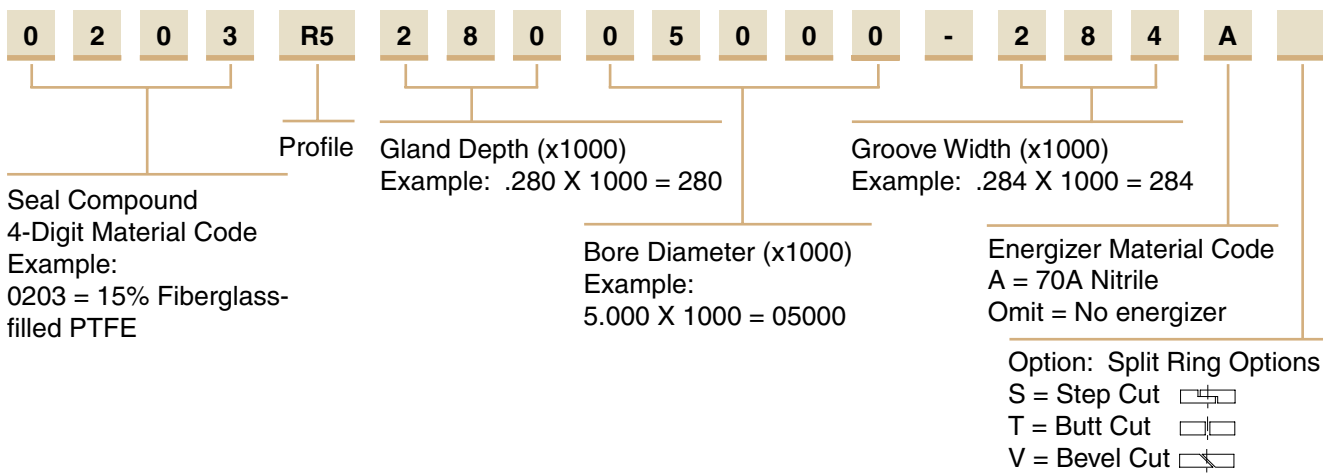

### Gland Dimensions — R5 Profile

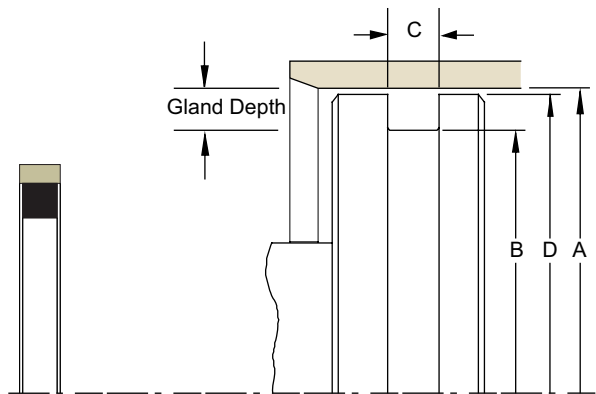

Please refer to Engineering Section 2, Page 2-8 for surface finish and additional hardware considerations.

Table 7-36. R5 Gland Dimensions — Inch

A Bore Diameter	B Groove Diameter	C Groove Width	D Piston Diameter*	O-ring Dash Number	Part Number
+0.002/-0.000	+0.001/-0.001	+0.002/-0.002	+0.000/-0.001		
1.000	0.692	0.129	0.999	115	0203R515501000-129A
1.250	0.942	0.129	1.249	119	0203R515501250-129A
1.500	1.192	0.129	1.499	123	0203R515501500-129A

\*If used with wear rings, refer to wear ring piston diameter, see Section 9.



Table 7-36. R5 Gland Dimensions — Inch (Continued)

A Bore Diameter	B Groove Diameter	C Groove Width	D Piston Diameter*	O-ring Dash Number	Part Number
<b>+.002/- .000</b>	<b>+.001/- .001</b>	<b>+.002/- .002</b>	<b>+.000/- .001</b>		
1.750	1.442	0.129	1.749	127	0203R515501750-129A
2.000	1.692	0.129	1.999	131	0203R515502000-129A
2.250	1.942	0.129	2.249	135	0203R515502250-129A
2.500	2.192	0.129	2.499	139	0203R515502500-129A
2.750	2.442	0.129	2.749	143	0203R515502750-129A
<b>+.003/- .000</b>	<b>+.002/- .002</b>	<b>+.003/- .003</b>	<b>+.000/- .002</b>		
3.000	2.444	0.284	2.998	333	0203R528003000-284A
3.250	2.694	0.284	3.248	335	0203R528003250-284A
3.500	2.944	0.284	3.498	337	0203R528003500-284A
3.750	3.194	0.284	3.748	339	0203R528003750-284A
4.000	3.444	0.284	3.998	341	0203R528004000-284A
4.125	3.569	0.284	4.123	342	0203R528004125-284A
4.250	3.694	0.284	4.248	343	0203R528004250-284A
4.500	3.944	0.284	4.498	345	0203R528004500-284A
4.750	4.194	0.284	4.748	347	0203R528004750-284A
5.000	4.444	0.284	4.998	349	0203R528005000-284A
<b>+.004/- .000</b>	<b>+.003/- .003</b>	<b>+.004/- .004</b>	<b>+.000/- .003</b>		
5.250	4.488	0.379	5.247	425	0203R538105250-379A
5.500	4.738	0.379	5.497	427	0203R538105500-379A
5.750	4.988	0.379	5.747	429	0203R538105750-379A
6.000	5.238	0.379	5.997	431	0203R538106000-379A
6.250	5.488	0.379	6.247	433	0203R538106250-379A
6.500	5.738	0.379	6.497	435	0203R538106500-379A
6.750	5.988	0.379	6.747	437	0203R538106750-379A
7.000	6.238	0.379	6.997	438	0203R538107000-379A
7.250	6.488	0.379	7.247	439	0203R538107250-379A
7.500	6.738	0.379	7.497	440	0203R538107500-379A
7.750	6.988	0.379	7.747	441	0203R538107750-379A
8.000	7.238	0.379	7.997	442	0203R538108000-379A
8.250	7.488	0.379	8.247	443	0203R538108250-379A
8.500	7.738	0.379	8.497	444	0203R538108500-379A
<b>+.004/- .000</b>	<b>+.004/- .004</b>	<b>+.004/- .004</b>	<b>+.000/- .004</b>		
9.000	8.122	0.379	8.996	445	0203R543909000-379A
9.500	8.622	0.379	9.496	446	0203R543909500-379A
10.000	9.122	0.379	9.996	447	0203R543910000-379A
11.000	10.122	0.379	10.996	449	0203R543911000-379A
12.000	11.122	0.379	11.996	451	0203R543912000-379A
13.000	12.122	0.379	12.996	453	0203R543913000-379A
14.000	13.122	0.379	13.996	455	0203R543914000-379A

\*If used with wear rings, refer to wear ring piston diameter, see Section 9.

NOTE: For sizes larger than those shown in the table, please contact your local Parker Seal representative.



## R5 Profile

### Part Number Nomenclature — R5 Profile

Table 7-37. R5 Profile — Metric (mm)

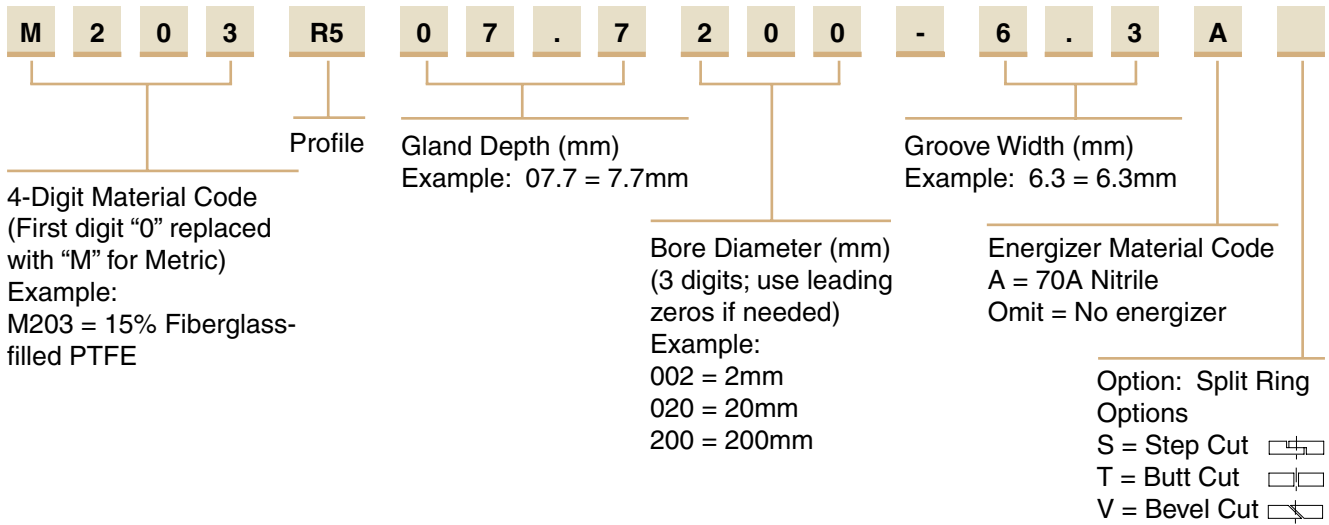

# Piston Seal CT Profile

Catalog EPS 5370/USA

## CT Profile, Premium PTFE Cap Seal with Anti-Extrusion Technology



The Parker CT Profile is a robust design for heavy duty hydraulic applications. The CT Profile is an excellent choice for sealing mobile hydraulic applications that experience shock loads. The CT profile is a four piece assembly made up of a rubber energizer, PTFE cap and two back-up rings. In application, fluid pressure forces the rubber energizer to apply increased load against the PTFE cap and back-up rings. This results in increased sealing force against the bore and allows the back-up rings to close off the extrusion gap between the piston and the bore. Once activated by pressure, the back-up rings protect the seal from extruding and keep internal contamination away from the PTFE cap. Parker's CT profile will retrofit non-Parker seals of similar design.

The CT Profile is sold only as an assembly (seal and energizer). See part number nomenclature.

### Technical Data

Standard Materials*	Temperature Range**	Surface Speed
<b>Cap</b> 0401 40% bronze filled PTFE	-200°F to 575°F (-129°C to 302°C)	< 5 ft/s (1.5 m/sec)
<b>Energizer</b> A 70A Nitrile	-30°F to 250°F (-34°C to 121°C)	

**\*Alternate Materials:** For applications that may require an alternate material, please see Section 3 for alternate PTFE, energizer and back-up materials.

**\*\*The temperature range of the CT profile is limited to the energizer.** A wider temperature range can be achieved by using alternate energizer and back-up ring compounds.



CT Cross-Section  
Standard



CT installed in Piston Gland

7

09/01/07

**CT Profile**

**Technical Data (Continued)**

**Standard Materials\***

Back-up Rings	Temperature Range	Pressure Range†
B001 Nylatron	-65°F to 250°F (-44°C to 121°C)	7,500 psi (500 bar)

\***Alternate Materials:** For applications that may require an alternate material, please see Section 3 for alternate PTFE, energizer and back-up materials.

†**Pressure Range** without wear rings (see Table 2-4, page 2-5).

**Options**

**Metric:** To configure metric part numbering, see Table 7-41 on page 7-47, and call your local Parker Seal representative for availability.

**Part Number Nomenclature — CT Profile**

Table 7-38. CT Profile — Inch

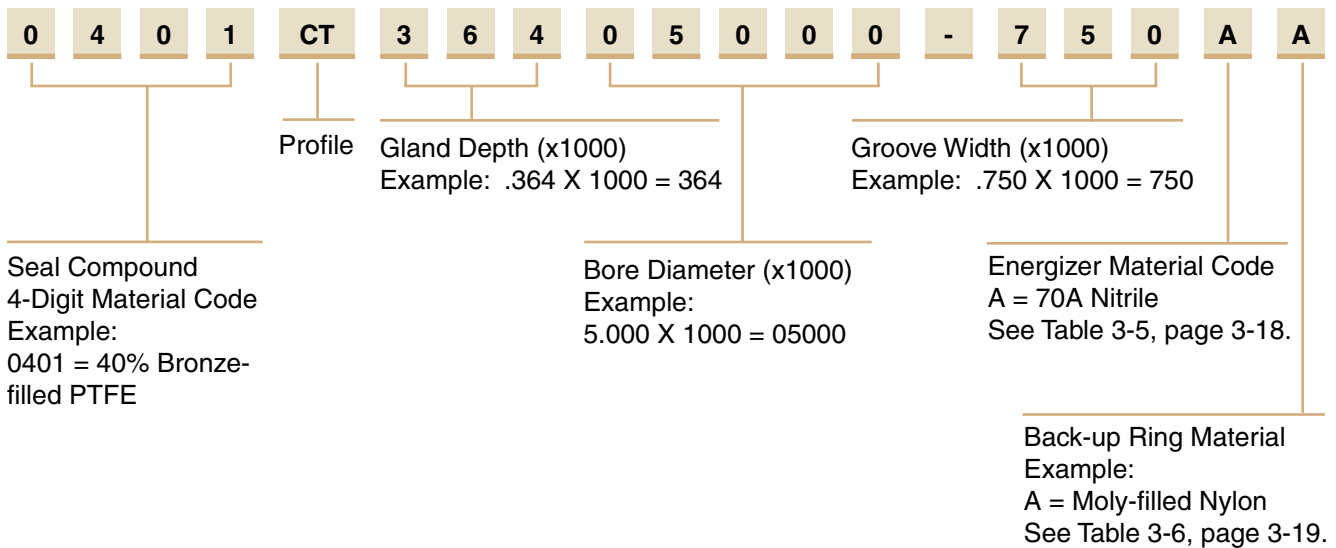

7

## Gland Dimensions — CT Profile

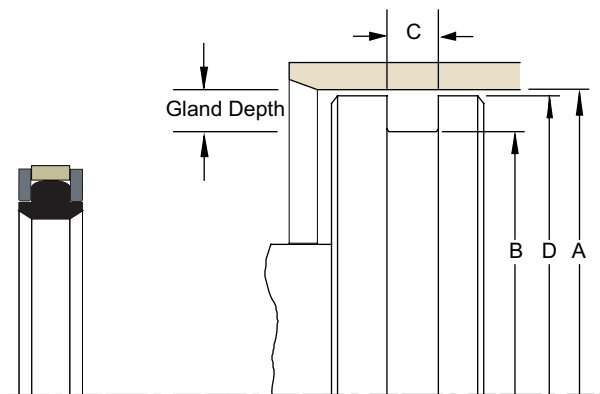

Please refer to Engineering Section 2, Page 2-8 for surface finish and additional hardware considerations.

Table 7-39. CT Gland Dimensions (Narrow Style) — Inch

A Bore Diameter	B Groove Diameter	C Groove Width	D Piston Diameter*	Part Number (Narrow Style)
<b>+ .002/- .000</b>	<b>+ .000/- .002</b>	<b>+ .010/- .000</b>	<b>+ .000/- .002</b>	
1.500	0.942	0.295	1.499	0401CT27901500-295AA
2.000	1.442	0.295	1.999	0401CT27902000-295AA
2.250	1.692	0.295	2.249	0401CT27902250-295AA
2.500	1.942	0.295	2.499	0401CT27902500-295AA
2.750	2.192	0.295	2.749	0401CT27902750-295AA
<b>+ .003/- .000</b>	<b>+ .000/- .002</b>	<b>+ .010/- .000</b>	<b>+ .000/- .002</b>	
3.000	2.442	0.420	2.998	0401CT27903000-420AA
3.250	2.692	0.420	3.248	0401CT27903250-420AA
3.500	2.942	0.420	3.498	0401CT27903500-420AA
3.750	3.192	0.420	3.748	0401CT27903750-420AA
4.000	3.442	0.420	3.998	0401CT27904000-420AA
4.250	3.692	0.420	4.248	0401CT27904250-420AA
4.500	3.942	0.420	4.498	0401CT27904500-420AA
4.750	4.192	0.420	4.748	0401CT27904750-420AA
5.000	4.442	0.420	4.998	0401CT27905000-420AA

\*If used with wear rings, refer to wear ring piston diameter, see Section 9.

NOTE: For sizes larger than those shown in the table, please contact your local Parker Seal representative.

Table 7-40. CT Gland Dimensions (Standard Style) — Inch

A Bore Diameter	B Groove Diameter	C Groove Width	D Piston Diameter*	Part Number (Standard Style)
<b>+ .002/- .000</b>	<b>+ .000/- .002</b>	<b>+ .010/- .000</b>	<b>+ .000/- .002</b>	
1.000	0.628	0.424	0.999	0401CT18601000-424AA
1.063	0.691	0.424	1.062	0401CT18601063-424AA
1.125	0.753	0.424	1.124	0401CT18601125-424AA
1.188	0.816	0.424	1.187	0401CT18601188-424AA
1.250	0.878	0.424	1.249	0401CT18601250-424AA
1.313	0.941	0.424	1.312	0401CT18601313-424AA
1.375	1.003	0.424	1.374	0401CT18601375-424AA
1.438	1.066	0.424	1.437	0401CT18601438-424AA
1.500	1.128	0.424	1.499	0401CT18601500-424AA
1.563	1.191	0.424	1.562	0401CT18601563-424AA
1.625	1.253	0.424	1.624	0401CT18601625-424AA
1.688	1.316	0.424	1.687	0401CT18601688-424AA
1.750	1.378	0.424	1.749	0401CT18601750-424AA
1.875	1.503	0.424	1.874	0401CT18601875-424AA

\*If used with wear rings, refer to wear ring piston diameter, see Section 9.

09/01/07

**Table 7-40. CT Gland Dimensions (Standard Style) — Inch (Continued)**

A Bore Diameter	B Groove Diameter	C Groove Width	D Piston Diameter*	Part Number (Standard Style)
<b>+0.003/-0.000</b>	<b>+0.000/-0.003</b>	<b>+0.010/-0.000</b>	<b>+0.000/-0.003</b>	
2.000	1.628	0.424	1.999	0401CT18602000-424AA
2.125	1.753	0.424	2.124	0401CT18602125-424AA
2.250	1.878	0.424	2.249	0401CT18602250-424AA
2.375	2.003	0.424	2.374	0401CT18602375-424AA
2.500	2.128	0.424	2.499	0401CT18602500-424AA
2.625	2.253	0.424	2.624	0401CT18602625-424AA
2.750	2.378	0.424	2.749	0401CT18602750-424AA
2.875	2.503	0.424	2.874	0401CT18602875-424AA
<b>+0.004/-0.000</b>	<b>+0.000/-0.003</b>	<b>+0.010/-0.000</b>	<b>+0.000/-0.003</b>	
3.000	2.522	0.579	2.998	0401CT23903000-579AA
3.125	2.647	0.579	3.123	0401CT23903125-579AA
3.250	2.772	0.579	3.248	0401CT23903250-579AA
3.375	2.897	0.579	3.373	0401CT23903375-579AA
3.500	3.022	0.579	3.498	0401CT23903500-579AA
3.625	3.147	0.579	3.623	0401CT23903625-579AA
3.750	3.272	0.579	3.748	0401CT23903750-579AA
3.875	3.397	0.579	3.873	0401CT23903875-579AA
4.000	3.522	0.579	3.998	0401CT23904000-579AA
4.125	3.647	0.579	4.123	0401CT23904125-579AA
4.250	3.772	0.579	4.248	0401CT23904250-579AA
4.375	3.897	0.579	4.373	0401CT23904375-579AA
4.500	4.022	0.579	4.498	0401CT23904500-579AA
4.625	4.147	0.579	4.623	0401CT23904625-579AA
4.750	4.272	0.579	4.748	0401CT23904750-579AA
4.875	4.397	0.579	4.873	0401CT23904875-579AA
5.000	4.272	0.750	4.998	0401CT36405000-750AA
5.125	4.397	0.750	5.123	0401CT36405125-750AA
5.250	4.522	0.750	5.248	0401CT36405250-750AA
5.375	4.647	0.750	5.373	0401CT36405375-750AA
<b>+0.004/-0.000</b>	<b>+0.000/-0.004</b>	<b>+0.010/-0.000</b>	<b>+0.000/-0.004</b>	
5.500	4.772	0.750	5.497	0401CT36405500-750AA
5.625	4.897	0.750	5.622	0401CT36405625-750AA
5.750	5.022	0.750	5.747	0401CT36405750-750AA
5.875	5.147	0.750	5.872	0401CT36405875-750AA
6.000	5.272	0.750	5.997	0401CT36406000-750AA
6.125	5.397	0.750	6.122	0401CT36406125-750AA
6.250	5.522	0.750	6.247	0401CT36406250-750AA
6.375	5.647	0.750	6.372	0401CT36406375-750AA
6.500	5.772	0.750	6.497	0401CT36406500-750AA
6.750	6.022	0.750	6.747	0401CT36406750-750AA
7.000	6.272	0.750	6.997	0401CT36407000-750AA
<b>+0.005/-0.000</b>	<b>+0.000/-0.004</b>	<b>+0.010/-0.000</b>	<b>+0.000/-0.004</b>	
7.250	6.522	0.750	7.247	0401CT36407250-750AA
7.500	6.772	0.750	7.497	0401CT36407500-750AA
7.750	7.022	0.750	7.747	0401CT36407750-750AA
<b>+0.005/-0.000</b>	<b>+0.000/-0.005</b>	<b>+0.010/-0.000</b>	<b>+0.000/-0.005</b>	
8.000	7.272	0.750	7.996	0401CT36408000-750AA
8.250	7.522	0.750	8.246	0401CT36408250-750AA
8.500	7.772	0.750	8.496	0401CT36408500-750AA

\*If used with wear rings, refer to wear ring piston diameter, see Section 9.





**Table 7-40. CT Gland Dimensions (Standard Style) — Inch (Continued)**

A Bore Diameter	B Groove Diameter	C Groove Width	D Piston Diameter*	Part Number (Standard Style)
<b>+ .005/- .000</b>	<b>+ .000/- .005</b>	<b>+ .010/- .000</b>	<b>+ .000/- .005</b>	
8.750	8.022	0.750	8.746	0401CT36408750-750AA
9.000	8.272	0.750	8.996	0401CT36409000-750AA
9.500	8.772	0.750	9.496	0401CT36409500-750AA
10.000	9.272	0.750	9.996	0401CT36410000-750AA
10.500	9.772	0.750	10.496	0401CT36410500-750AA
11.000	10.272	0.750	10.996	0401CT36411000-750AA
11.500	10.772	0.750	11.496	0401CT36411500-750AA
12.000	11.272	0.750	11.996	0401CT36412000-750AA
<b>+ .006/- .000</b>	<b>+ .000/- .005</b>	<b>+ .010/- .000</b>	<b>+ .000/- .005</b>	
12.500	11.772	0.750	12.496	0401CT36412500-750AA
13.000	12.272	0.750	12.996	0401CT36413000-750AA
<b>+ .006/- .000</b>	<b>+ .000/- .006</b>	<b>+ .010/- .000</b>	<b>+ .000/- .006</b>	
13.500	12.772	0.750	13.495	0401CT36413500-750AA
14.000	13.272	0.750	13.995	0401CT36414000-750AA
14.500	13.772	0.750	14.495	0401CT36414500-750AA
15.000	14.272	0.750	14.995	0401CT36415000-750AA
15.500	14.772	0.750	15.495	0401CT36415500-750AA
16.000	15.272	0.750	15.995	0401CT36416000-750AA
16.500	15.772	0.750	16.495	0401CT36416500-750AA
17.000	16.272	0.750	16.995	0401CT36417000-750AA
17.500	16.772	0.750	17.495	0401CT36417500-750AA
18.000	17.272	0.750	17.995	0401CT36418000-750AA
18.500	17.772	0.750	18.495	0401CT36418500-750AA
19.000	18.272	0.750	18.995	0401CT36419000-750AA
19.500	18.772	0.750	19.495	0401CT36419500-750AA
20.000	19.272	0.750	19.995	0401CT36420000-750AA

\*If used with wear rings, refer to wear ring piston diameter, see Section 9.

NOTE: For sizes larger than those shown in the table, please contact your local Parker Seal representative.

**Part Number Nomenclature — CT Profile**

**Table 7-41. CT Profile — Metric (mm)**

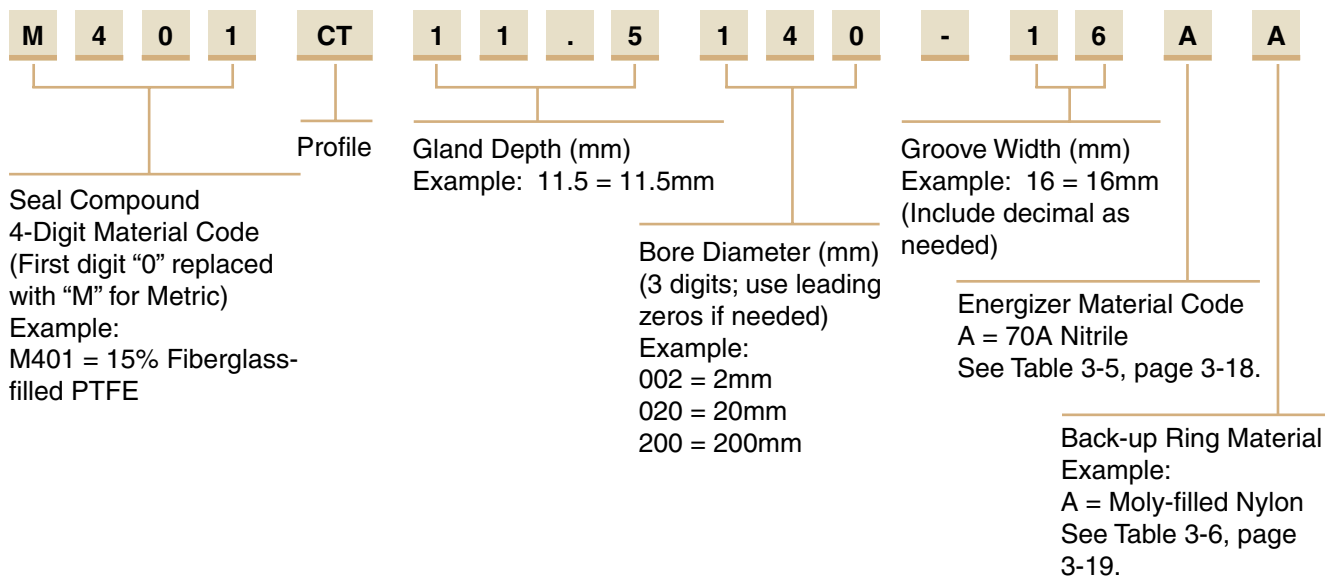

09/01/07



# Piston Seal CQ Profile

Catalog EPS 5370/USA

## CQ Profile, Premium PTFE Cap Seal with Anti-Drift Technology

The Parker CQ profile is a bi-directional piston seal for use in medium to heavy duty hydraulic applications. The CQ profile is a unique seal design that includes a rubber quad seal in the PTFE cap to ensure drift free performance. The PTFE cap is a stable rectangular shape and is energized, depending on its cross section, by a single square energizer or dual Parker o-rings. The CQ piston seal is commonly used in applications such as mobile hydraulics, lift trucks, standard cylinders and piston accumulators. Parker's CQ profile will retrofit non-Parker seals of similar design.

The CQ profile may be ordered without the energizer and quad seal by omitting the energizer/quad seal code. See part number nomenclature.

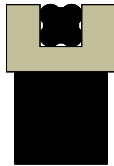

CQ Cross-Section  
Square Ring

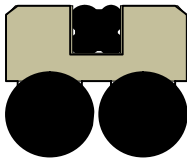

CQ Cross-Section  
dual O-ring



CQ installed in Piston Gland

### Technical Data

Standard Materials*	Temperature Range	Pressure Range†	Surface Speed
<b>Cap</b> 0401 40% bronze filled PTFE		5000 psi (344 bar)	< 9.8 ft/s (3 m/sec)
<b>Energizer/Quad Seal</b> A 70A Nitrile	-30°F to 250°F (-34°C to 121°C)		

\***Alternate Materials:** For applications that may require an alternate material, please see Section 3 for alternate PTFE (Table 3-4) and energizer (Table 3-5) materials.

†**Pressure Range** without wear rings (see Table 2-4, page 2-5).

### Options

**Notched Walls:** Adding an "N" to the end of the part number indicates that notches are to be added to the side walls of the PTFE cap. Notches can help optimize the seal's response to fluid pressure. In application, the void created by the notch allows fluid pressure to fill the cavity between the side face of the gland and the seal. Consult your local Parker Seal representative for the availability and cost to add side notches to the CQ profile.

N = Notched walls 

**Metric:** To configure metric part numbering, see Table 7-45 on page 7-52, and call your local Parker Seal representative for availability.

7

09/01/07

### Part Number Nomenclature — CQ Profile

Table 7-42. CQ Profile — Inch

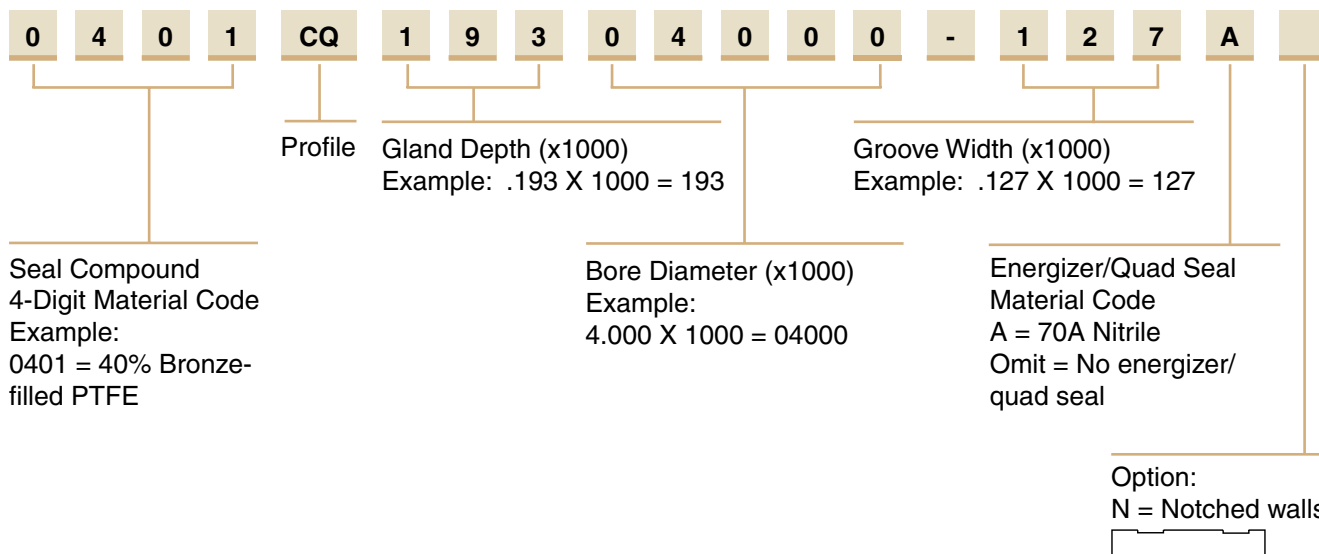

### Gland Dimension — CQ Profile — Square Ring

Please refer to Engineering Section 2, Page 2-8 for surface finish and additional hardware considerations.

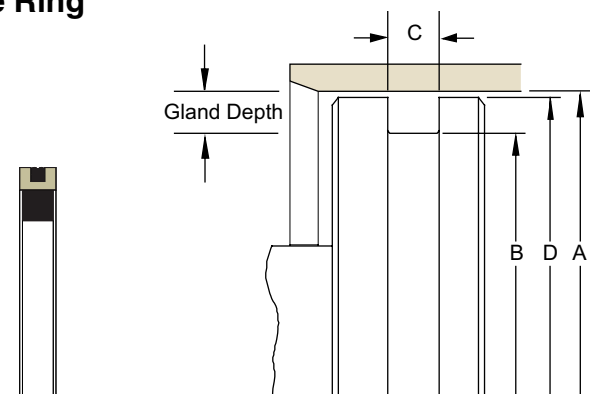

Table 7-43. CQ Gland Dimensions (Square Ring) — Inch

A Bore Diameter	B Groove Diameter	C Groove Width	D Piston Diameter*	Quad Seal Dash Number	Square Ring Number	Part Number (Square Ring)
+.002/-.000	+.000/-.003	+.005/-.000	+.000/-.002			
1.500	0.884	0.288	1.499	125	316	<b>0401CQ30801500-288A</b>
2.000	1.384	0.288	1.999	133	324	<b>0401CQ30802000-288A</b>
2.250	1.634	0.288	2.249	136	326	<b>0401CQ30802250-288A</b>
2.500	1.884	0.288	2.499	140	328	<b>0401CQ30802500-288A</b>
2.750	2.134	0.288	2.749	145	330	<b>0401CQ30802750-288A</b>
3.000	2.384	0.288	2.999	148	332	<b>0401CQ30803000-288A</b>
3.250	2.634	0.288	3.249	151	334	<b>0401CQ30803250-288A</b>
3.500	2.884	0.288	3.499	152	336	<b>0401CQ30803500-288A</b>
3.750	3.134	0.288	3.749	153	338	<b>0401CQ30803750-288A</b>
4.000	3.384	0.288	3.999	154	340	<b>0401CQ30804000-288A</b>
4.250	3.634	0.288	4.249	155	342	<b>0401CQ30804250-288A</b>
4.500	3.884	0.288	4.499	156	344	<b>0401CQ30804500-288A</b>
4.750	4.134	0.288	4.749	157	346	<b>0401CQ30804750-288A</b>

\*If used with wear rings, refer to wear ring piston diameter, see Section 9.

**Table 7-43. CQ Gland Dimensions (Square Ring) — Inch (Continued)**

A Bore Diameter	B Groove Diameter	C Groove Width	D Piston Diameter*	Quad Seal Dash Number	Square Ring Number	Part Number (Square Ring)
+0.004/-0.000	+0.000/-0.006	+0.005/-0.000	+0.000/-0.004			
5.000	4.384	0.288	4.998	158	348	0401CQ30805000-288A
5.250	4.542	0.288	5.248	159	350	0401CQ30805250-288A
5.500	4.660	0.375	5.498	160	426	0401CQ42005500-375A
5.750	4.910	0.375	5.748	161	428	0401CQ42005750-375A
6.000	5.160	0.375	5.998	162	430	0401CQ42006000-375A
6.500	5.660	0.375	6.498	164	434	0401CQ42006500-375A
7.000	6.160	0.375	6.998	166	437	0401CQ42007000-375A
7.500	6.660	0.375	7.498	168	439	0401CQ42007500-375A
8.000	7.160	0.375	7.998	170	441	0401CQ42008000-375A
9.000	8.160	0.375	8.998	174	445	0401CQ42009000-375A
10.000	9.160	0.375	9.998	178	447	0401CQ42010000-375A

\*If used with wear rings, refer to wear ring piston diameter, see Section 9.

NOTE: For sizes larger than those shown in the table, please contact your local Parker Seal representative.

**Gland Dimension — CQ Profile — Dual O-ring**

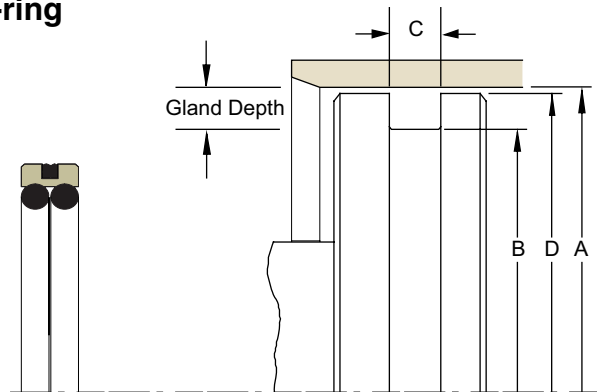

Please refer to Engineering Section 2, Page 2-8 for surface finish and additional hardware considerations.

**Table 7-44. CQ Gland Dimensions (Dual O-ring) — Inch**

A Bore Diameter	B Groove Diameter	C Groove Width	D Piston Diameter*	Quad Seal Dash Number	Dual O-ring Number	CQ Part Number (Dual O-ring)
+0.002/-0.000	+0.000/-0.003	+0.005/-0.000	+0.000/-0.002			
1.500	1.106	0.248	1.499	028	121	0401CQ19701500-248A
1.562	1.168	0.248	1.561	028	122	0401CQ19701562-248A
1.625	1.231	0.248	1.624	029	123	0401CQ19701625-248A
1.687	1.293	0.248	1.686	029	124	0401CQ19701687-248A
1.750	1.356	0.248	1.749	030	125	0401CQ19701750-248A
1.875	1.481	0.248	1.874	031	127	0401CQ19701875-248A
2.000	1.606	0.248	1.999	032	129	0401CQ19702000-248A
2.125	1.731	0.248	2.124	033	131	0401CQ19702125-248A
2.250	1.856	0.248	2.249	034	133	0401CQ19702250-248A
2.375	1.981	0.248	2.373	035	135	0401CQ19702375-248A
2.500	2.106	0.248	2.498	036	137	0401CQ19702500-248A
2.625	2.231	0.248	2.623	037	139	0401CQ19702625-248A
2.750	2.356	0.248	2.748	038	141	0401CQ19702750-248A
2.875	2.481	0.248	2.873	039	143	0401CQ19702875-248A
3.000	2.488	0.326	2.998	149	229	0401CQ25603000-326A

\*If used with wear rings, refer to wear ring piston diameter, see Section 9.

Table 7-44. CQ Gland Dimensions (Dual O-ring) — Inch (Continued)

A Bore Diameter	B Groove Diameter	C Groove Width	D Piston Diameter*	Quad Seal Dash Number	Dual O-ring Number	CQ Part Number (Dual O-ring)
<b>+0.002/-0.000</b>	<b>+0.000/-0.003</b>	<b>+0.005/-0.000</b>	<b>+0.000/-0.002</b>			
3.125	2.613	0.326	3.123	150	230	0401CQ25603125-326A
3.250	2.738	0.326	3.248	151	231	0401CQ25603250-326A
3.375	2.863	0.326	3.373	151	232	0401CQ25603375-326A
3.500	2.988	0.326	3.498	152	233	0401CQ25603500-326A
3.625	3.113	0.326	3.623	152	234	0401CQ25603625-326A
3.750	3.238	0.326	3.748	153	235	0401CQ25603750-326A
3.875	3.363	0.326	3.873	153	236	0401CQ25603875-326A
4.000	3.488	0.326	3.998	154	237	0401CQ25604000-326A
4.125	3.613	0.326	4.123	154	238	0401CQ25604125-326A
4.250	3.738	0.326	4.248	155	239	0401CQ25604250-326A
4.375	3.863	0.326	4.373	155	240	0401CQ25604375-326A
4.500	3.988	0.326	4.498	156	241	0401CQ25604500-326A
4.625	4.113	0.326	4.623	156	242	0401CQ25604625-326A
4.750	4.238	0.326	4.748	157	243	0401CQ25604750-326A
4.875	4.363	0.326	4.873	157	244	0401CQ25604875-326A
<b>+0.004/-0.000</b>	<b>+0.000/-0.006</b>	<b>+0.005/-0.000</b>	<b>+0.000/-0.004</b>			
5.000	4.292	0.484	4.998	248	346	0401CQ35405000-484A
5.125	4.417	0.484	5.123	249	347	0401CQ35405125-484A
5.250	4.542	0.484	5.248	250	348	0401CQ35405250-484A
5.375	4.667	0.484	5.373	251	349	0401CQ35405375-484A
5.500	4.792	0.484	5.498	252	350	0401CQ35405500-484A
5.625	4.917	0.484	5.623	253	351	0401CQ35405625-484A
5.750	5.042	0.484	5.748	254	352	0401CQ35405750-484A
5.875	5.167	0.484	5.873	255	353	0401CQ35405875-484A
6.000	5.292	0.484	5.998	256	354	0401CQ35406000-484A
6.250	5.542	0.484	6.248	258	356	0401CQ35406250-484A
6.500	5.792	0.484	6.498	259	358	0401CQ35406500-484A
6.750	6.042	0.484	6.748	260	360	0401CQ35406750-484A
7.000	6.292	0.484	6.998	261	361	0401CQ35407000-484A
7.250	6.542	0.484	7.248	262	362	0401CQ35407250-484A
7.500	6.792	0.484	7.498	263	363	0401CQ35407500-484A
7.750	7.042	0.484	7.748	264	364	0401CQ35407750-484A
8.000	7.292	0.484	7.998	265	365	0401CQ35408000-484A
8.250	7.542	0.484	8.248	266	366	0401CQ35408250-484A
8.500	7.792	0.484	8.498	267	367	0401CQ35408500-484A
8.750	8.042	0.484	8.748	268	368	0401CQ35408750-484A
9.000	8.292	0.484	8.998	269	369	0401CQ35409000-484A
9.250	8.542	0.484	9.248	270	370	0401CQ35409250-484A
9.500	8.792	0.484	9.498	271	371	0401CQ35409500-484A
9.750	9.042	0.484	9.748	272	372	0401CQ35409750-484A
10.000	9.292	0.484	9.998	273	373	0401CQ35410000-484A
10.500	9.792	0.484	10.498	274	375	0401CQ35410500-484A
11.000	10.292	0.484	10.998	275	377	0401CQ35411000-484A
11.500	10.792	0.484	11.498	276	378	0401CQ35411500-484A
<b>+0.006/-0.000</b>	<b>+0.000/-0.008</b>	<b>+0.005/-0.000</b>	<b>+0.000/-0.006</b>			
12.000	10.780	0.642	11.998	380	450	0401CQ61012000-642A
12.500	11.280	0.642	12.498	381	451	0401CQ61012500-642A
13.000	11.780	0.642	12.998	381	452	0401CQ61013000-642A
13.500	12.280	0.642	13.498	382	453	0401CQ61013500-642A
14.000	12.780	0.642	13.998	382	454	0401CQ61014000-642A

\*If used with wear rings, refer to wear ring piston diameter, see Section 9.

09/01/07

7

**CQ Profile**

**Table 7-44. CQ Gland Dimensions (Dual O-ring) — Inch (Continued)**

A Bore Diameter	B Groove Diameter	C Groove Width	D Piston Diameter*	Quad Seal Dash Number	Dual O-ring Number	CQ Part Number (Dual O-ring)
14.500	13.280	0.642	14.498	383	455	0401CQ61014500-642A
15.000	13.780	0.642	14.998	383	456	0401CQ61015000-642A
15.500	14.280	0.642	15.498	384	457	0401CQ61015500-642A
16.000	14.780	0.642	15.998	384	458	0401CQ61016000-642A
16.500	15.280	0.642	16.498	385	459	0401CQ61016500-642A
17.000	15.780	0.642	16.998	385	460	0401CQ61017000-642A
17.500	16.280	0.642	17.498	386	461	0401CQ61017500-642A
18.000	16.780	0.642	17.998	386	462	0401CQ61018000-642A
18.500	17.280	0.642	18.498	387	463	0401CQ61018500-642A
19.000	17.780	0.642	18.998	387	464	0401CQ61019000-642A
19.500	18.280	0.642	19.498	388	465	0401CQ61019500-642A
20.000	18.780	0.642	19.998	388	466	0401CQ61020000-642A

\*If used with wear rings, refer to wear ring piston diameter, see Section 9.

NOTE: For sizes larger than those shown in the table, please contact your local Parker Seal representative.

**Part Number Nomenclature — CQ Profile**

**Table 7-45. CQ Profile — Metric (mm)**

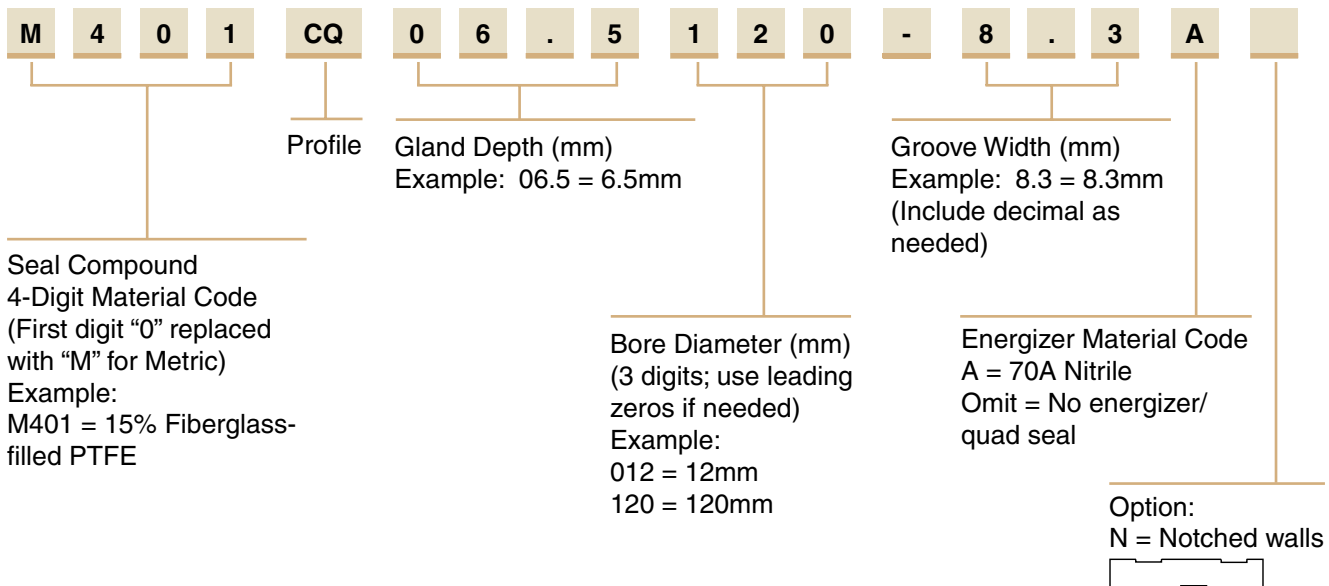

7



# Piston Seal OE Profile

Catalog EPS 5370/USA

## OE Profile, PTFE Piston Cap Seal



The Parker OE profile is a bi-directional piston seal for use in low to medium duty hydraulic applications. The OE profile is a two piece design comprised of a standard size Parker o-ring energizing a wear resistant PTFE cap. The OE profile offers long wear, low friction and because of its short assembly length requires minimal gland space on the piston. The seal is commonly used in applications such as mobile hydraulics, machine tools, injection molding machines and hydraulic presses. Parker's OE profile will retrofit non-Parker seals of similar design.

The OE profile may be ordered without the energizer by omitting the energizer code. See part number nomenclature.

### Technical Data

Standard Materials*	Temperature Range	Pressure Range†	Surface Speed
<b>Cap</b>			
0401 40% bronze filled PTFE	-200°F to 575°F (-129°C to 302°C)	5000 psi (344 bar)	< 13 ft/s (4 m/sec)
<b>Energizer</b>			
A 70A Nitrile	-30°F to 250°F (-34°C to 121°C)		

**\*Alternate Materials:** For applications that may require an alternate material, please see Section 3 for alternate PTFE (Table 3-4) and energizer (Table 3-5) materials.

**†Pressure Range** without wear rings (see Table 2-4, page 2-5).

### Options

**Notched side walls:** Adding an "N" to the end of the part number indicates that notches are to be added to the side walls of the PTFE cap. Notches can help optimize the seal's response to fluid pressure.

In application, the void created by the notch allows fluid pressure to fill the cavity between the side face of the gland and the seal. Consult your local Parker Seal representative for the availability and cost to add side notches to the OE profile.

N = Notched walls 

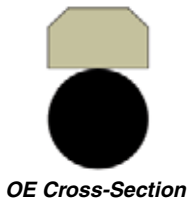

OE Cross-Section

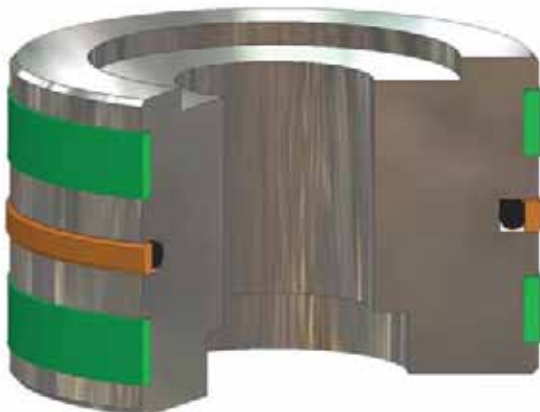

OE installed in Piston Gland



**OE Profile**

**Part Number Nomenclature — OE Profile**

Table 7-46. OE Profile — Inch

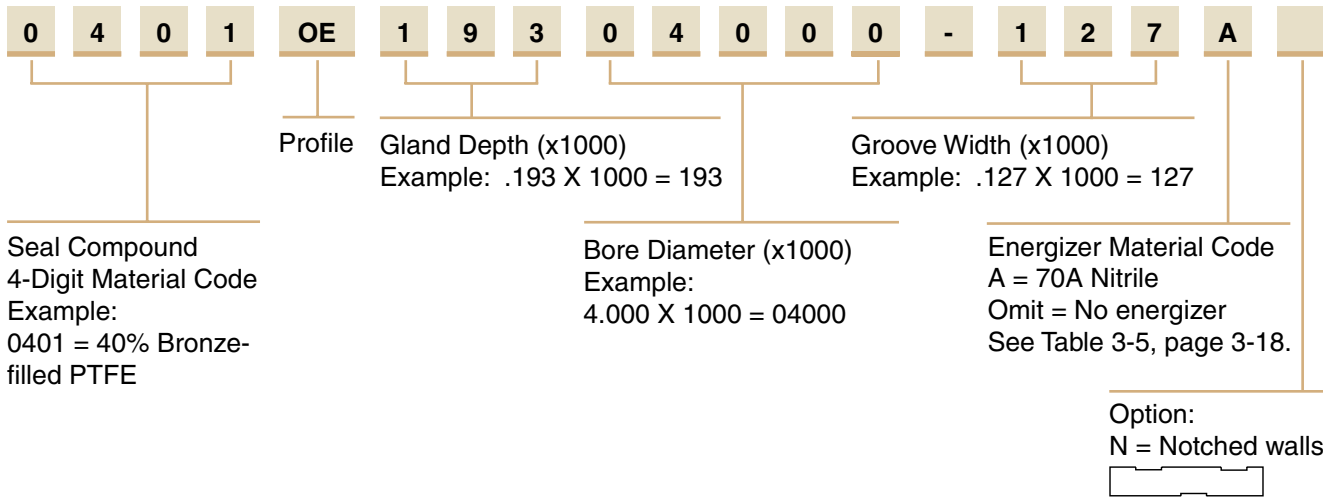

**Gland Dimension — OE Profile**

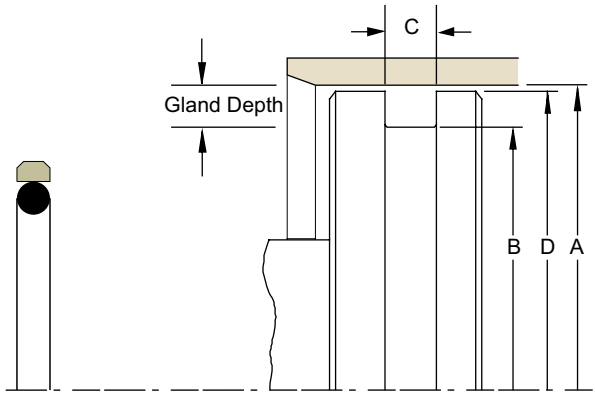

Please refer to Engineering Section 2, Page 2-8 for surface finish and additional hardware considerations.

Table 7-47. OE Gland Dimensions — Inch

A Bore Diameter	B Groove Diameter	C Groove Width	D Piston Diameter*	O-ring Dash Number	Part Number
+.001/-.000	+.000/-.001	+.005/-.000	.000/-.002		
0.500	0.326	0.081	0.499	011	0401OE08700500-081A
0.562	0.388	0.081	0.561	012	0401OE08700562-081A
0.625	0.451	0.081	0.624	013	0401OE08700625-081A
0.687	0.513	0.081	0.686	014	0401OE08700687-081A
0.750	0.576	0.081	0.749	015	0401OE08700750-081A
0.812	0.638	0.081	0.811	016	0401OE08700812-081A
0.875	0.701	0.081	0.874	017	0401OE08700875-081A
0.937	0.763	0.081	0.936	018	0401OE08700937-081A
1.000	0.826	0.081	0.999	019	0401OE08701000-081A
1.062	0.888	0.081	1.061	020	0401OE08701062-081A
1.125	0.951	0.081	1.124	021	0401OE08701125-081A
1.187	1.013	0.081	1.186	022	0401OE08701187-081A
1.250	1.076	0.081	1.249	023	0401OE08701250-081A
1.312	1.138	0.081	1.311	024	0401OE08701312-081A
1.375	1.201	0.081	1.374	025	0401OE08701375-081A
1.437	1.263	0.081	1.436	026	0401OE08701437-081A
1.500	1.326	0.081	1.499	027	0401OE08701500-081A

\*If used with wear rings, refer to wear ring piston diameter, see Section 9.



Table 7-47. OE Gland Dimensions — Inch (Continued)

A Bore Diameter	B Groove Diameter	C Groove Width	D Piston Diameter*	O-ring Dash Number	Part Number
<b>+.002/-0.000</b>	<b>+.000/-0.002</b>	<b>+.005/-0.000</b>	<b>+.000/-0.002</b>		
0.500	0.244	0.081	0.499	010	0401OE12800500-081A
0.562	0.306	0.081	0.561	011	0401OE12800562-081A
0.625	0.369	0.081	0.624	012	0401OE12800625-081A
0.687	0.431	0.081	0.686	013	0401OE12800687-081A
0.750	0.494	0.081	0.749	014	0401OE12800750-081A
0.812	0.556	0.081	0.811	015	0401OE12800812-081A
0.875	0.619	0.081	0.874	016	0401OE12800875-081A
0.937	0.681	0.081	0.936	017	0401OE12800937-081A
1.000	0.744	0.081	0.999	018	0401OE12801000-081A
1.062	0.806	0.081	1.061	019	0401OE12801062-081A
1.125	0.869	0.081	1.124	020	0401OE12801125-081A
1.187	0.931	0.081	1.186	021	0401OE12801187-081A
1.250	0.994	0.081	1.249	022	0401OE12801250-081A
1.312	1.056	0.081	1.311	023	0401OE12801312-081A
1.375	1.119	0.081	1.374	024	0401OE12801375-081A
1.437	1.181	0.081	1.436	025	0401OE12801437-081A
1.500	1.244	0.081	1.499	026	0401OE12801500-081A
<b>+.002/-0.000</b>	<b>+.000/-0.003</b>	<b>+.005/-0.000</b>	<b>+.000/-0.002</b>		
0.750	0.452	0.126	0.749	111	0401OE14900750-126A
0.812	0.514	0.126	0.811	112	0401OE14900812-126A
0.875	0.577	0.126	0.874	113	0401OE14900875-126A
0.937	0.639	0.126	0.936	114	0401OE14900937-126A
1.000	0.702	0.126	0.999	115	0401OE14901000-126A
1.062	0.764	0.126	1.061	116	0401OE14901062-126A
1.125	0.827	0.126	1.124	117	0401OE14901125-126A
1.187	0.889	0.126	1.186	118	0401OE14901187-126A
1.250	0.952	0.126	1.249	119	0401OE14901250-126A
1.312	1.014	0.126	1.311	120	0401OE14901312-126A
1.375	1.077	0.126	1.374	121	0401OE14901375-126A
1.437	1.139	0.126	1.436	122	0401OE14901437-126A
1.500	1.202	0.126	1.499	123	0401OE14901500-126A
1.562	1.264	0.126	1.561	124	0401OE14901562-126A
1.625	1.327	0.126	1.624	125	0401OE14901625-126A
1.687	1.389	0.126	1.686	126	0401OE14901687-126A
1.750	1.452	0.126	1.749	127	0401OE14901750-126A
1.875	1.577	0.126	1.874	129	0401OE14901875-126A
2.000	1.702	0.126	1.999	131	0401OE14902000-126A
2.125	1.827	0.126	2.124	133	0401OE14902125-126A
2.250	1.952	0.126	2.249	135	0401OE14902250-126A
2.375	2.077	0.126	2.374	137	0401OE14902375-126A
2.500	2.202	0.126	2.499	139	0401OE14902500-126A
2.625	2.327	0.126	2.624	141	0401OE14902625-126A
2.750	2.452	0.126	2.749	143	0401OE14902750-126A
1.562	1.176	0.120	1.561	123	0401OE19301562-120A
1.625	1.239	0.120	1.624	124	0401OE19301625-120A
1.687	1.301	0.120	1.686	125	0401OE19301687-120A
1.750	1.364	0.120	1.749	126	0401OE19301750-120A
1.875	1.489	0.120	1.874	128	0401OE19301875-120A
2.000	1.614	0.127	1.999	130	0401OE19302000-127A
2.125	1.739	0.127	2.124	132	0401OE19302125-127A
2.250	1.864	0.127	2.249	134	0401OE19302250-127A

\*If used with wear rings, refer to wear ring piston diameter, see Section 9.

09/01/07



Table 7-47. OE Gland Dimensions — Inch (Continued)

A Bore Diameter	B Groove Diameter	C Groove Width	D Piston Diameter*	O-ring Dash Number	Part Number
<b>+ .002/- .000</b>	<b>+ .000/- .003</b>	<b>+ .005/- .000</b>	<b>+ .000/- .002</b>		
2.375	1.989	0.127	2.374	136	0401OE19302375-127A
2.500	2.114	0.127	2.499	138	0401OE19302500-127A
2.625	2.239	0.127	2.624	140	0401OE19302625-127A
2.750	2.364	0.127	2.749	142	0401OE19302750-127A
2.875	2.489	0.127	2.874	144	0401OE19302875-127A
3.000	2.614	0.127	2.999	146	0401OE19303000-127A
3.125	2.739	0.127	3.124	148	0401OE19303125-127A
3.250	2.864	0.127	3.249	150	0401OE19303250-127A
3.375	2.989	0.127	3.374	151	0401OE19303375-127A
3.500	3.114	0.127	3.499	151	0401OE19303500-127A
3.625	3.239	0.127	3.624	152	0401OE19303625-127A
3.750	3.364	0.127	3.749	152	0401OE19303750-127A
3.875	3.489	0.127	3.874	153	0401OE19303875-127A
4.000	3.614	0.127	3.999	153	0401OE19304000-127A
4.125	3.739	0.127	4.124	154	0401OE19304125-127A
4.250	3.864	0.127	4.249	154	0401OE19304250-127A
4.375	3.989	0.127	4.374	155	0401OE19304375-127A
4.500	4.114	0.127	4.499	155	0401OE19304500-127A
4.625	4.239	0.127	4.624	156	0401OE19304625-127A
4.750	4.364	0.127	4.749	156	0401OE19304750-127A
4.875	4.489	0.127	4.874	157	0401OE19304875-127A
5.000	4.614	0.127	4.999	157	0401OE19305000-127A
5.125	4.739	0.127	5.124	158	0401OE19305125-127A
5.250	4.864	0.127	5.249	158	0401OE19305250-127A
5.375	4.989	0.127	5.374	159	0401OE19305375-127A
5.500	5.114	0.127	5.499	159	0401OE19305500-127A
<b>+ .003/- .000</b>	<b>+ .000/- .004</b>	<b>+ .005/- .000</b>	<b>+ .000/- .003</b>		
1.562	1.138	0.166	1.561	217	0401OE21201562-166A
1.625	1.201	0.166	1.624	218	0401OE21201625-166A
1.687	1.263	0.166	1.686	219	0401OE21201687-166A
1.750	1.326	0.166	1.749	221	0401OE21201750-166A
1.875	1.451	0.166	1.874	222	0401OE21201875-166A
2.000	1.576	0.166	1.999	223	0401OE21202000-166A
2.125	1.701	0.166	2.124	224	0401OE21202125-166A
2.250	1.826	0.166	2.249	225	0401OE21202250-166A
2.375	1.951	0.166	2.374	226	0401OE21202375-166A
2.500	2.076	0.166	2.499	227	0401OE21202500-166A
2.625	2.201	0.166	2.624	228	0401OE21202625-166A
2.750	2.326	0.166	2.749	229	0401OE21202750-166A
2.875	2.451	0.166	2.874	230	0401OE21202875-166A
3.000	2.576	0.166	2.999	231	0401OE21203000-166A
3.125	2.701	0.166	3.124	232	0401OE21203125-166A
3.250	2.826	0.166	3.249	233	0401OE21203250-166A
3.375	2.951	0.166	3.374	234	0401OE21203375-166A
3.500	3.076	0.166	3.499	235	0401OE21203500-166A
3.625	3.201	0.166	3.624	236	0401OE21203625-166A
3.750	3.326	0.166	3.749	237	0401OE21203750-166A
3.875	3.451	0.166	3.874	238	0401OE21203875-166A
4.000	3.576	0.166	3.999	239	0401OE21204000-166A

\*If used with wear rings, refer to wear ring piston diameter, see Section 9.

09/01/07

Table 7-47. OE Gland Dimensions — Inch (Continued)

A Bore Diameter	B Groove Diameter	C Groove Width	D Piston Diameter*	O-ring Dash Number	Part Number
<b>+0.003/-0.000</b>	<b>+0.000/-0.004</b>	<b>+0.005/-0.000</b>	<b>+0.000/-0.003</b>		
4.125	3.701	0.166	4.124	240	0401OE21204125-166A
4.250	3.826	0.166	4.249	241	0401OE21204250-166A
4.375	3.951	0.166	4.374	242	0401OE21204375-166A
4.500	4.076	0.166	4.499	243	0401OE21204500-166A
4.625	4.201	0.166	4.624	244	0401OE21204625-166A
4.750	4.326	0.166	4.749	245	0401OE21204750-166A
4.875	4.451	0.166	4.874	246	0401OE21204875-166A
5.000	4.576	0.166	4.999	247	0401OE21205000-166A
5.125	4.701	0.166	5.124	248	0401OE21205125-166A
5.250	4.826	0.166	5.249	249	0401OE21205250-166A
5.375	4.951	0.166	5.374	250	0401OE21205375-166A
5.500	5.076	0.166	5.499	251	0401OE21205500-166A
<b>+0.003/-0.000</b>	<b>+0.000/-0.005</b>	<b>+0.005/-0.000</b>	<b>+0.000/-0.003</b>		
5.625	5.109	0.157	5.623	251	0401OE25805625-157A
5.750	5.234	0.157	5.748	252	0401OE25805750-157A
5.875	5.359	0.157	5.873	253	0401OE25805875-157A
6.000	5.484	0.157	5.998	254	0401OE25806000-157A
6.125	5.609	0.157	6.123	255	0401OE25806125-157A
6.250	5.734	0.157	6.248	256	0401OE25806250-157A
6.375	5.859	0.157	6.373	257	0401OE25806375-157A
6.500	5.984	0.157	6.498	258	0401OE25806500-157A
6.750	6.234	0.157	6.748	259	0401OE25806750-157A
7.000	6.484	0.157	6.998	260	0401OE25807000-157A
7.250	6.734	0.157	7.248	261	0401OE25807250-157A
7.500	6.984	0.157	7.498	262	0401OE25807500-157A
7.750	7.234	0.157	7.748	263	0401OE25807750-157A
8.000	7.484	0.157	7.998	264	0401OE25808000-157A
8.250	7.734	0.157	8.248	265	0401OE25808250-157A
8.500	7.984	0.157	8.498	266	0401OE25808500-157A
9.000	8.484	0.157	8.998	268	0401OE25809000-157A
9.500	8.984	0.157	9.498	270	0401OE25809500-157A
10.000	9.484	0.157	9.998	272	0401OE25810000-157A
10.500	9.984	0.157	10.498	274	0401OE25810500-157A
11.000	10.484	0.157	10.998	275	0401OE25811000-157A
11.500	10.984	0.157	11.498	276	0401OE25811500-157A
12.000	11.484	0.157	11.998	277	0401OE25812000-157A
<b>+0.003/-0.000</b>	<b>+0.000/-0.006</b>	<b>+0.005/-0.000</b>	<b>+0.000/-0.003</b>		
3.125	2.509	0.247	3.123	333	0401OE30803125-247A
3.250	2.634	0.247	3.248	334	0401OE30803250-247A
3.375	2.759	0.247	3.373	335	0401OE30803375-247A
3.500	2.884	0.247	3.498	336	0401OE30803500-247A
3.625	3.009	0.247	3.623	337	0401OE30803625-247A
3.750	3.134	0.247	3.748	338	0401OE30803750-247A
3.875	3.259	0.247	3.873	339	0401OE30803875-247A
4.000	3.384	0.247	3.998	340	0401OE30804000-247A
4.125	3.509	0.247	4.123	341	0401OE30804125-247A
4.250	3.634	0.247	4.248	342	0401OE30804250-247A
4.375	3.759	0.247	4.373	343	0401OE30804375-247A
4.500	3.884	0.247	4.498	344	0401OE30804500-247A

\*If used with wear rings, refer to wear ring piston diameter, see Section 9.

7

Table 7-47. OE Gland Dimensions — Inch (Continued)

A Bore Diameter	B Groove Diameter	C Groove Width	D Piston Diameter*	O-ring Dash Number	Part Number
<b>+.003/-.000</b>	<b>+.000/-.006</b>	<b>+.005/-.000</b>	<b>+.000/-.003</b>		
4.625	4.009	0.247	4.623	345	0401OE30804625-247A
4.750	4.134	0.247	4.748	346	0401OE30804750-247A
4.875	4.259	0.247	4.873	347	0401OE30804875-247A
5.000	4.384	0.247	4.998	348	0401OE30805000-247A
5.125	4.509	0.247	5.123	349	0401OE30805125-247A
5.250	4.634	0.247	5.248	350	0401OE30805250-247A
5.375	4.759	0.247	5.373	351	0401OE30805375-247A
5.500	4.884	0.247	5.498	352	0401OE30805500-247A
5.625	5.009	0.247	5.623	353	0401OE30805625-247A
5.750	5.134	0.247	5.748	354	0401OE30805750-247A
5.875	5.259	0.247	5.873	355	0401OE30805875-247A
6.000	5.384	0.247	5.998	356	0401OE30806000-247A
6.125	5.509	0.247	6.123	357	0401OE30806125-247A
6.250	5.634	0.247	6.248	358	0401OE30806250-247A
6.375	5.759	0.247	6.373	359	0401OE30806375-247A
6.500	5.884	0.247	6.498	360	0401OE30806500-247A
6.750	6.134	0.247	6.748	361	0401OE30806750-247A
7.000	6.384	0.247	6.998	362	0401OE30807000-247A
7.250	6.634	0.247	7.248	363	0401OE30807250-247A
7.500	6.884	0.247	7.498	364	0401OE30807500-247A
7.750	7.134	0.247	7.748	365	0401OE30807750-247A
8.000	7.384	0.247	7.998	366	0401OE30808000-247A
8.250	7.634	0.247	8.248	367	0401OE30808250-247A
8.500	7.884	0.247	8.498	368	0401OE30808500-247A
9.000	8.384	0.247	8.998	370	0401OE30809000-247A
9.500	8.884	0.247	9.498	372	0401OE30809500-247A
10.000	9.384	0.247	9.998	374	0401OE30810000-247A
10.500	9.884	0.247	10.498	376	0401OE30810500-247A
11.000	10.384	0.247	10.998	377	0401OE30811000-247A
11.500	10.884	0.247	11.498	378	0401OE30811500-247A
12.000	11.384	0.247	11.998	379	0401OE30812000-247A
<b>+.004/-.000</b>	<b>+.000/-.007</b>	<b>+.005/-.000</b>	<b>+.000/-.004</b>		
5.375	4.545	0.320	5.373	425	0401OE41505375-320A
5.500	4.670	0.320	5.498	426	0401OE41505500-320A
5.625	4.795	0.320	5.623	427	0401OE41505625-320A
5.750	4.920	0.320	5.748	428	0401OE41505750-320A
5.875	5.045	0.320	5.873	429	0401OE41505875-320A
6.000	5.170	0.320	5.998	430	0401OE41506000-320A
6.125	5.295	0.320	6.123	431	0401OE41506125-320A
6.250	5.420	0.320	6.248	432	0401OE41506250-320A
6.375	5.545	0.320	6.373	433	0401OE41506375-320A
6.500	5.670	0.320	6.498	435	0401OE41506500-320A
6.750	5.920	0.320	6.748	436	0401OE41506750-320A
7.000	6.170	0.320	6.998	437	0401OE41507000-320A
7.250	6.420	0.320	7.248	438	0401OE41507250-320A
7.500	6.670	0.320	7.498	439	0401OE41507500-320A
7.750	6.920	0.320	7.748	440	0401OE41507750-320A
8.000	7.170	0.320	7.998	441	0401OE41508000-320A
8.250	7.420	0.320	8.248	442	0401OE41508250-320A

\*If used with wear rings, refer to wear ring piston diameter, see Section 9.

09/01/07



**Table 7-47. OE Gland Dimensions — Inch (Continued)**

A Bore Diameter	B Groove Diameter	C Groove Width	D Piston Diameter*	O-ring Dash Number	Part Number
8.500	7.670	0.320	8.498	443	0401OE41508500-320A
9.000	8.170	0.320	8.998	445	0401OE41509000-320A
9.500	8.670	0.320	9.498	446	0401OE41509500-320A
10.000	9.170	0.320	9.998	447	0401OE41510000-320A
10.500	9.670	0.320	10.498	448	0401OE41510500-320A
11.000	10.170	0.320	10.998	449	0401OE41511000-320A
11.500	10.670	0.320	11.498	450	0401OE41511500-320A
12.000	11.170	0.320	11.998	451	0401OE41512000-320A
12.500	11.670	0.320	12.498	452	0401OE41512500-320A
13.000	12.170	0.320	12.998	453	0401OE41513000-320A
13.500	12.670	0.320	13.498	454	0401OE41513500-320A
14.000	13.170	0.320	13.998	455	0401OE41514000-320A
14.500	13.670	0.320	14.498	456	0401OE41514500-320A
15.000	14.170	0.320	14.998	457	0401OE41515000-320A
15.500	14.670	0.320	15.498	458	0401OE41515500-320A
16.000	15.170	0.320	15.998	459	0401OE41516000-320A

\*If used with wear rings, refer to wear ring piston diameter, see Section 9.

NOTE: For sizes larger than those shown in the table, please contact your local Parker Seal representative.

**Part Number Nomenclature — OE Profile**

**Table 7-48. OE Profile — Metric (mm)**

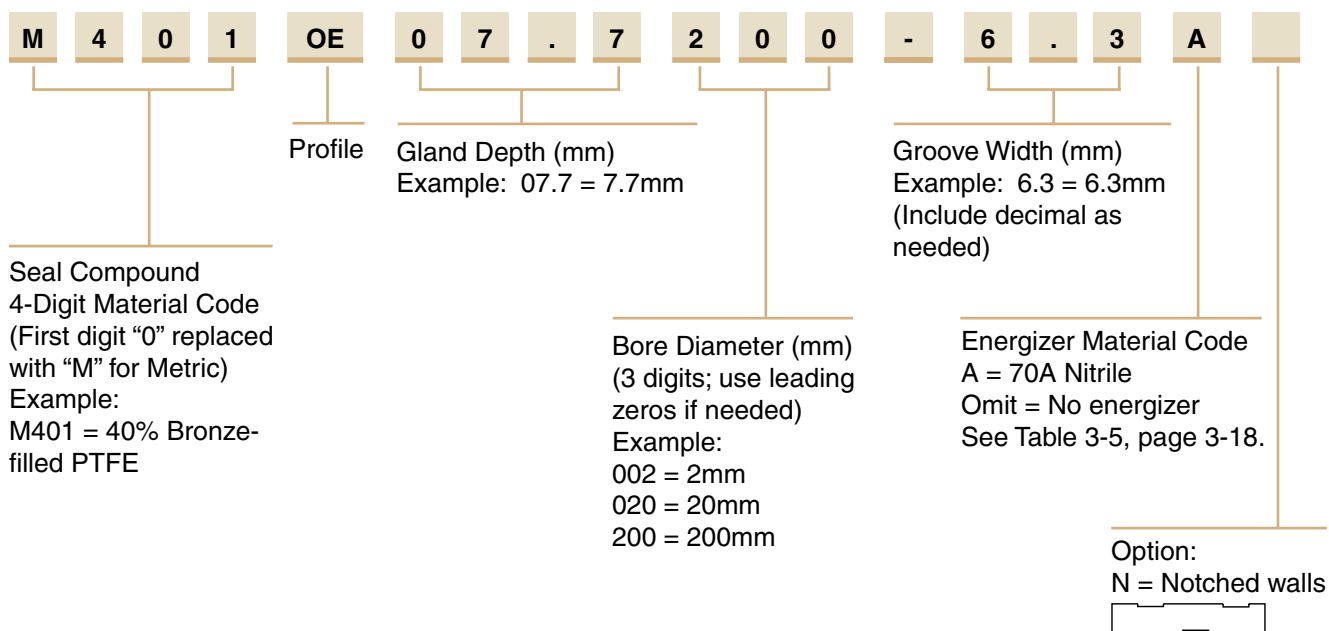

**OE Profile**

**Gland Dimension — OE Profile**

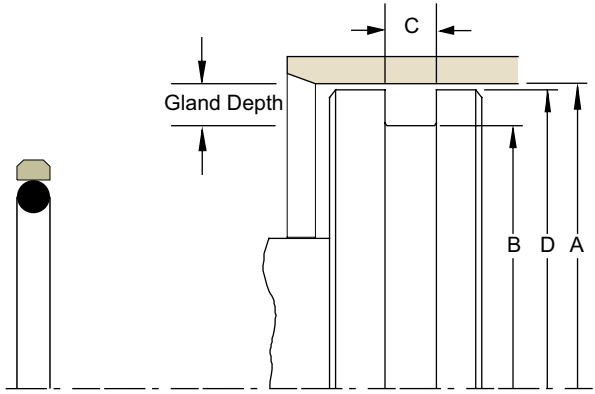

Please refer to Engineering Section 2, Page 2-8 for surface finish and additional hardware considerations.

**Table 7-49. OE Gland Dimensions — Metric (mm)**

A Bore Diameter	B Groove Diameter	C Groove Width	D Piston Diameter*	O-ring Dash Number	Part Number
H9	h9	+0.02/-0.00	h8		
8.00	3.00	2.20	7.97	005	M401OE02.5008-2.2A
10.00	5.00	2.20	9.97	010	M401OE02.5010-2.2A
11.00	6.00	2.20	10.97	010	M401OE02.5011-2.2A
12.00	7.00	2.20	11.97	010	M401OE02.5012-2.2A
13.00	8.00	2.20	12.97	011	M401OE02.5013-2.2A
14.00	9.00	2.20	13.97	011	M401OE02.5014-2.2A
16.00	8.50	3.20	15.94	109	M401OE03.7016-3.2A
18.00	10.50	3.20	17.94	110	M401OE03.7018-3.2A
20.00	12.50	3.20	19.94	112	M401OE03.7020-3.2A
22.00	14.50	3.20	21.94	113	M401OE03.7022-3.2A
24.00	16.50	3.20	23.94	114	M401OE03.7024-3.2A
25.00	17.50	3.20	24.94	115	M401OE03.7025-3.2A
28.00	20.50	3.20	27.94	117	M401OE03.7028-3.2A
30.00	22.50	3.20	29.94	118	M401OE03.7030-3.2A
32.00	24.50	3.20	31.94	119	M401OE03.7032-3.2A
35.00	27.50	3.20	34.94	121	M401OE03.7035-3.2A
36.00	28.50	3.20	35.94	122	M401OE03.7036-3.2A
38.00	30.50	3.20	37.94	123	M401OE03.7038-3.2A
40.00	32.50	3.20	39.94	124	M401OE03.7040-3.2A
25.00	14.00	4.20	24.94	207	M401OE05.5025-4.2A
32.00	21.00	4.20	31.94	211	M401OE05.5032-4.2A
40.00	29.00	4.20	39.94	216	M401OE05.5040-4.2A
45.00	34.00	4.20	44.94	219	M401OE05.5045-4.2A
50.00	39.00	4.20	49.94	222	M401OE05.5050-4.2A
55.00	44.00	4.20	54.94	224	M401OE05.5055-4.2A
60.00	49.00	4.20	59.94	225	M401OE05.5060-4.2A
63.00	52.00	4.20	62.94	226	M401OE05.5063-4.2A
65.00	54.00	4.20	64.94	227	M401OE05.5065-4.2A
70.00	59.00	4.20	69.94	228	M401OE05.5070-4.2A
75.00	64.00	4.20	74.94	230	M401OE05.5075-4.2A
80.00	69.00	4.20	79.94	231	M401OE05.5080-4.2A
100.00	89.00	4.20	99.94	238	M401OE05.5100-4.2A
50.00	34.50	6.30	49.90	324	M401OE07.7050-6.3A
63.00	47.50	6.30	62.90	328	M401OE07.7063-6.3A
70.00	54.50	6.30	69.90	330	M401OE07.7070-6.3A
80.00	64.50	6.30	79.90	333	M401OE07.7080-6.3A
85.00	69.50	6.30	84.90	335	M401OE07.7085-6.3A
90.00	74.50	6.30	89.90	336	M401OE07.7090-6.3A
95.00	79.50	6.30	94.90	338	M401OE07.7095-6.3A
100.00	84.50	6.30	99.90	339	M401OE07.7100-6.3A

\*If used with wear rings, refer to wear ring piston diameter, see Section 9.

Table 7-49. OE Gland Dimensions — Metric (Continued)

A Bore Diameter	B Groove Diameter	C Groove Width	D Piston Diameter*	O-ring Dash Number	Part Number
H9	h9	+ .02/- .00	h8		
105.00	89.50	6.30	104.90	341	M401OE07.7105-6.3A
110.00	94.50	6.30	109.90	342	M401OE07.7110-6.3A
115.00	99.50	6.30	114.90	344	M401OE07.7115-6.3A
120.00	104.50	6.30	119.90	345	M401OE07.7120-6.3A
125.00	109.50	6.30	124.90	347	M401OE07.7125-6.3A
130.00	114.50	6.30	129.90	349	M401OE07.7130-6.3A
132.00	116.50	6.30	131.90	349	M401OE07.7132-6.3A
135.00	119.50	6.30	134.90	350	M401OE07.7135-6.3A
140.00	124.50	6.30	139.90	352	M401OE07.7140-6.3A
145.00	129.50	6.30	144.90	353	M401OE07.7145-6.3A
160.00	144.50	6.30	159.90	358	M401OE07.7160-6.3A
200.00	184.50	6.30	199.90	366	M401OE07.7200-6.3A
135.00	114.00	8.10	134.90	425	M401OE10.5135-8.1A
140.00	119.00	8.10	139.90	426	M401OE10.5140-8.1A
145.00	124.00	8.10	144.90	428	M401OE10.5145-8.1A
150.00	129.00	8.10	149.90	430	M401OE10.5150-8.1A
155.00	134.00	8.10	154.90	431	M401OE10.5155-8.1A
160.00	139.00	8.10	159.90	433	M401OE10.5160-8.1A
165.00	144.00	8.10	164.90	434	M401OE10.5165-8.1A
170.00	149.00	8.10	169.90	435	M401OE10.5170-8.1A
175.00	154.00	8.10	174.90	437	M401OE10.5175-8.1A
180.00	159.00	8.10	179.90	438	M401OE10.5180-8.1A
185.00	164.00	8.10	184.90	438	M401OE10.5185-8.1A
190.00	169.00	8.10	189.90	439	M401OE10.5190-8.1A
195.00	174.00	8.10	194.90	440	M401OE10.5195-8.1A
200.00	179.00	8.10	199.90	441	M401OE10.5200-8.1A
205.00	184.00	8.10	204.90	442	M401OE10.5205-8.1A
210.00	189.00	8.10	209.90	443	M401OE10.5210-8.1A
215.00	194.00	8.10	214.90	443	M401OE10.5215-8.1A
220.00	199.00	8.10	219.90	444	M401OE10.5220-8.1A
225.00	204.00	8.10	224.90	445	M401OE10.5225-8.1A
230.00	209.00	8.10	229.90	445	M401OE10.5230-8.1A
235.00	214.00	8.10	234.90	445	M401OE10.5235-8.1A
240.00	219.00	8.10	239.90	446	M401OE10.5240-8.1A
245.00	224.00	8.10	244.90	446	M401OE10.5245-8.1A
250.00	229.00	8.10	249.90	447	M401OE10.5250-8.1A

\*If used with wear rings, refer to wear ring piston diameter, see Section 9.

NOTE: For sizes larger than those shown in the table, please contact your local Parker Seal representative.



# Piston Seal CP Profile

Catalog EPS 5370/USA



## CP Profile, PTFE Piston Cap Seal

The Parker CP profile is a cap seal with anti-extrusion, low friction and low wear features. The CP profile is a bi-directional piston seal for use in low to medium duty applications. The CP profile retrofits into a standard size o-ring groove without modification. There are three CP profiles to match the groove width for a single o-ring, o-ring with one back-up, or an o-ring with two back-up rings. Because of the unique design of the filled PTFE cap, the CP profile offers long wear, low friction and anti-extrusion. Because of its short assembly length, only minimal gland space is needed to fit the seal on the piston. Parker's CP profile will retrofit non-Parker seals of similar design.

- CP0 — a standard o-ring groove.
- CP1 — an o-ring groove designed for one back-up ring.
- CP2 — an o-ring groove designed for two back-up rings.

The CP profile may be ordered without the energizer by omitting the energizer code. See part number nomenclature.

### Technical Data

Standard Materials*	Temperature Range	Pressure Range†	Surface Speed
<b>Cap</b>			
0401 40% bronze filled PTFE	-200°F to 575°F (-129°C to 302°C)	3,500 psi (240 bar)	< 13 ft/s (4 m/sec)
<b>Energizer</b>			
A 70A Nitrile	-30°F to 250°F (-34°C to 121°C)		

\***Alternate Materials:** For applications that may require an alternate material, please see Section 3 for alternate PTFE (Table 3-4) and energizer (Table 3-5) materials.

†**Pressure Range** without wear rings (see Table 2-4, page 2-5).



CP Cross-Section

### Options

**Notched side walls:** Adding an "N" to the end of the part number indicates that notches are to be added to the side walls of the PTFE cap. Notches can help optimize the seal's response to fluid pressure. In application, the void created by the notch allows fluid pressure to fill the cavity between the side face of the gland and the seal. Consult your local Parker Seal representative for the availability and cost to add side notches to the CP profile.

N = Notched walls 



CP installed in Piston Gland

09/01/07

### Part Number Nomenclature — CP Profile

Table 7-50. CP Profile — Inch

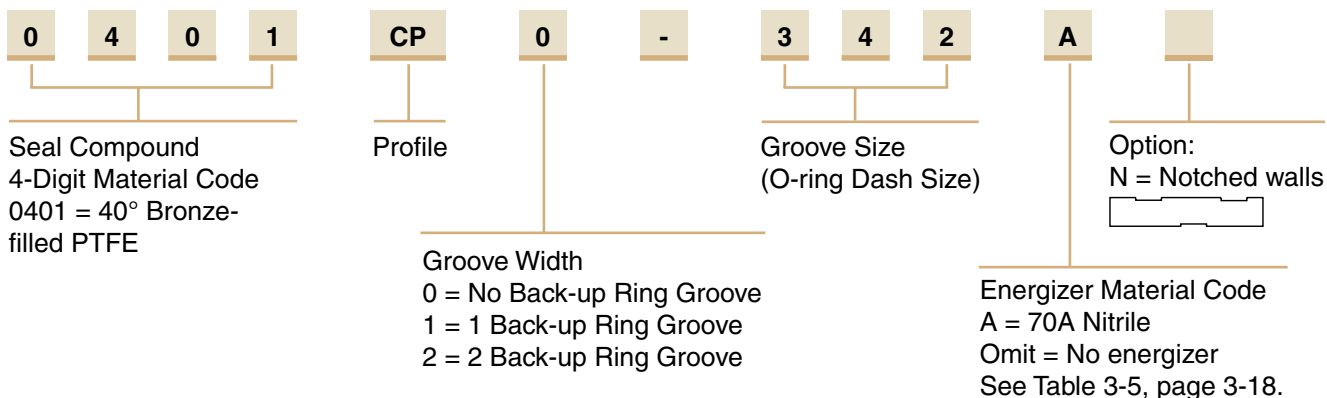

### Gland Dimension — CP Profile

Please refer to Engineering Section 2, Page 2-8 for surface finish and additional hardware considerations.

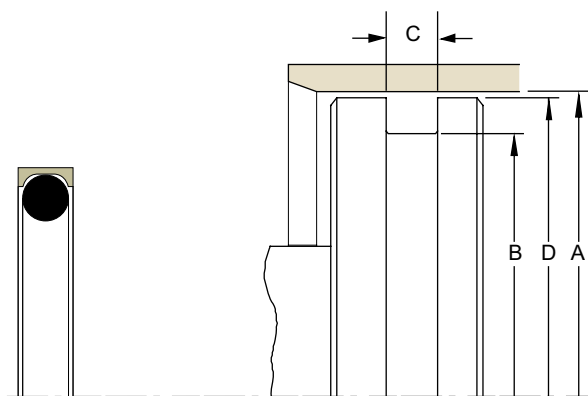

Table 7-51. CP Gland Dimensions — Inch

A Bore Diameter	B Groove Diameter	C Groove Width (CP0)	C Groove Width (CP1)	C Groove Width (CP2)	D Piston Diameter* 5000 psi (345 bar)	O-ring Dash Number	CP Part Number (X = Groove Width of 0, 1 or 2)
+0.002/-0.000	+0.000/-0.002	+0.005/-0.000	+0.005/-0.000	+0.005/-0.000	+0.000/-0.001		
0.250	0.140	0.093	0.138	0.205	0.249	006	0401CPX-006A
0.281	0.171	0.093	0.138	0.205	0.280	007	0401CPX-007A
0.312	0.202	0.093	0.138	0.205	0.311	008	0401CPX-008A
0.344	0.234	0.093	0.138	0.205	0.343	009	0401CPX-009A
0.375	0.265	0.093	0.138	0.205	0.374	010	0401CPX-010A
0.437	0.327	0.093	0.138	0.205	0.436	011	0401CPX-011A
0.500	0.390	0.093	0.138	0.205	0.499	012	0401CPX-012A
0.562	0.452	0.093	0.138	0.205	0.560	013	0401CPX-013A
0.625	0.515	0.093	0.138	0.205	0.623	014	0401CPX-014A
0.687	0.577	0.093	0.138	0.205	0.685	015	0401CPX-015A
0.750	0.640	0.093	0.138	0.205	0.748	016	0401CPX-016A
0.812	0.702	0.093	0.138	0.205	0.810	017	0401CPX-017A
0.875	0.765	0.093	0.138	0.205	0.873	018	0401CPX-018A
0.937	0.827	0.093	0.138	0.205	0.935	019	0401CPX-019A
1.000	0.890	0.093	0.138	0.205	0.998	020	0401CPX-020A
1.062	0.952	0.093	0.138	0.205	1.060	021	0401CPX-021A
1.125	1.015	0.093	0.138	0.205	1.123	022	0401CPX-022A
1.187	1.077	0.093	0.138	0.205	1.185	023	0401CPX-023A
1.250	1.140	0.093	0.138	0.205	1.248	024	0401CPX-024A

\*If used with wear rings, refer to wear ring piston diameter, see Section 9.



**CP Profile**

**Table 7-51. CP Gland Dimensions — Inch (Continued)**

A Bore Diameter	B Groove Diameter	C Groove Width (CP0)	C Groove Width (CP1)	C Groove Width (CP2)	D Piston Diameter* 5000 psi (345 bar)	O-ring Dash Number	CP Part Number (X = Groove Width of 0, 1 or 2)
<b>+0.002/-0.000</b>	<b>+0.000/-0.002</b>	<b>+0.005/-0.000</b>	<b>+0.005/-0.000</b>	<b>+0.005/-0.000</b>	<b>+0.00/-0.001</b>		
1.312	1.202	0.093	0.138	0.205	1.310	025	<b>0401CPX-025A</b>
1.375	1.265	0.093	0.138	0.205	1.373	026	<b>0401CPX-026A</b>
1.437	1.327	0.093	0.138	0.205	1.435	027	<b>0401CPX-027A</b>
1.500	1.390	0.093	0.138	0.205	1.498	028	<b>0401CPX-028A</b>
<b>+0.002/-0.000</b>	<b>+0.000/-0.002</b>	<b>+0.005/-0.000</b>	<b>+0.005/-0.000</b>	<b>+0.005/-0.000</b>	<b>+0.000/-0.002</b>		
0.312	0.136	0.140	0.171	0.238	0.311	104	<b>0401CPX-104A</b>
0.343	0.167	0.140	0.171	0.238	0.342	105	<b>0401CPX-105A</b>
0.375	0.199	0.140	0.171	0.238	0.374	106	<b>0401CPX-106A</b>
0.406	0.230	0.140	0.171	0.238	0.405	107	<b>0401CPX-107A</b>
0.437	0.261	0.140	0.171	0.238	0.436	108	<b>0401CPX-108A</b>
0.500	0.324	0.140	0.171	0.238	0.499	109	<b>0401CPX-109A</b>
0.562	0.386	0.140	0.171	0.238	0.561	110	<b>0401CPX-110A</b>
0.625	0.449	0.140	0.171	0.238	0.624	111	<b>0401CPX-111A</b>
0.687	0.511	0.140	0.171	0.238	0.686	112	<b>0401CPX-112A</b>
0.750	0.574	0.140	0.171	0.238	0.749	113	<b>0401CPX-113A</b>
0.812	0.636	0.140	0.171	0.238	0.811	114	<b>0401CPX-114A</b>
0.875	0.699	0.140	0.171	0.238	0.874	115	<b>0401CPX-115A</b>
0.937	0.761	0.140	0.171	0.238	0.936	116	<b>0401CPX-116A</b>
1.000	0.824	0.140	0.171	0.238	0.999	117	<b>0401CPX-117A</b>
1.062	0.886	0.140	0.171	0.238	1.061	118	<b>0401CPX-118A</b>
1.125	0.949	0.140	0.171	0.238	1.124	119	<b>0401CPX-119A</b>
1.187	1.011	0.140	0.171	0.238	1.186	120	<b>0401CPX-120A</b>
1.250	1.074	0.140	0.171	0.238	1.249	121	<b>0401CPX-121A</b>
1.312	1.136	0.140	0.171	0.238	1.311	122	<b>0401CPX-122A</b>
1.375	1.199	0.140	0.171	0.238	1.374	123	<b>0401CPX-123A</b>
1.437	1.261	0.140	0.171	0.238	1.436	124	<b>0401CPX-124A</b>
1.500	1.324	0.140	0.171	0.238	1.499	125	<b>0401CPX-125A</b>
1.562	1.386	0.140	0.171	0.238	1.561	126	<b>0401CPX-126A</b>
1.625	1.449	0.140	0.171	0.238	1.624	127	<b>0401CPX-127A</b>
1.687	1.511	0.140	0.171	0.238	1.686	128	<b>0401CPX-128A</b>
1.750	1.574	0.140	0.171	0.238	1.749	129	<b>0401CPX-129A</b>
1.812	1.636	0.140	0.171	0.238	1.810	130	<b>0401CPX-130A</b>
1.875	1.699	0.140	0.171	0.238	1.873	131	<b>0401CPX-131A</b>
1.937	1.761	0.140	0.171	0.238	1.935	132	<b>0401CPX-132A</b>
2.000	1.824	0.140	0.171	0.238	1.998	133	<b>0401CPX-133A</b>
2.062	1.886	0.140	0.171	0.238	2.060	134	<b>0401CPX-134A</b>
2.125	1.949	0.140	0.171	0.238	2.123	135	<b>0401CPX-135A</b>
2.187	2.011	0.140	0.171	0.238	2.185	136	<b>0401CPX-136A</b>
2.250	2.074	0.140	0.171	0.238	2.248	137	<b>0401CPX-137A</b>
2.312	2.136	0.140	0.171	0.238	2.310	138	<b>0401CPX-138A</b>
2.375	2.199	0.140	0.171	0.238	2.373	139	<b>0401CPX-139A</b>
2.437	2.261	0.140	0.171	0.238	2.435	140	<b>0401CPX-140A</b>
<b>+0.002/-0.000</b>	<b>+0.000/-0.002</b>	<b>+0.005/-0.000</b>	<b>+0.005/-0.000</b>	<b>.005/-0.000</b>	<b>+0.000/-0.003</b>		
2.500	2.324	0.140	0.171	0.238	2.498	141	<b>0401CPX-141A</b>
2.562	2.386	0.140	0.171	0.238	2.560	142	<b>0401CPX-142A</b>
2.625	2.449	0.140	0.171	0.238	2.623	143	<b>0401CPX-143A</b>
2.687	2.511	0.140	0.171	0.238	2.685	144	<b>0401CPX-144A</b>
2.750	2.574	0.140	0.171	0.238	2.748	145	<b>0401CPX-145A</b>
2.812	2.636	0.140	0.171	0.238	2.810	146	<b>0401CPX-146A</b>

\*If used with wear rings, refer to wear ring piston diameter, see Section 9.





Table 7-51. CP Gland Dimensions — Inch (Continued)

A Bore Diameter	B Groove Diameter	C Groove Width (CP0)	C Groove Width (CP1)	C Groove Width (CP2)	D Piston Diameter* 5000 psi (345 bar)	O-ring Dash Number	CP Part Number (X = Groove Width of 0, 1 or 2)
<b>+0.002/-0.000</b>	<b>+0.000/-0.002</b>	<b>+0.005/-0.000</b>	<b>+0.005/-0.000</b>	<b>.005/-0.000</b>	<b>+0.000/-0.003</b>		
2.875	2.699	0.140	0.171	0.238	2.873	147	0401CPX-147A
2.937	2.761	0.140	0.171	0.238	2.935	148	0401CPX-148A
3.000	2.824	0.140	0.171	0.238	2.998	149	0401CPX-149A
<b>+0.002/-0.000</b>	<b>+0.000/-0.002</b>	<b>+0.005/-0.000</b>	<b>+0.005/-0.000</b>	<b>+0.005/-0.000</b>	<b>+0.000/-0.002</b>		
0.437	0.195	0.187	0.208	0.275	0.436	201	0401CPX-201A
0.500	0.258	0.187	0.208	0.275	0.499	202	0401CPX-202A
0.562	0.320	0.187	0.208	0.275	0.561	203	0401CPX-203A
0.625	0.383	0.187	0.208	0.275	0.624	204	0401CPX-204A
0.687	0.445	0.187	0.208	0.275	0.686	205	0401CPX-205A
0.750	0.508	0.187	0.208	0.275	0.749	206	0401CPX-206A
0.812	0.570	0.187	0.208	0.275	0.811	207	0401CPX-207A
0.875	0.633	0.187	0.208	0.275	0.874	208	0401CPX-208A
0.937	0.695	0.187	0.208	0.275	0.936	209	0401CPX-209A
1.000	0.758	0.187	0.208	0.275	0.999	210	0401CPX-210A
1.062	0.820	0.187	0.208	0.275	1.061	211	0401CPX-211A
1.125	0.883	0.187	0.208	0.275	1.124	212	0401CPX-212A
1.187	0.945	0.187	0.208	0.275	1.186	213	0401CPX-213A
1.250	1.008	0.187	0.208	0.275	1.249	214	0401CPX-214A
1.312	1.070	0.187	0.208	0.275	1.311	215	0401CPX-215A
1.375	1.133	0.187	0.208	0.275	1.374	216	0401CPX-216A
1.437	1.195	0.187	0.208	0.275	1.436	217	0401CPX-217A
1.500	1.258	0.187	0.208	0.275	1.499	218	0401CPX-218A
1.562	1.320	0.187	0.208	0.275	1.561	219	0401CPX-219A
1.625	1.383	0.187	0.208	0.275	1.624	220	0401CPX-220A
1.687	1.445	0.187	0.208	0.275	1.686	221	0401CPX-221A
1.750	1.508	0.187	0.208	0.275	1.749	222	0401CPX-222A
1.875	1.633	0.187	0.208	0.275	1.873	223	0401CPX-223A
2.000	1.758	0.187	0.208	0.275	1.998	224	0401CPX-224A
2.125	1.883	0.187	0.208	0.275	2.123	225	0401CPX-225A
2.250	2.008	0.187	0.208	0.275	2.248	226	0401CPX-226A
2.375	2.133	0.187	0.208	0.275	2.373	227	0401CPX-227A
<b>+0.002/-0.000</b>	<b>+0.000/-0.002</b>	<b>+0.005/-0.000</b>	<b>+0.005/-0.000</b>	<b>+0.0005/-0.000</b>	<b>+0.000/-0.003</b>		
2.500	2.258	0.187	0.208	0.275	2.498	228	0401CPX-228A
2.625	2.383	0.187	0.208	0.275	2.623	229	0401CPX-229A
2.750	2.508	0.187	0.208	0.275	2.748	230	0401CPX-230A
2.875	2.633	0.187	0.208	0.275	2.873	231	0401CPX-231A
3.000	2.758	0.187	0.208	0.275	2.998	232	0401CPX-232A
3.125	2.883	0.187	0.208	0.275	3.123	233	0401CPX-233A
3.250	3.008	0.187	0.208	0.275	3.248	234	0401CPX-234A
3.375	3.133	0.187	0.208	0.275	3.373	235	0401CPX-235A
3.500	3.258	0.187	0.208	0.275	3.498	236	0401CPX-236A
3.625	3.383	0.187	0.208	0.275	3.623	237	0401CPX-237A
3.750	3.508	0.187	0.208	0.275	3.748	238	0401CPX-238A
3.875	3.633	0.187	0.208	0.275	3.873	239	0401CPX-239A
4.000	3.758	0.187	0.208	0.275	3.998	240	0401CPX-240A
4.125	3.883	0.187	0.208	0.275	4.123	241	0401CPX-241A
4.250	4.008	0.187	0.208	0.275	4.248	242	0401CPX-242A
4.375	4.133	0.187	0.208	0.275	4.373	243	0401CPX-243A
4.500	4.258	0.187	0.208	0.275	4.497	244	0401CPX-244A

\*If used with wear rings, refer to wear ring piston diameter, see Section 9.

7

**Table 7-51. CP Gland Dimensions — Inch (Continued)**

A Bore Diameter	B Groove Diameter	C Groove Width (CP0)	C Groove Width (CP1)	C Groove Width (CP2)	D Piston Diameter* 5000 psi (345 bar)	O-ring Dash Number	CP Part Number (X = Groove Width of 0, 1 or 2)
<b>+0.002/-0.000</b>	<b>+0.000/-0.002</b>	<b>+0.005/-0.000</b>	<b>+0.005/-0.000</b>	<b>+0.0005/-0.000</b>	<b>+0.000/-0.003</b>		
4.625	4.383	0.187	0.208	0.275	4.622	245	<b>0401CPX-245A</b>
4.750	4.508	0.187	0.208	0.275	4.747	246	<b>0401CPX-246A</b>
4.875	4.633	0.187	0.208	0.275	4.872	247	<b>0401CPX-247A</b>
5.000	4.758	0.187	0.208	0.275	4.997	248	<b>0401CPX-248A</b>
<b>+0.002/-0.000</b>	<b>+0.000/-0.002</b>	<b>+0.005/-0.000</b>	<b>+0.005/-0.000</b>	<b>+0.005/-0.000</b>	<b>+0.000/-0.002</b>		
0.812	0.442	0.281	0.311	0.410	0.810	309	<b>0401CPX-309A</b>
0.875	0.505	0.281	0.311	0.410	0.873	310	<b>0401CPX-310A</b>
0.937	0.567	0.281	0.311	0.410	0.935	311	<b>0401CPX-311A</b>
1.000	0.630	0.281	0.311	0.410	0.998	312	<b>0401CPX-312A</b>
1.062	0.692	0.281	0.311	0.410	1.060	313	<b>0401CPX-313A</b>
1.125	0.755	0.281	0.311	0.410	1.123	314	<b>0401CPX-314A</b>
1.187	0.817	0.281	0.311	0.410	1.185	315	<b>0401CPX-315A</b>
1.250	0.880	0.281	0.311	0.410	1.248	316	<b>0401CPX-316A</b>
1.312	0.942	0.281	0.311	0.410	1.310	317	<b>0401CPX-317A</b>
1.375	1.005	0.281	0.311	0.410	1.373	318	<b>0401CPX-318A</b>
1.437	1.067	0.281	0.311	0.410	1.435	319	<b>0401CPX-319A</b>
1.500	1.130	0.281	0.311	0.410	1.498	320	<b>0401CPX-320A</b>
1.562	1.192	0.281	0.311	0.410	1.560	321	<b>0401CPX-321A</b>
1.625	1.255	0.281	0.311	0.410	1.623	322	<b>0401CPX-322A</b>
1.687	1.317	0.281	0.311	0.410	1.685	323	<b>0401CPX-323A</b>
1.750	1.380	0.281	0.311	0.410	1.748	324	<b>0401CPX-324A</b>
1.875	1.505	0.281	0.311	0.410	1.873	325	<b>0401CPX-325A</b>
2.000	1.630	0.281	0.311	0.410	1.998	326	<b>0401CPX-326A</b>
2.125	1.755	0.281	0.311	0.410	2.123	327	<b>0401CPX-327A</b>
2.250	1.880	0.281	0.311	0.410	2.248	328	<b>0401CPX-328A</b>
2.375	2.005	0.281	0.311	0.410	2.373	329	<b>0401CPX-329A</b>
<b>+0.002/-0.000</b>	<b>+0.000/-0.002</b>	<b>+0.005/-0.000</b>	<b>+0.005/-0.000</b>	<b>+0.005/-0.000</b>	<b>+0.000/-0.003</b>		
2.500	2.130	0.281	0.311	0.410	2.498	330	<b>0401CPX-330A</b>
2.625	2.255	0.281	0.311	0.410	2.623	331	<b>0401CPX-331A</b>
2.750	2.380	0.281	0.311	0.410	2.748	332	<b>0401CPX-332A</b>
2.875	2.505	0.281	0.311	0.410	2.873	333	<b>0401CPX-333A</b>
3.000	2.630	0.281	0.311	0.410	2.998	334	<b>0401CPX-334A</b>
3.125	2.755	0.281	0.311	0.410	3.123	335	<b>0401CPX-335A</b>
3.250	2.880	0.281	0.311	0.410	3.248	336	<b>0401CPX-336A</b>
3.375	3.005	0.281	0.311	0.410	3.373	337	<b>0401CPX-337A</b>
3.500	3.130	0.281	0.311	0.410	3.498	338	<b>0401CPX-338A</b>
3.625	3.255	0.281	0.311	0.410	3.623	339	<b>0401CPX-339A</b>
3.750	3.380	0.281	0.311	0.410	3.748	340	<b>0401CPX-340A</b>
3.875	3.505	0.281	0.311	0.410	3.873	341	<b>0401CPX-341A</b>
4.000	3.630	0.281	0.311	0.410	3.998	342	<b>0401CPX-342A</b>
4.125	3.755	0.281	0.311	0.410	4.123	343	<b>0401CPX-343A</b>
4.250	3.880	0.281	0.311	0.410	4.247	344	<b>0401CPX-344A</b>
4.375	4.005	0.281	0.311	0.410	4.372	345	<b>0401CPX-345A</b>
<b>+0.002/-0.000</b>	<b>+0.000/-0.002</b>	<b>+0.005/-0.000</b>	<b>+0.005/-0.000</b>	<b>+0.005/-0.000</b>	<b>+0.000/-0.003</b>		
4.500	4.130	0.281	0.311	0.410	4.497	346	<b>0401CPX-346A</b>
4.625	4.255	0.281	0.311	0.410	4.622	347	<b>0401CPX-347A</b>
4.750	4.380	0.281	0.311	0.410	4.747	348	<b>0401CPX-348A</b>
4.875	4.505	0.281	0.311	0.410	4.872	349	<b>0401CPX-349A</b>
5.000	4.630	0.281	0.311	0.410	4.997	350	<b>0401CPX-350A</b>

\*If used with wear rings, refer to wear ring piston diameter, see Section 9.

Table 7-51. CP Gland Dimensions — Inch (Continued)

A Bore Diameter	B Groove Diameter	C Groove Width (CP0)	C Groove Width (CP1)	C Groove Width (CP2)	D Piston Diameter* 5000 psi (345 bar)	O-ring Dash Number	CP Part Number (X = Groove Width of 0, 1 or 2)
+ .002/- .000	+ .000/- .002	+ .005/- .000	+ .005/- .000	+ .005/- .000	+ .000/- .004		
5.000	4.526	0.375	0.408	0.538	4.997	425	0401CPX-425A
5.125	4.651	0.375	0.408	0.538	5.122	426	0401CPX-426A
5.250	4.776	0.375	0.408	0.538	5.247	427	0401CPX-427A
5.375	4.901	0.375	0.408	0.538	5.372	428	0401CPX-428A
5.500	5.026	0.375	0.408	0.538	5.497	429	0401CPX-429A
5.625	5.151	0.375	0.408	0.538	5.622	430	0401CPX-430A
5.750	5.276	0.375	0.408	0.538	5.747	431	0401CPX-431A
5.875	5.401	0.375	0.408	0.538	5.872	432	0401CPX-432A
6.000	5.526	0.375	0.408	0.538	5.997	433	0401CPX-433A
6.125	5.651	0.375	0.408	0.538	6.122	434	0401CPX-434A
6.250	5.776	0.375	0.408	0.538	6.247	435	0401CPX-435A
6.375	5.901	0.375	0.408	0.538	6.372	436	0401CPX-436A
6.500	6.026	0.375	0.408	0.538	6.497	437	0401CPX-437A
6.750	6.276	0.375	0.408	0.538	6.747	438	0401CPX-438A
7.000	6.526	0.375	0.408	0.538	6.997	439	0401CPX-439A
7.250	6.776	0.375	0.408	0.538	7.247	440	0401CPX-440A
7.500	7.026	0.375	0.408	0.538	7.497	441	0401CPX-441A
7.750	7.276	0.375	0.408	0.538	7.747	442	0401CPX-442A
8.000	7.526	0.375	0.408	0.538	7.997	443	0401CPX-443A
8.250	7.776	0.375	0.408	0.538	8.247	444	0401CPX-444A
8.500	8.026	0.375	0.408	0.538	8.497	445	0401CPX-445A
9.000	8.526	0.375	0.408	0.538	8.996	446	0401CPX-446A
9.500	9.026	0.375	0.408	0.538	9.496	447	0401CPX-447A
10.000	9.526	0.375	0.408	0.538	9.996	448	0401CPX-448A
10.500	10.026	0.375	0.408	0.538	10.496	449	0401CPX-449A
11.000	10.526	0.375	0.408	0.538	10.996	450	0401CPX-450A
11.500	11.026	0.375	0.408	0.538	11.496	451	0401CPX-451A
12.000	11.526	0.375	0.408	0.538	11.996	452	0401CPX-452A
12.500	12.026	0.375	0.408	0.538	12.496	453	0401CPX-453A
13.000	12.526	0.375	0.408	0.538	12.996	454	0401CPX-454A
13.500	13.026	0.375	0.408	0.538	13.496	455	0401CPX-455A
14.000	13.526	0.375	0.408	0.538	13.996	456	0401CPX-456A
14.500	14.026	0.375	0.408	0.538	14.496	457	0401CPX-457A
15.000	14.526	0.375	0.408	0.538	14.996	458	0401CPX-458A
15.500	15.026	0.375	0.408	0.538	15.496	459	0401CPX-459A
16.000	15.526	0.375	0.408	0.538	15.996	460	0401CPX-460A

\*If used with wear rings, refer to wear ring piston diameter, see Section 9.

NOTE: For sizes larger than those shown in the table, please contact your local Parker Seal representative.

# Piston Seal OA Profile

Catalog EPS 5370/USA

## OA Profile, Compact PTFE Piston Cap Seal



The Parker OA profile is a bi-directional piston seal for use in pneumatic and low to medium duty hydraulic applications. The OA profile is a two piece design utilizing a rectangular PTFE cap and standard size o-ring. The OA profile is an excellent choice for applications requiring a compact design. The unique properties of the modified PTFE provide added wear resistance for improved cycle life. Parker's OA profile will retrofit non-Parker seals of similar design.

The OA profile may be ordered without the energizer by omitting the energizer code. See part number nomenclature.

### Technical Data

Standard Materials*		Temperature Range	Pressure Range†	Surface Speed
<b>Cap</b>				
0102	Modified PTFE	-320°F to 450°F (-195°C to 282°C)	1,500 psi (103 bar)	< 13 ft/s (4 m/sec)
<b>Energizer</b>				
A	70A Nitrile	-30°F to 250°F (-34°C to 121°C)		

\***Alternate Materials:** For applications that may require an alternate material, please see Section 3 for alternate PTFE and energizer materials.

†**Pressure Range** without wear rings (see Table 2-4, page 2-5).

### Options

**Notched side walls:** Notches can be added to the side walls of the PTFE cap. This can help to optimize the seal's response to fluid pressure. Notched side walls help ensure that fluid pressure fills the cavity between the side face of the seal and the side face of the seal gland. Consult your local Parker Seal representative for the availability and cost to add side notches to the OA profile.

N = Notched walls 

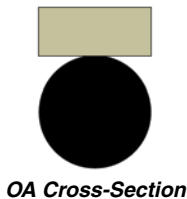

OA Cross-Section



OA Installed in Piston Gland

09/01/07

**Part Number Nomenclature —OA Profile**

Table 7-52. OA Profile — Inch

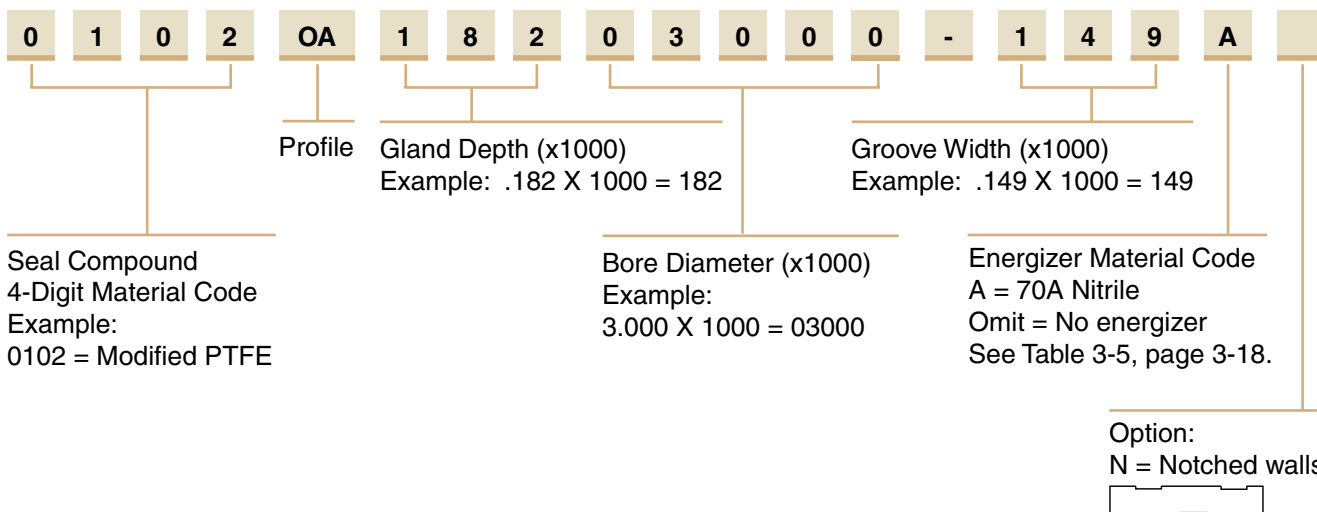

**Gland Dimensions — OA Profile**

Please refer to Engineering Section 2, Page 2-8 for surface finish and additional hardware considerations.

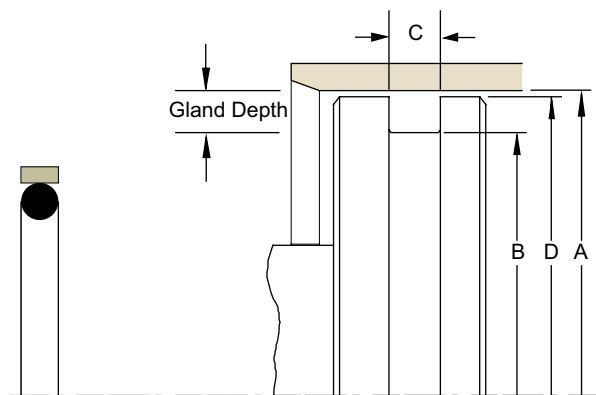

Table 7-53. OA Profile — Inch

A Bore Diameter	B Groove Diameter	C Groove Width	D Piston Diameter*	Max Radius	O-ring Dash Number	Part Number
<b>+.001/-.000</b>	<b>+.000/-.001</b>	<b>+.005/-.000</b>	<b>+.000/-.001</b>			
0.281	0.139	0.079	0.277	0.020	006	<b>0102OA07200281-079A</b>
0.312	0.169	0.079	0.308	0.020	007	<b>0102OA07200312-079A</b>
0.344	0.200	0.079	0.340	0.020	008	<b>0102OA07200344-079A</b>
0.375	0.231	0.079	0.371	0.020	009	<b>0102OA07200375-079A</b>
0.437	0.263	0.079	0.433	0.020	010	<b>0102OA07200437-079A</b>
0.500	0.326	0.079	0.496	0.020	011	<b>0102OA08700500-079A</b>
<b>+.002/-.000</b>	<b>+.000/-.002</b>	<b>+.005/-.000</b>	<b>+.000/-.001</b>			
0.562	0.388	0.079	0.557	0.020	012	<b>0102OA08700562-079A</b>
0.625	0.452	0.079	0.620	0.020	013	<b>0102OA08700625-079A</b>
0.687	0.515	0.079	0.682	0.020	014	<b>0102OA08700687-079A</b>
0.750	0.577	0.079	0.745	0.020	015	<b>0102OA08700750-079A</b>
0.812	0.640	0.079	0.807	0.020	016	<b>0102OA08700812-079A</b>
0.875	0.702	0.079	0.870	0.020	017	<b>0102OA08700875-079A</b>
0.937	0.765	0.079	0.932	0.020	018	<b>0102OA08700937-079A</b>
1.000	0.827	0.079	0.995	0.020	019	<b>0102OA08701000-079A</b>

\*If used with wear rings, refer to wear ring piston diameter, see Section 9.

Table 7-53. OA Gland Dimensions — Inch (Continued)

A Bore Diameter	B Groove Diameter	C Groove Width	D Piston Diameter*	Max Radius	O-ring Dash Number	Part Number
<b>+0.002/-0.000</b>	<b>+0.000/-0.002</b>	<b>+0.005/-0.000</b>	<b>+0.000/-0.001</b>			
1.062	0.890	0.079	1.057	0.020	020	0102OA08701062-079A
1.125	0.952	0.079	1.120	0.020	021	0102OA08701125-079A
1.187	1.015	0.079	1.182	0.020	022	0102OA08701187-079A
1.250	1.078	0.079	1.245	0.020	023	0102OA08701250-079A
1.312	1.140	0.079	1.307	0.020	024	0102OA08701312-079A
1.375	1.202	0.079	1.370	0.020	025	0102OA08701375-079A
1.437	1.265	0.079	1.432	0.020	026	0102OA08701437-079A
1.500	1.327	0.079	1.495	0.020	027	0102OA08701500-079A
<b>+0.003/-0.000</b>	<b>+0.000/-0.003</b>	<b>+0.005/-0.000</b>	<b>+0.000/-0.002</b>			
0.625	0.388	0.112	0.620	0.020	110	0102OA11800625-112A
0.687	0.451	0.112	0.682	0.020	111	0102OA11800687-112A
0.750	0.513	0.112	0.745	0.020	112	0102OA11800750-112A
0.812	0.576	0.112	0.807	0.020	113	0102OA11800812-112A
0.875	0.638	0.112	0.870	0.020	114	0102OA11800875-112A
0.937	0.701	0.112	0.932	0.020	115	0102OA11800937-112A
1.000	0.763	0.112	0.995	0.020	116	0102OA11801000-112A
1.062	0.826	0.112	1.057	0.020	117	0102OA11801062-112A
1.125	0.888	0.112	1.120	0.020	118	0102OA11801125-112A
1.187	0.951	0.112	1.182	0.020	119	0102OA11801187-112A
1.250	1.013	0.112	1.245	0.020	120	0102OA11801250-112A
1.312	1.076	0.112	1.307	0.020	121	0102OA11801312-112A
1.375	1.138	0.112	1.370	0.020	122	0102OA11801375-112A
1.437	1.201	0.112	1.432	0.020	123	0102OA11801437-112A
1.500	1.263	0.112	1.495	0.020	124	0102OA11801500-112A
1.562	1.326	0.112	1.557	0.020	125	0102OA11801562-112A
1.625	1.388	0.112	1.620	0.020	126	0102OA11801625-112A
1.687	1.451	0.112	1.682	0.020	127	0102OA11801687-112A
1.750	1.513	0.112	1.745	0.020	128	0102OA11801750-112A
1.812	1.576	0.112	1.807	0.020	129	0102OA11801812-112A
1.875	1.638	0.112	1.870	0.020	130	0102OA11801875-112A
1.937	1.701	0.112	1.932	0.020	131	0102OA11801937-112A
2.000	1.763	0.112	1.995	0.020	132	0102OA11802000-112A
2.062	1.826	0.112	2.057	0.020	133	0102OA11802062-112A
2.125	1.888	0.112	2.120	0.020	134	0102OA11802125-112A
2.187	1.951	0.112	2.182	0.020	135	0102OA11802187-112A
2.250	2.013	0.112	2.245	0.020	136	0102OA11802250-112A
2.312	2.076	0.112	2.307	0.020	137	0102OA11802312-112A
2.375	2.138	0.112	2.370	0.020	138	0102OA11802375-112A
2.437	2.201	0.112	2.432	0.020	139	0102OA11802437-112A
2.500	2.263	0.112	2.495	0.020	140	0102OA11802500-112A
2.562	2.326	0.112	2.557	0.020	141	0102OA11802562-112A
2.625	2.388	0.112	2.620	0.020	142	0102OA11802625-112A
2.687	2.451	0.112	2.682	0.020	143	0102OA11802687-112A
2.750	2.513	0.112	2.745	0.020	144	0102OA11802750-112A
2.812	2.576	0.112	2.807	0.020	145	0102OA11802812-112A
2.875	2.638	0.112	2.870	0.020	146	0102OA11802875-112A
2.937	2.701	0.112	2.932	0.020	147	0102OA11802937-112A
3.000	2.763	0.112	2.995	0.020	148	0102OA11803000-112A

\*If used with wear rings, refer to wear ring piston diameter, see Section 9.



Table 7-53. OA Gland Dimensions — Inch (Continued)

A Bore Diameter	B Groove Diameter	C Groove Width	D Piston Diameter*	Max Radius	O-ring Dash Number	Part Number
<b>+ .004/- .000</b>	<b>+ .000/- .004</b>	<b>+ .005/- .000</b>	<b>+ .000/- .002</b>			
1.062	0.762	0.149	1.056	0.030	210	0102OA15001062-149A
1.125	0.824	0.149	1.119	0.030	211	0102OA15001125-149A
1.187	0.887	0.149	1.181	0.030	212	0102OA15001187-149A
1.250	0.950	0.149	1.244	0.030	213	0102OA15001250-149A
1.312	1.012	0.149	1.306	0.030	214	0102OA15001312-149A
1.375	1.074	0.149	1.369	0.030	215	0102OA15001375-149A
1.437	1.137	0.149	1.431	0.030	216	0102OA15001437-149A
1.500	1.199	0.149	1.494	0.030	217	0102OA15001500-149A
1.562	1.262	0.149	1.556	0.030	218	0102OA15001562-149A
1.625	1.324	0.149	1.619	0.030	219	0102OA15001625-149A
1.687	1.387	0.149	1.681	0.030	220	0102OA15001687-149A
1.750	1.450	0.149	1.744	0.030	221	0102OA15001750-149A
1.875	1.512	0.149	1.869	0.030	222	0102OA18201875-149A
2.000	1.637	0.149	1.994	0.030	223	0102OA18202000-149A
2.125	1.762	0.149	2.119	0.030	224	0102OA18202125-149A
2.250	1.887	0.149	2.244	0.030	225	0102OA18202250-149A
2.375	2.012	0.149	2.369	0.030	226	0102OA18202375-149A
2.500	2.137	0.149	2.494	0.030	227	0102OA18202500-149A
2.625	2.262	0.149	2.619	0.030	228	0102OA18202625-149A
2.750	2.387	0.149	2.744	0.030	229	0102OA18202750-149A
2.875	2.512	0.149	2.869	0.030	230	0102OA18202875-149A
3.000	2.637	0.149	2.994	0.030	231	0102OA18203000-149A
3.125	2.762	0.149	3.119	0.030	232	0102OA18203125-149A
3.250	2.887	0.149	3.244	0.030	233	0102OA18203250-149A
3.375	3.012	0.149	3.369	0.030	234	0102OA18203375-149A
3.500	3.137	0.149	3.494	0.030	235	0102OA18203500-149A
3.625	3.262	0.149	3.619	0.030	236	0102OA18203625-149A
3.750	3.387	0.149	3.744	0.030	237	0102OA18203750-149A
3.875	3.512	0.149	3.869	0.030	238	0102OA18203875-149A
4.000	3.637	0.149	3.994	0.030	239	0102OA18204000-149A
4.125	3.762	0.149	4.119	0.030	240	0102OA18204125-149A
4.250	3.887	0.149	4.244	0.030	241	0102OA18204250-149A
4.375	4.012	0.149	4.369	0.030	242	0102OA18204375-149A
4.500	4.137	0.149	4.494	0.030	243	0102OA18204500-149A
4.625	4.262	0.149	4.619	0.030	244	0102OA18204625-149A
4.750	4.387	0.149	4.744	0.030	245	0102OA18204750-149A
4.875	4.512	0.149	4.869	0.030	246	0102OA18204875-149A
5.000	4.637	0.149	4.994	0.030	247	0102OA18205000-149A
<b>+ .005/- .000</b>	<b>+ .000/- .005</b>	<b>+ .005/- .000</b>	<b>+ .000/- .002</b>			
2.000	1.509	0.221	1.993	0.050	325	0102OA24602000-221A
2.125	1.634	0.221	2.118	0.050	326	0102OA24602125-221A
2.250	1.759	0.221	2.243	0.050	327	0102OA24602250-221A
2.375	1.884	0.221	2.368	0.050	328	0102OA24602375-221A
2.500	2.009	0.221	2.493	0.050	329	0102OA24602500-221A
2.625	2.134	0.221	2.618	0.050	330	0102OA24602625-221A
2.750	2.259	0.221	2.743	0.050	331	0102OA24602750-221A
2.875	2.384	0.221	2.868	0.050	332	0102OA24602875-221A
3.000	2.509	0.221	2.993	0.050	333	0102OA24603000-221A

\*If used with wear rings, refer to wear ring piston diameter, see Section 9.

Table 7-53. OA Gland Dimensions — Inch (Continued)

A Bore Diameter	B Groove Diameter	C Groove Width	D Piston Diameter*	Max Radius	O-ring Dash Number	Part Number
<b>+0.005/-0.000</b>	<b>+0.000/-0.005</b>	<b>+0.005/-0.000</b>	<b>+0.000/-0.002</b>			
3.125	2.634	0.221	3.118	0.050	334	0102OA24603125-221A
3.250	2.759	0.221	3.243	0.050	335	0102OA24603250-221A
3.375	2.884	0.221	3.368	0.050	336	0102OA24603375-221A
3.500	3.009	0.221	3.493	0.050	337	0102OA24603500-221A
3.625	3.134	0.221	3.618	0.050	338	0102OA24603625-221A
3.750	3.259	0.221	3.743	0.050	339	0102OA24603750-221A
3.875	3.384	0.221	3.868	0.050	340	0102OA24603875-221A
4.000	3.509	0.221	3.993	0.050	341	0102OA24604000-221A
4.125	3.634	0.221	4.118	0.050	342	0102OA24604125-221A
4.250	3.759	0.221	4.243	0.050	343	0102OA24604250-221A
4.375	3.884	0.221	4.368	0.050	344	0102OA24604375-221A
4.500	4.009	0.221	4.493	0.050	345	0102OA24604500-221A
4.625	4.134	0.221	4.618	0.050	346	0102OA24604625-221A
4.750	4.259	0.221	4.743	0.050	347	0102OA24604750-221A
4.875	4.384	0.221	4.868	0.050	348	0102OA24604875-221A
5.000	4.509	0.221	4.993	0.050	349	0102OA24605000-221A
<b>+0.006/-0.000</b>	<b>+0.000/-0.006</b>	<b>+0.005/-0.000</b>	<b>+0.000/-0.002</b>			
5.125	4.532	0.297	5.117	0.060	425	0102OA29705125-297A
5.250	4.657	0.297	5.242	0.060	426	0102OA29705250-297A
5.375	4.782	0.297	5.367	0.060	427	0102OA29705375-297A
5.500	4.907	0.297	5.492	0.060	428	0102OA29705500-297A
5.625	5.032	0.297	5.617	0.060	429	0102OA29705625-297A
5.750	5.157	0.297	5.742	0.060	430	0102OA29705750-297A
5.875	5.282	0.297	5.867	0.060	431	0102OA29705875-297A
6.000	5.407	0.297	5.992	0.060	432	0102OA29706000-297A
6.125	5.532	0.297	6.117	0.060	433	0102OA29706125-297A
6.250	5.657	0.297	6.242	0.060	434	0102OA29706250-297A
6.375	5.782	0.297	6.367	0.060	435	0102OA29706375-297A
6.500	5.907	0.297	6.492	0.060	436	0102OA29706500-297A
6.750	6.032	0.297	6.742	0.060	437	0102OA35906750-297A
7.000	6.282	0.297	6.992	0.060	438	0102OA35907000-297A
7.250	6.532	0.297	7.242	0.060	439	0102OA35907250-297A
7.500	6.782	0.297	7.492	0.060	440	0102OA35907500-297A
7.750	7.032	0.297	7.742	0.060	441	0102OA35907750-297A
8.000	7.282	0.297	7.992	0.060	442	0102OA35908000-297A
8.250	7.532	0.297	8.242	0.060	443	0102OA35908250-297A
8.500	7.782	0.297	8.492	0.060	444	0102OA35908500-297A
9.000	8.032	0.297	8.992	0.060	445	0102OA48409000-297A
9.500	8.532	0.297	9.492	0.060	446	0102OA48409500-297A
10.000	9.032	0.297	9.992	0.060	447	0102OA48410000-297A
<b>+0.003/-0.000</b>	<b>+0.000/-0.003</b>	<b>+0.005/-0.000</b>	<b>+0.000/-0.002</b>			
10.500	9.532	0.297	10.492	0.060	448	0102OA48410500-297A
11.000	10.032	0.297	10.992	0.060	449	0102OA48411000-297A
11.500	10.532	0.297	11.492	0.060	450	0102OA48411500-297A
12.000	11.032	0.297	11.992	0.060	451	0102OA48412000-297A
12.500	11.532	0.297	12.492	0.060	452	0102OA48412500-297A
13.000	12.032	0.297	12.992	0.060	453	0102OA48413000-297A
13.500	12.532	0.297	13.492	0.060	454	0102OA48413500-297A
14.000	13.032	0.297	13.992	0.060	455	0102OA48414000-297A

\*If used with wear rings, refer to wear ring piston diameter, see Section 9.

09/01/07

**Table 7-53. OA Gland Dimensions — Inch (Continued)**

A Bore Diameter	B Groove Diameter	C Groove Width	D Piston Diameter*	Max Radius	O-ring Dash Number	Part Number
<b>+.003/-0.000</b>	<b>+.000/-0.003</b>	<b>+.005/-0.000</b>	<b>+.000/-0.002</b>			
14.500	13.532	0.297	14.492	0.060	456	<b>0102OA48414500-297A</b>
15.000	14.032	0.297	14.992	0.060	457	<b>0102OA48415000-297A</b>
15.500	14.532	0.297	15.492	0.060	458	<b>0102OA48415500-297A</b>
16.000	15.032	0.297	15.992	0.060	459	<b>0102OA48416000-297A</b>

\*If used with wear rings, refer to wear ring piston diameter, see Section 9.

NOTE: For sizes larger than those shown in the table, please contact your local Parker Seal representative.

# Piston Seal OQ Profile

Catalog EPS 5370/USA



## OQ Profile, Rotary PTFE Cap Seal

The Parker OQ profile is a bi-directional piston seal for use in low to medium duty rotary or oscillating applications. The OQ profile is a two piece design comprised of a standard size o-ring energizing a wear resistant PTFE cap. The OQ profile offers long wear and low friction, without stickslip. The PTFE inner diameter is designed with a special interference with the o-ring to eliminate spinning between the o-ring and seal. Special grooves are designed into the PTFE outer diameter to provide lubrication and create a labyrinth effect for reduced leakage. Parker's OQ profile will retrofit non-Parker seals of similar design.

The OQ profile may be ordered without the energizer by omitting the energizer code. See part number nomenclature.

### Technical Data

Standard Materials*	Temperature Range	Pressure Range†	Surface Speed
<b>Cap</b> 0205 15% fiberglass-, 5% molybdenum disulfide-filled PTFE	-200°F to 575°F (-129°C to 302°C)	3000 psi (206 bar)	< 3.3 ft/s (1.0 m/sec)
<b>Energizer</b> A 70A Nitrile	-30°F to 250°F (-34°C to 121°C)		

\***Alternate Materials:** For applications that may require an alternate material, please see Section 3 for alternate PTFE (Table 3-4) and energizer (Table 3-5) materials.

†**Pressure Range** without wear rings (see Table 2-4, page 2-5).

### Options

**Metric:** For metric part numbering and availability, see Tables 7-56 and 7-57 on pages 7-77 through 7-79.



OQ Cross-Section



OQ installed in Rotary Gland

09/01/07

### Part Number Nomenclature — OQ Profile

Table 7-54. OQ Profile — Inch

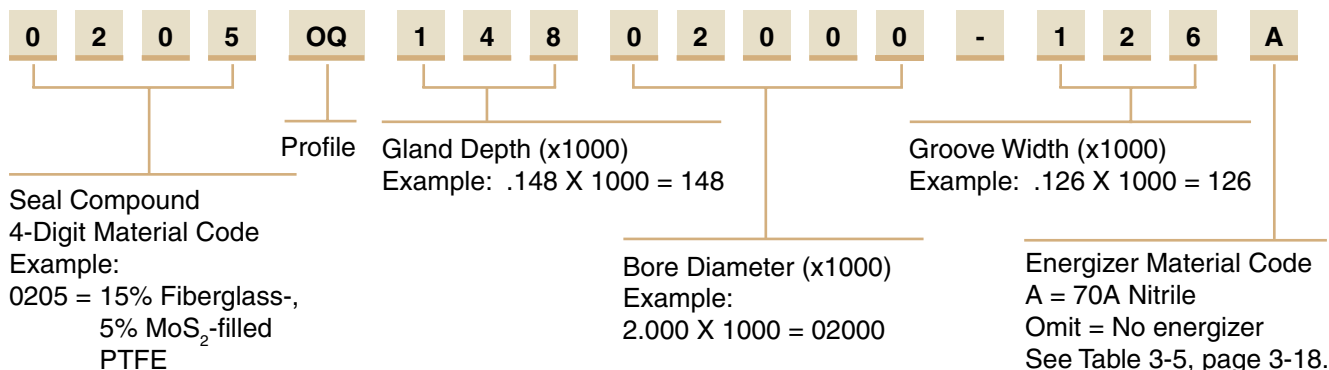

### Gland Dimensions — OQ Profile

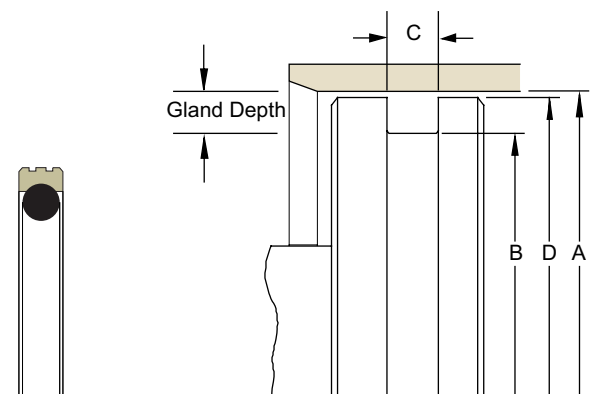

Please refer to Engineering Section 2, Page 2-8 for surface finish and additional hardware considerations.

Table 7-55. OQ Profile — Inch

A Bore Diameter	B Groove Diameter	C Groove Width	D Piston Diameter*	O-ring Dash Number	Part Number
+0.001/-0.000	+0.000/-0.001	+0.008/-0.000	+0.000/-0.002		
0.375	0.182	0.087	0.374	008	0205OQ09700375-087A
+0.002/-0.000	+0.000/-0.002	+0.008/-0.000	+0.000/-0.002		
0.438	0.245	0.087	0.437	010	0205OQ09700438-087A
0.500	0.307	0.087	0.499	011	0205OQ09700500-087A
0.563	0.370	0.087	0.562	012	0205OQ09700563-087A
0.625	0.432	0.087	0.624	013	0205OQ09700625-087A
0.688	0.495	0.087	0.687	014	0205OQ09700688-087A
0.750	0.557	0.087	0.749	015	0205OQ09700750-087A
0.813	0.620	0.087	0.812	016	0205OQ09700813-087A
0.875	0.682	0.087	0.874	017	0205OQ09700875-087A
0.938	0.745	0.087	0.937	018	0205OQ09700938-087A
1.000	0.807	0.087	0.999	019	0205OQ09701000-087A
1.125	0.932	0.087	1.124	021	0205OQ09701125-087A
1.250	1.057	0.087	1.249	023	0205OQ09701250-087A
1.375	1.182	0.087	1.374	025	0205OQ09701375-087A
+0.002/-0.000	+0.000/-0.002	+0.008/-0.000	+0.000/-0.002		
1.500	1.205	0.126	1.499	123	0205OQ14801500-126A
1.625	1.330	0.126	1.624	125	0205OQ14801625-126A
1.750	1.455	0.126	1.749	127	0205OQ14801750-126A
1.875	1.580	0.126	1.874	129	0205OQ14801875-126A

\*If used with wear rings, refer to wear ring piston diameter, see Section 9.



**Table 7-55. OQ Gland Dimensions — Inch (Continued)**

A Bore Diameter	B Groove Diameter	C Groove Width	D Piston Diameter*	O-ring Dash Number	Part Number
<b>+ .003/- .000</b>	<b>+ .000/- .003</b>	<b>+ .008/- .000</b>	<b>+ .000/- .002</b>		
2.000	1.705	0.126	1.999	131	0205OQ14802000-126A
2.125	1.830	0.126	2.124	133	0205OQ14802125-126A
2.250	1.955	0.126	2.249	135	0205OQ14802250-126A
2.375	2.080	0.126	2.374	137	0205OQ14802375-126A
2.500	2.205	0.126	2.499	139	0205OQ14802500-126A
2.625	2.330	0.126	2.624	141	0205OQ14802625-126A
2.750	2.455	0.126	2.749	143	0205OQ14802750-126A
2.875	2.580	0.126	2.874	145	0205OQ14802875-126A
<b>+ .003/- .000</b>	<b>+ .000/- .003</b>	<b>+ .008/- .000</b>	<b>+ .000/- .003</b>		
3.000	2.567	0.165	2.999	230	0205OQ21703000-165A
3.125	2.692	0.165	3.124	231	0205OQ21703125-165A
3.250	2.817	0.165	3.249	232	0205OQ21703250-165A
3.375	2.942	0.165	3.374	233	0205OQ21703375-165A
3.500	3.067	0.165	3.499	234	0205OQ21703500-165A
3.625	3.192	0.165	3.624	235	0205OQ21703625-165A
3.750	3.317	0.165	3.749	236	0205OQ21703750-165A
3.875	3.442	0.165	3.874	237	0205OQ21703875-165A
4.000	3.567	0.165	3.999	238	0205OQ21704000-165A
4.125	3.692	0.165	4.124	239	0205OQ21704125-165A
4.250	3.817	0.165	4.249	240	0205OQ21704250-165A
4.375	3.942	0.165	4.374	241	0205OQ21704375-165A
4.500	4.067	0.165	4.499	242	0205OQ21704500-165A
4.625	4.192	0.165	4.624	243	0205OQ21704625-165A
<b>+ .004/- .000</b>	<b>+ .000/- .004</b>	<b>+ .008/- .000</b>	<b>+ .000/- .003</b>		
4.750	4.317	0.165	4.749	244	0205OQ21704750-165A
4.875	4.442	0.165	4.874	245	0205OQ21704875-165A
5.000	4.567	0.165	4.999	246	0205OQ21705000-165A
5.125	4.692	0.165	5.124	247	0205OQ21705125-165A
5.250	4.817	0.165	5.249	248	0205OQ21705250-165A
5.375	4.942	0.165	5.374	249	0205OQ21705375-165A
5.500	5.067	0.165	5.499	250	0205OQ21705500-165A
5.625	5.192	0.165	5.624	251	0205OQ21705625-165A
5.750	5.317	0.165	5.749	252	0205OQ21705750-165A
5.875	5.442	0.165	5.874	253	0205OQ21705875-165A
<b>+ .004/- .000</b>	<b>+ .000/- .004</b>	<b>+ .008/- .000</b>	<b>+ .000/- .004</b>		
6.000	5.390	0.248	5.999	355	0205OQ30506000-248A
6.250	5.640	0.248	6.249	357	0205OQ30506250-248A
6.500	5.890	0.248	6.499	359	0205OQ30506500-248A
6.750	6.140	0.248	6.749	361	0205OQ30506750-248A
7.000	6.390	0.248	6.999	362	0205OQ30507000-248A
<b>+ .005/- .000</b>	<b>+ .000/- .005</b>	<b>+ .008/- .000</b>	<b>+ .000/- .004</b>		
7.250	6.640	0.248	7.248	363	0205OQ30507250-248A
7.500	6.890	0.248	7.498	364	0205OQ30507500-248A
7.750	7.140	0.248	7.748	365	0205OQ30507750-248A

\*If used with wear rings, refer to wear ring piston diameter, see Section 9.



**Table 7-55. OQ Gland Dimensions — Inch (Continued)**

A Bore Diameter	B Groove Diameter	C Groove Width	D Piston Diameter*	O-ring Dash Number	Part Number
<b>+ .005/- .000</b>	<b>+ .000/- .005</b>	<b>+ .008/- .000</b>	<b>+ .000/- .004</b>		
8.000	7.390	0.248	7.998	366	0205OQ30508000-248A
8.250	7.640	0.248	8.248	367	0205OQ30508250-248A
8.500	7.890	0.248	8.498	368	0205OQ30508500-248A
8.750	8.140	0.248	8.748	369	0205OQ30508750-248A
9.000	8.390	0.248	8.998	370	0205OQ30509000-248A
9.250	8.640	0.248	9.248	371	0205OQ30509250-248A
9.500	8.890	0.248	9.498	372	0205OQ30509500-248A
9.750	9.140	0.248	9.748	373	0205OQ30509750-248A
10.000	9.390	0.248	9.998	374	0205OQ30510000-248A
10.500	9.890	0.248	10.498	376	0205OQ30510500-248A
11.000	10.390	0.248	10.998	377	0205OQ30511000-248A
11.500	10.890	0.248	11.498	378	0205OQ30511500-248A
<b>+ .006/- .000</b>	<b>+ .000/- .006</b>	<b>+ .008/- .000</b>	<b>+ .000/- .005</b>		
12.000	11.173	0.319	11.998	451	0205OQ41412000-319A
12.500	11.673	0.319	12.498	452	0205OQ41412500-319A
13.000	12.173	0.319	12.998	453	0205OQ41413000-319A
13.500	12.673	0.319	13.498	454	0205OQ41413500-319A
14.000	13.173	0.319	13.998	455	0205OQ41414000-319A
14.500	13.673	0.319	14.498	456	0205OQ41414500-319A
15.000	14.173	0.319	14.998	457	0205OQ41415000-319A
15.500	14.673	0.319	15.498	458	0205OQ41415500-319A
16.000	15.173	0.319	15.998	459	0205OQ41416000-319A
16.500	15.673	0.319	16.498	460	0205OQ41416500-319A
17.000	16.173	0.319	16.998	461	0205OQ41417000-319A
17.500	16.673	0.319	17.498	462	0205OQ41417500-319A
18.000	17.173	0.319	17.998	463	0205OQ41418000-319A
18.500	17.673	0.319	18.498	464	0205OQ41418500-319A
19.000	18.173	0.319	18.998	465	0205OQ41419000-319A
19.500	18.673	0.319	19.498	466	0205OQ41419500-319A
<b>+ .007/- .000</b>	<b>+ .000/- .007</b>	<b>+ .008/- .000</b>	<b>+ .000/- .005</b>		
20.000	19.173	0.319	19.998	467	0205OQ41420000-319A

\*If used with wear rings, refer to wear ring piston diameter, see Section 9.

NOTE: For sizes larger than those shown in the table, please contact your local Parker Seal representative.

**Part Number Nomenclature —OQ Profile**

**Table 7-56. OQ Profile — Metric**

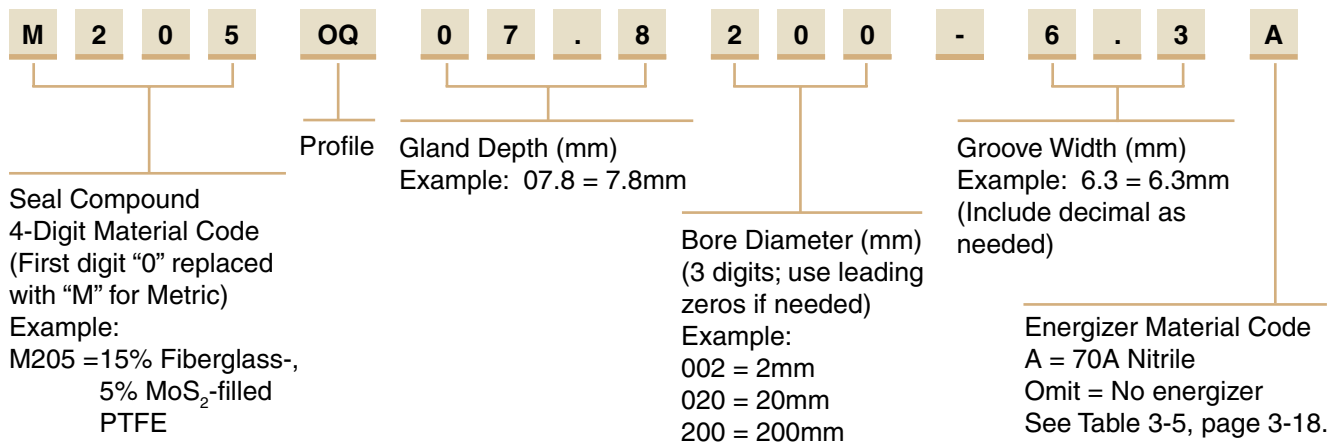

09/01/07



**Gland Dimensions — OQ Profile**

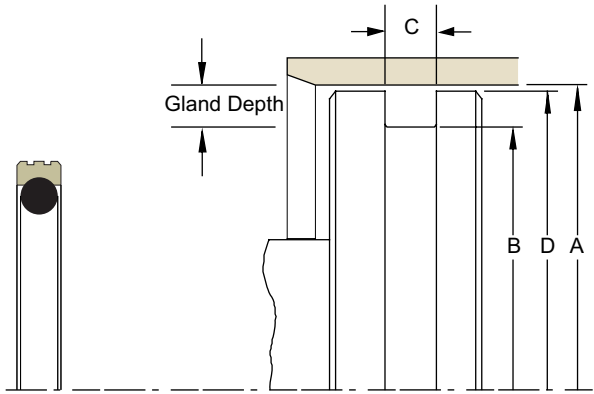

Please refer to Engineering Section 2, Page 2-8 for surface finish and additional hardware considerations.

**Table 7-57. OQ Profile — Metric**

A Bore Diameter	B Groove Diameter	C Groove Width	D Piston Diameter*	O-ring Dash Number	Part Number
H9	h9	+0.20/-0.00	h8		
8.00	3.10	2.20	7.97	006	M205OQ02.5008-2.2A
10.00	5.10	2.20	9.97	008	M205OQ02.5010-2.2A
12.00	7.10	2.20	11.97	010	M205OQ02.5012-2.2A
16.00	11.10	2.20	15.97	016	M205OQ02.5016-2.2A
20.00	15.10	2.20	19.97	015	M205OQ02.5020-2.2A
22.00	17.10	2.20	21.97	016	M205OQ02.5022-2.2A
25.00	20.10	2.20	24.97	018	M205OQ02.5025-2.2A
30.00	25.10	2.20	29.97	021	M205OQ02.5030-2.2A
32.00	27.10	2.20	31.97	023	M205OQ02.5032-2.2A
40.00	32.50	3.20	39.94	124	M205OQ03.8040-3.2A
45.00	37.50	3.20	44.94	127	M205OQ03.8045-3.2A
50.00	42.50	3.20	49.94	130	M205OQ03.8050-3.2A
55.00	47.50	3.20	54.94	133	M205OQ03.8055-3.2A
63.00	55.50	3.20	62.94	138	M205OQ03.8063-3.2A
70.00	62.50	3.20	69.94	143	M205OQ03.8070-3.2A
80.00	69.00	4.20	79.90	231	M205OQ05.5080-4.2A
90.00	79.00	4.20	89.90	234	M205OQ05.5090-4.2A
100.00	89.00	4.20	99.90	237	M205OQ05.5100-4.2A
110.00	99.00	4.20	109.90	241	M205OQ05.5110-4.2A
120.00	109.00	4.20	119.90	244	M205OQ05.5120-4.2A
125.00	114.00	4.20	124.90	245	M205OQ05.5125-4.2A
130.00	119.00	4.20	129.90	247	M205OQ05.5130-4.2A
140.00	124.50	6.30	139.90	352	M205OQ07.8140-6.3A
150.00	134.50	6.30	149.90	355	M205OQ07.8150-6.3A
160.00	144.50	6.30	159.90	358	M205OQ07.8160-6.3A
200.00	184.50	6.30	199.90	366	M205OQ07.8200-6.3A
220.00	204.50	6.30	219.90	369	M205OQ07.8220-6.3A
230.00	214.50	6.30	229.90	370	M205OQ07.8230-6.3A
240.00	224.50	6.30	239.90	372	M205OQ07.8240-6.3A
250.00	234.50	6.30	249.90	374	M205OQ07.8250-6.3A
300.00	284.50	6.30	299.90	379	M205OQ07.8300-6.3A
320.00	304.50	6.30	319.90	381	M205OQ07.8320-6.3A
400.00	379.00	8.10	399.90	458	M205OQ10.5400-8.1A
500.00	479.00	8.10	499.90	467	M205OQ10.5500-8.1A
600.00	579.00	8.10	599.90	472	M205OQ10.5600-8.1A

\*If used with wear rings, refer to wear ring piston diameter, see Section 9.

NOTE: For sizes larger than those shown in the table, please contact your local Parker Seal representative.

## Contents

Product Offering .....	8-3
Decision Tree .....	8-4
Product Profiles	
YD .....	8-5
SHD .....	8-6
SHX .....	8-7
SH959 .....	8-11
SX959 .....	8-12
AH .....	8-15
J .....	8-17
AY .....	8-19
H / 8600 .....	8-21
K .....	8-27
AD .....	8-30
SG .....	8-36

## Wiper Introduction

One of the primary causes of premature component failure in a fluid power system is contamination. Contaminants such as moisture, dirt, and dust can cause extensive damage to cylinder walls, rods, seals and other components. It has always been Parker's design philosophy to use aggressive wiping geometries to prevent the damage that is caused when trace amounts of dirt or water are allowed to enter a fluid power system. This philosophy goes hand in hand with reducing the down time and high costs associated with replacing rusted components, scored rods, filters and leaking seals.

### Choosing a Wiper

Some of the considerations that need to be made when choosing a wiper include:

1. Application Requirements
2. Groove Geometry
3. Lip Geometry
4. Redundant Sealing Lips
5. Environment
6. Rod Seal Interaction

Also see the Wiper Decision Tree found on page 8-4.

**1. Application Requirements:** Whether hydraulic or pneumatic, high temperature, or low friction, Parker's broad range of materials and wiper profiles allow you to choose the right wiper for every application.

**2. Groove Geometry:** When choosing the groove geometry, machining costs, wiper costs and the costs of replacing the wiper while in the field must be considered. The majority of mobile equipment manufacturers use press-fit canned wipers. While canned wipers are more costly, the gland machining costs are less and the wiper lips are more aggressive for this harsh environment.

**3. Lip Geometry:** Parker wipers are designed to give the best possible exclusion performance by featuring perpendicular, or "straight-cut" lip geometries. The footprint of a sharp, straight-cut wiper causes a high concentration of forces which maximizes fluid film breakage while allowing contaminants to be pushed away from the wiping edge. (See Figure 8-1.) The footprint of a radiused lip, however,

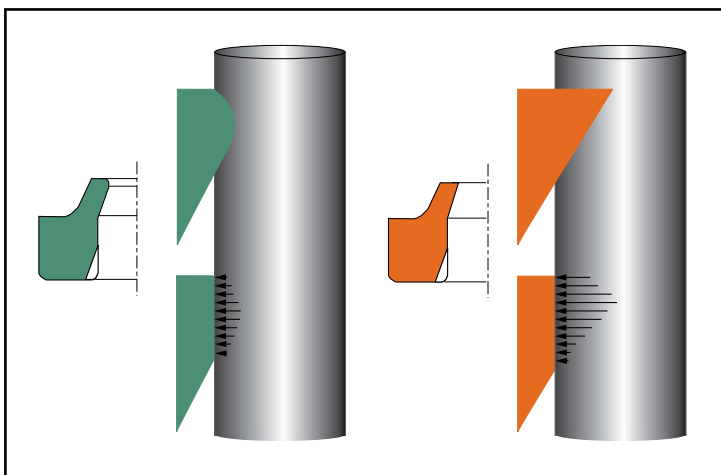

Figure 8-1. Radius vs. Straight Cut Lip Geometry



## Wipers

often results in a poor concentration of forces. Although they are less costly, radiused lip geometries can also trap contamination against the rod, lifting the wiper up and opening a gateway for further contamination. For ultimate performance, Parker offers profiles with a knife trimmed wiping lip. These profiles include the YD and J profiles.

- 4. Redundant Sealing Lips:** One of the most effective ways to improve a system's sealing performance is to incorporate the use of multiple or redundant sealing lips. This can be accomplished by using Parker's AY, AH, H or 8600, doubled lip profiles. Because these wipers have a redundant sealing lip, there is no way for them to relieve a pressure trap out of the system. It is critical, therefore, to pair redundant lip wipers with the correct rod seals, such as the BT and B3 u-cup profiles. These rod seal profiles enable fluid pressure relief back into the system.
- 5. Environment:** In certain applications where cylinders are in a vertical or rod-up orientation, it's possible for moisture or other contaminants to collect in the wiper gland. These situations can be found in everything from forklifts and agricultural cylinders to heavy duty construction equipment that is exposed to all-weather conditions. For this reason, Parker offers

several wiper profiles that feature O.D. exclusion technology to keep contamination out on both the dynamic and static surfaces. For snap-in applications, the Parker YD, SHX and SX959 profiles offer an additional lip contact to exclude contamination at the O.D. For more aggressive sealing at the O.D., Parker offers the AH and J style metal encased wipers which utilize a metal to metal interference fit for high performance in harsh environments.

- 6. Rod Seal Interaction:** It is important to properly pair rod seals and wiper combinations to minimize leakage. When the rod extends past the rod seal, there is a thin film of oil that remains trapped in microscopic surface imperfections. The thickness of this film depends on the aggressiveness of the rod seal, rod surface finish and rod speed. If the rod seal chosen is less aggressive than the wiper, the wiper can wipe away the oil film during retract, resulting in system leakage.





























Examples of poor wiper/rod seal combinations include using a soft rubber u-cup with an aggressive urethane wiper, or a rod seal with net molded lips paired with a knife trimmed wiper. In both cases a less aggressive rod seal is improperly paired with a more aggressive wiper.

# Wiper Product Offering

Catalog EPS 5370/USA

## Profiles

Table 8-1: Product Profiles

Series	Description	Application (Duty)				Page	Series	Description	Application (Duty)				Page
		Light	Medium	Heavy	Pneumatic				Light	Medium	Heavy	Pneumatic	
YD	Premium Snap-In Wiper with O.D. Exclusion Technology					8-5	J	Performance Canned Wiper					8-17
SHD	Industrial Snap-In Wiper					8-6	AY	Premium Double-Lip Wiper					8-19
SHX	Performance Snap-In Wiper with O.D. Exclusion Technology					8-7	H / 8600	Performance Double-Lip Wiper					8-21
SH959	AN-Style Snap-In Wiper					8-11	K	Industrial Snap-In Wiper					8-27
SX959	Performance AN-Style Wiper with O.D. Exclusion Technology					8-12	AD	PTFE Wiper Seal					8-30
AH	Premium Double-Lip Canned Wiper					8-15	SG	Metal Scraper					8-36



09/01/07



# Wiper Decision Tree

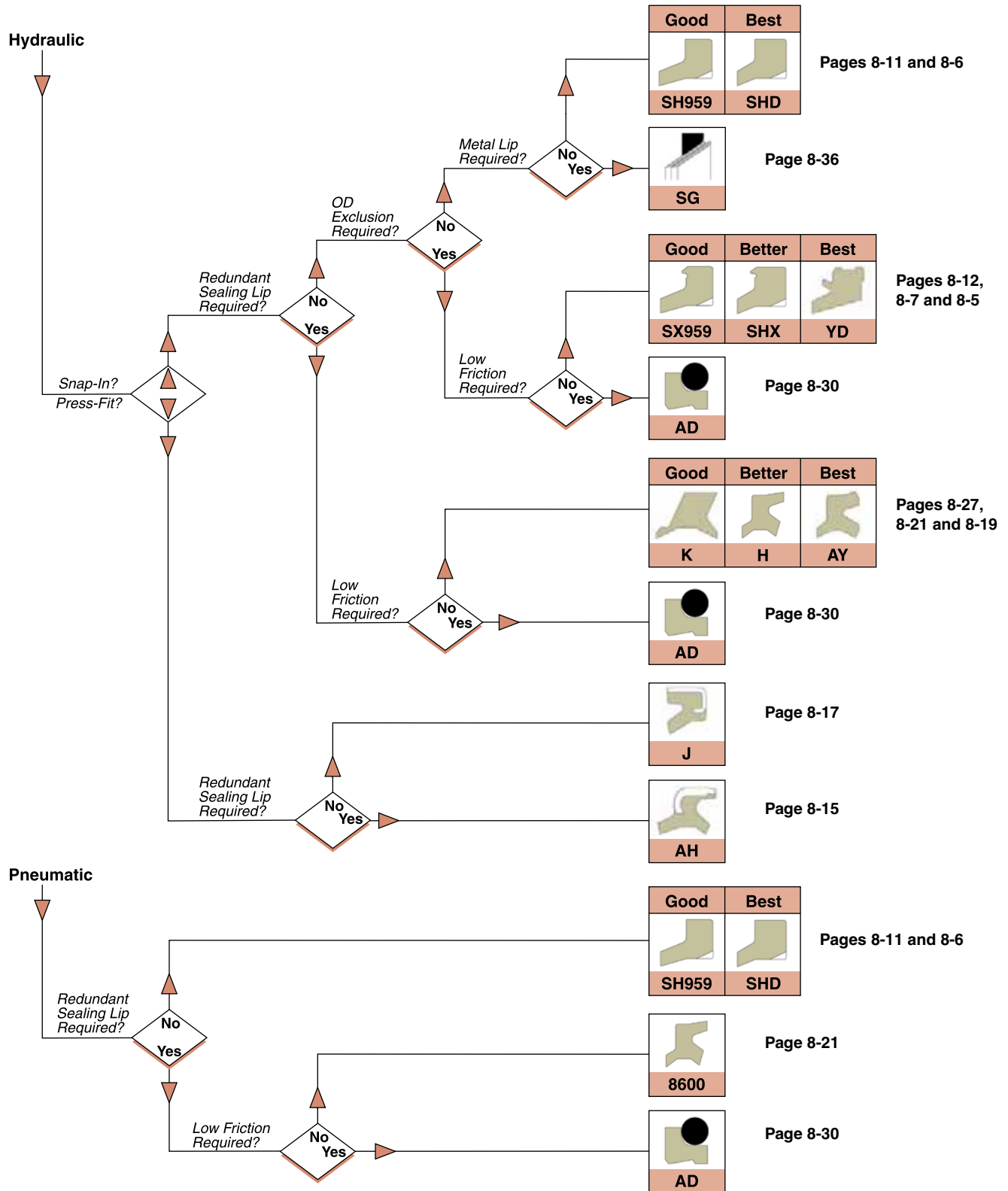

**Note:** Decision Tree is for Profile geometry only. Please consult pages 8-5 through 8-40 for proper material selection.



# Wiper YD Profile

Catalog EPS 5370/USA



## YD Profile, Premium Snap-in Wiper with O.D. Exclusion Technology

The YD wiper is the premier design among high performance, snap-in excluders. Featuring a secondary O.D. lip which seals against the shoulder region of the gland, the YD prevents water and other contaminants from entering around the static side of the wiper. For ultimate performance, the YD also incorporates an aggressive, knife-trimmed wiping lip to ensure maximum exclusion along the rod. A true zero-radius lip provides the most effective wiping action available.

### Technical Data

Standard Materials*	Temperature Range	Surface Speed
P4300A90	-65°F to 275°F (-54° to 135°C)	<1.6 ft/s (0.5 m/s)

**\*Alternate Materials:** For applications that may require an alternate material, please contact your local Parker Seal representative.

### Part Number Nomenclature —YD Profile

Table 8-2. YD Profile — Inch

<b>4</b>	<b>3</b>	<b>0</b>	<b>0</b>	<b>YD</b>	<b>0</b>	<b>1</b>	<b>5</b>	<b>0</b>	<b>0</b>
Seal Compound 4-Digit Material Code Example: 4300 = 90A Resilon HT Polyurethane				Profile	Nominal Rod Diameter (x1000) Example: 1.500 x 1000 = 01500				



YD Cross-Section

### Gland Dimensions — YD Profile

YD gland dimensions are provided in Table 8-5 on page 8-8.

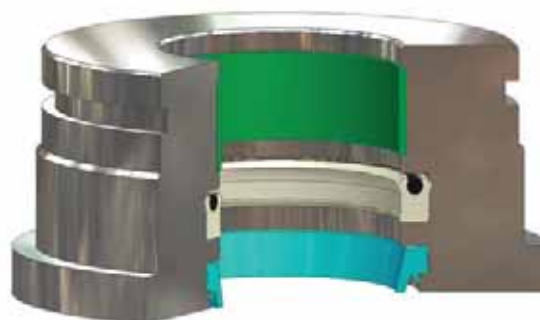

YD installed in Rod Gland



09/01/07

# Wiper SHD Profile



## SHD Profile, Industrial Snap-In Wiper

Parker SHD wipers are an outstanding choice for light and medium duty hydraulic and pneumatic applications. The slotted heel design prevents pressure traps from forming between the rod seal and wiper. Broad tooling availability, up to 30", makes the SHD a good choice for large rod diameters. The snap-in design is oversized for a snug fit and excellent stability. This makes the SHD a great all-round wiper in an economical package.

### Technical Data

Standard Materials*	Temperature Range	Surface Speed
P4615A90	-65°F to 200°F (-54°C to 93°C)	<1.6 f/s (0.5 m/s)
P5065A88	-70°F to 200°F (-57°C to 93°C)	<1.6 f/s (0.5 m/s)
N4263A90	-20°F to 275°F (-29°C to 135°C)	<3.3 f/s (1.0 m/s)
V4208A90	-5°F to 400°F (-21°C to 204°C)	<3.3 f/s (1.0 m/s)
E4207A90	-65°F to 300°F (-54°F to 149°C)	<3.3 f/s (1.0 m/s)

**\*Alternate Materials:** For applications that may require an alternate material, please contact your local Parker Seal representative.

### Part Number Nomenclature — SHD Profile

Table 8-3. SHD Profile — Inch

4	2	6	3	SHD	0	1	0	0	0
└──────────┘				└──┘	└──────────┘				
Seal Compound				Profile	Nominal Rod Diameter (x1000)				
4-Digit Material Code					Example: 1.000 x 1000 = 01000				
Example: 4263 = Nitroxile									



SHD Cross-Section

### Gland Dimensions — SHD Profile

SHD gland dimensions are provided in Table 8-5 on page 8-8.

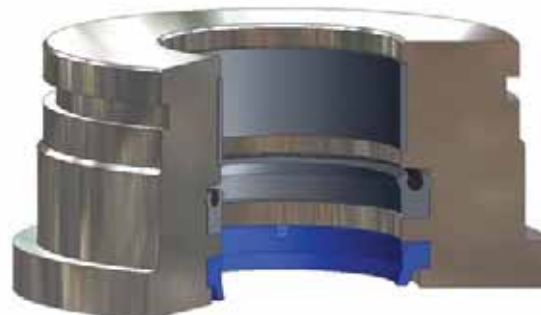

SHD installed in Rod Gland

09/01/07

# Wiper SHX Profile

Catalog EPS 5370/USA



## SHX Profile, Performance Snap-In Wiper with O.D. exclusion technology

Parker SHX wipers offer an improvement over standard D-style wipers by adding O.D. exclusion technology that prevents water and other contamination from entering the system from the static side of the groove. This profile is ideal for applications where the rod is positioned vertically and could allow moisture to collect in the wiper gland. SHX wipers retrofit industry standard D wiper grooves, making the upgrade process simple and economical.

### Technical Data

Standard Materials*	Temperature Range	Surface Speed
P4615A90	-65°F to 200°F (-54°C to 93°C)	<1.6 ft/s (0.5 m/s)
P5065A88	-70°F to 200°F (-57°C to 93°C)	<1.6 ft/s (0.5 m/s)

**\*Alternate Materials:** For applications that may require an alternate material, please contact your local Parker Seal representative.

### Part Number Nomenclature — SHX Profile

Table 8-4. SHX Profile — Inch

<b>5</b>	<b>0</b>	<b>6</b>	<b>5</b>	<b>SHX</b>	<b>0</b>	<b>1</b>	<b>3</b>	<b>7</b>	<b>5</b>
Seal Compound 4-Digit Material Code Example: 5065 = Polyurethane (Low Temperature Urethane)				Profile	Nominal Rod Diameter (x1000) Example: 1.375 x 1000 = 01375				



### Gland Dimensions — SHX Profile

SHX gland dimensions are provided in Table 8-5 on page 8-8.

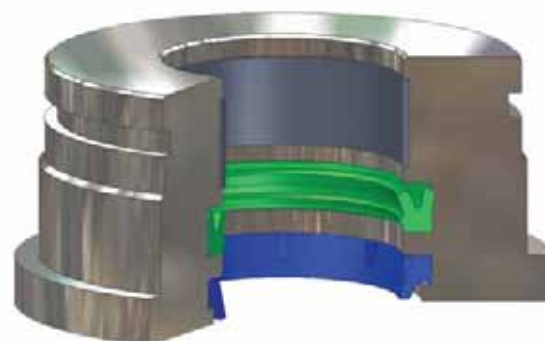

SHX installed in Rod Gland

8

09/01/07

# Wiper YD, SHD and SHX Gland Dimensions

Catalog EPS 5370/USA

## Gland Dimensions — YD, SHD and SHX Profiles

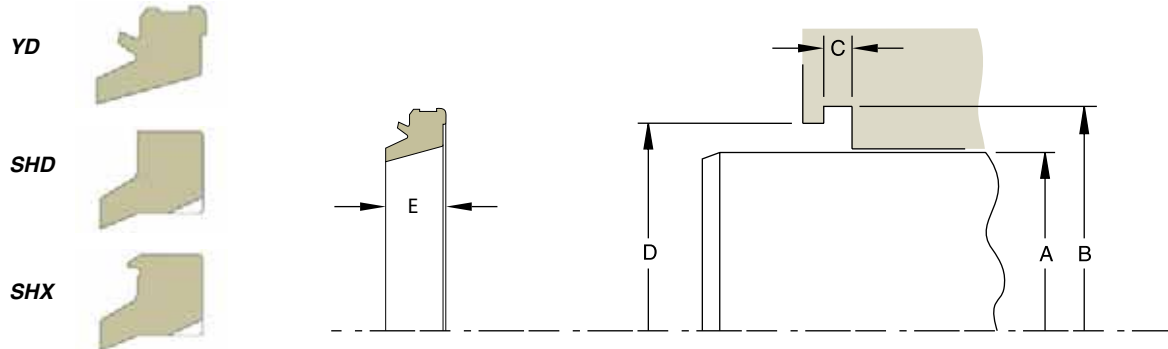

Please refer to Engineering Section 2, page 2-8 for surface finish and additional hardware considerations.

Table 8-5. YD, SHD and SHX Gland Dimensions — Inch

A Rod Diameter	B Groove Diameter	C Groove Width	D Shoulder Diameter	E Max. Wiper Axial Width	Compound Codes (X = Standard Offering)									Part Number				
					SHD					SHX		YD	Compound Code	Profile	Rod Size			
					4615	5065	4263	4208	4207	4615	5065	4300						
<b>+.000/-0.002</b>	<b>+.006/-0.000</b>	<b>+.004/-0.000</b>	<b>+.005/-0.000</b>															
0.250	0.497	0.124	0.410	0.210	x	x			x					XXXX	xxx		00250	
0.312	0.560	0.124	0.475	0.210	x	x	x		x					XXXX	xxx		00312	
0.375	0.622	0.124	0.535	0.210	x	x			x					XXXX	xxx		00375	
0.437	0.685	0.124	0.600	0.210	x	x								XXXX	xxx		00437	
0.500	0.747	0.124	0.660	0.210	x	x	x	x		x	x			XXXX	xxx		00500	
0.562	0.810	0.124	0.725	0.210	x	x		x						XXXX	xxx		00562	
0.625	0.872	0.124	0.785	0.210	x	x		x		x	x			XXXX	xxx		00625	
0.687	0.935	0.124	0.850	0.210	x	x								XXXX	xxx		00687	
0.750	1.122	0.187	0.995	0.305	x	x	x	x	x	x	x	x		XXXX	xxx		00750	
0.875	1.247	0.187	1.120	0.305	x	x				x	x			XXXX	xxx		00875	
1.000	1.372	0.187	1.245	0.305	x	x		x		x	x	x		XXXX	xxx		01000	
1.125	1.497	0.187	1.370	0.305	x	x				x	x	x		XXXX	xxx		01125	
1.187	1.560	0.187	1.435	0.305	x	x								XXXX	xxx		01187	
1.250	1.622	0.187	1.495	0.305	x	x				x	x	x		XXXX	xxx		01250	
1.375	1.747	0.187	1.620	0.305	x	x	x			x	x	x		XXXX	xxx		01375	
1.500	1.872	0.187	1.745	0.305	x	x				x	x	x		XXXX	xxx		01500	
1.625	1.997	0.187	1.870	0.305	x	x	x			x	x	x		XXXX	xxx		01625	
1.750	2.122	0.187	1.995	0.305	x	x	x	x	x	x	x	x		XXXX	xxx		01750	
1.875	2.247	0.187	2.120	0.305	x	x	x			x	x	x		XXXX	xxx		01875	
2.000	2.497	0.249	2.327	0.395	x	x	x		x	x	x	x		XXXX	xxx		02000	
<b>+.000/-0.003</b>	<b>+.006/-0.000</b>	<b>+.004/-0.000</b>	<b>+.005/-0.000</b>															
2.125	2.622	0.249	2.452	0.395	x	x		x		x	x			XXXX	xxx		02125	
2.250	2.747	0.249	2.577	0.395	x	x	x	x		x	x	x		XXXX	xxx		02250	
2.375	2.872	0.249	2.702	0.395	x	x		x						XXXX	xxx		02375	
2.500	2.997	0.249	2.827	0.395	x	x	x			x	x	x		XXXX	xxx		02500	
2.625	3.122	0.249	2.952	0.395	x	x	x	x				x		XXXX	xxx		02625	

For custom groove calculations, see Appendix C.

09/01/07

**Table 8-5. YD, SHD and SHX Gland Dimensions — Inch (Continued)**

A Rod Diameter	B Groove Diameter	C Groove Width	D Shoulder Diameter	E Max. Wiper Axial Width	Compound Codes (X = Standard Offering)									Part Number			
					SHD					SHX		YD	Compound Code	Profile	Rod Size		
					4615	5065	4263	4208	4207	4615	5065	4300					
<b>+.000/-0.003</b>	<b>+.006/-0.000</b>	<b>+.004/-0.000</b>	<b>+.005/-0.000</b>														
2.750	3.247	0.249	3.077	0.395	x	x	x	x					x	XXXX	xxx	02750	
2.875	3.372	0.249	3.202	0.395	x	x	x	x					x	XXXX	xxx	02875	
3.000	3.497	0.249	3.327	0.395	x	x		x		x	x		x	XXXX	xxx	03000	
3.125	3.622	0.249	3.452	0.395	x	x								XXXX	xxx	03125	
3.250	3.747	0.249	3.577	0.395	x	x	x						x	XXXX	xxx	03250	
3.375	3.872	0.249	3.702	0.395	x	x		x						XXXX	xxx	03375	
3.500	3.997	0.249	3.827	0.395	x	x	x	x					x	XXXX	xxx	03500	
3.625	4.122	0.249	3.952	0.395	x	x	x							XXXX	xxx	03625	
3.750	4.247	0.249	4.077	0.395	x	x	x	x						XXXX	xxx	03750	
3.875	4.372	0.249	4.202	0.395	x	x	x	x						XXXX	xxx	03875	
4.000	4.497	0.249	4.327	0.395	x	x	x	x	x	x	x			XXXX	xxx	04000	
4.125	4.622	0.249	4.452	0.395			x							XXXX	xxx	04125	
4.250	4.747	0.249	4.577	0.395	x	x	x	x	x				x	XXXX	xxx	04250	
4.375	4.872	0.249	4.702	0.395	x	x								XXXX	xxx	04375	
4.500	5.247	0.374	4.993	0.585	x	x	x	x	x				x	XXXX	xxx	04500	
4.625	5.372	0.374	5.118	0.585			x	x						XXXX	xxx	04625	
4.750	5.497	0.374	5.243	0.585	x	x	x							XXXX	xxx	04750	
4.875	5.622	0.374	5.368	0.585	x	x	x							XXXX	xxx	04875	
5.000	5.747	0.374	5.493	0.585	x	x	x	x					x	XXXX	xxx	05000	
5.250	5.997	0.374	5.743	0.585	x	x	x							XXXX	xxx	05250	
5.375	6.122	0.374	5.868	0.585	x	x								XXXX	xxx	05375	
5.500	6.247	0.374	5.993	0.585	x	x	x						x	XXXX	xxx	05500	
5.625	6.372	0.374	6.118	0.585	x	x								XXXX	xxx	05625	
5.750	6.497	0.374	6.243	0.585				x						XXXX	xxx	05750	
5.875	6.622	0.374	6.368	0.585	x	x								XXXX	xxx	05875	
6.000	6.747	0.374	6.493	0.585	x	x	x	x	x					XXXX	xxx	06000	
<b>+.000/-0.004</b>	<b>+.006/-0.000</b>	<b>+.004/-0.000</b>	<b>+.005/-0.000</b>														
6.250	6.997	0.374	6.743	0.585			x	x	x					XXXX	xxx	06250	
6.500	7.247	0.374	6.993	0.585	x	x	x							XXXX	xxx	06500	
6.750	7.497	0.374	7.243	0.585			x							XXXX	xxx	06750	
7.000	7.747	0.374	7.493	0.585	x	x		x						XXXX	xxx	07000	
7.250	7.997	0.374	7.743	0.585			x	x						XXXX	xxx	07250	
7.500	8.247	0.374	7.993	0.585			x	x						XXXX	xxx	07500	
7.750	8.497	0.374	8.243	0.585										XXXX	xxx	07750	
8.000	8.747	0.374	8.493	0.585	x	x	x	x						XXXX	xxx	08000	
8.250	8.997	0.374	8.743	0.585				x						XXXX	xxx	08250	
8.500	9.247	0.374	8.993	0.585	x	x								XXXX	xxx	08500	
<b>+.000/-0.005</b>	<b>+.006/-0.000</b>	<b>+.004/-0.000</b>	<b>+.005/-0.000</b>														
8.750	9.497	0.374	9.243	0.585			x							XXXX	xxx	08750	
9.000	9.747	0.374	9.493	0.585	x	x							x	XXXX	xxx	09000	
10.000	10.997	0.499	10.659	0.775	x	x								XXXX	xxx	10000	
10.750	11.747	0.499	11.409	0.775										XXXX	xxx	10625	
11.000	11.997	0.499	11.659	0.775	x	x								XXXX	xxx	11000	
12.000	12.997	0.499	12.659	0.775	x	x								XXXX	xxx	12000	
12.500	13.497	0.499	13.159	0.775	x	x								XXXX	xxx	12500	
14.000	14.997	0.499	14.659	0.775	x	x		x						XXXX	xxx	14000	



For custom groove calculations, see Appendix C.



**YD, SHD and SHX Profiles**

**Table 8-5. YD, SHD and SHX Gland Dimensions — Inch (Continued)**

A Rod Diameter	B Groove Diameter	C Groove Width	D Shoulder Diameter	E Max. Wiper Axial Width	Compound Codes (X = Standard Offering)									Part Number		
					SHD					SHX		YD	Compound Code	Profile	Rod Size	
					4615	5065	4263	4208	4207	4615	5065	4300				
<b>+0.000/-0.005</b>	<b>+0.006/-0.000</b>	<b>+0.004/-0.000</b>	<b>+0.005/-0.000</b>													
14.750	15.747	0.499	15.409	0.775	x									XXXX	xxx	14750
15.000	15.997	0.499	15.659	0.775	x									XXXX	xxx	15000
16.000	16.997	0.499	16.659	0.775	x	x								XXXX	xxx	16000
20.000	20.997	0.499	20.659	0.775	x	x								XXXX	xxx	20000
30.000	30.997	0.499	30.659	0.775	x	x								XXXX	xxx	30000

For custom groove calculations, see Appendix C.

NOTE: For sizes larger than those shown in the table, please contact your local Parker Seal representative.



# Wiper SH959 Profile

Catalog EPS 5370/USA



## SH959 Profile, AN-Style Snap-In Wiper

Parker SH959 wipers are AN style excluders designed to ensure proper fit with all MS-28776 (MS-33675) dash size grooves. The slotted heel design prevents pressure traps from forming between the rod seal and wiper. This profile of wiper requires very little radial or axial space. This is why they are ideal in light to medium duty hydraulic and pneumatic applications where such space constraints are present.

### Technical Data

Standard Materials*	Temperature Range	Surface Speed
P4615A90	-65°F to 200°F (-54°C to 93°C)	<1.6 ft/s (0.5 m/s)
P5065A88	-70°F to 200°F (-57°C to 93°C)	<1.6 ft/s (0.5 m/s)
N4263A90	-20°F to 275°F (-29°C to 135°C)	<3.3 ft/s (1.0 m/s)
V4208A90	-5°F to 400°F (-21°C to 204°C)	<3.3 ft/s (1.0 m/s)
E4207A90	-65°F to 300°F (-54°C to 149°C)	<3.3 ft/s (1.0 m/s)

**\*Alternate Materials:** For applications that may require an alternate material, please contact your local Parker Seal representative.

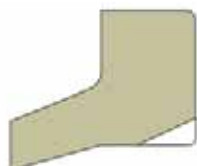

SH959 Cross-Section

### Part Number Nomenclature — SH959 Profile

Table 8-6. SH959 Profile — Inch

4	2	6	3	SH959	-	2	1
└───┬───┬───┬───┘				└───┘	-	└───┬───┘	
Seal Compound				Profile		959 Dash Size	
4-Digit Material Code						Example:	
Example: 4263 = Nitroxile						21 = 2.000" Rod Diameter	



### Gland Dimensions — SH959 Profile

SH959 gland dimensions are provided in Table 8-8 on page 8-13.

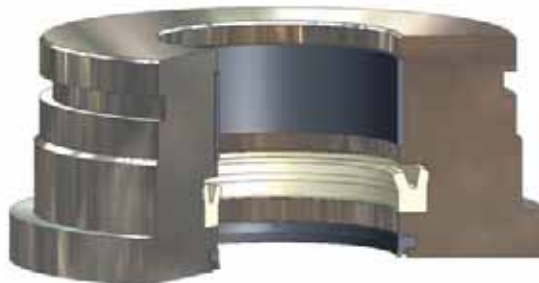

SH959 installed in Rod Gland

09/01/07

# Wiper SX959 Profile

Catalog EPS 5370/USA



## SX959 Profile, Performance AN-Style Wiper with O.D. exclusion technology

Parker's SX959 profile takes AN wipers to a new level by adding O.D. exclusion technology, while still retrofitting MS-28776 (MS-33675) dash size grooves. SX959 wipers offer the same compact size advantages as the SH959, while also improving contaminant exclusion in light to medium duty hydraulic and pneumatic applications.

### Technical Data

Standard Materials*	Temperature Range	Surface Speed
P4615A90	-65°F to 200°F (-54°C to 93°C)	<1.6 ft/s (0.5 m/s)
P5065A88	-70°F to 200°F (-57°C to 93°C)	<1.6 ft/s (0.5 m/s)

\***Alternate Materials:** For applications that may require an alternate material, please contact your local Parker Seal representative.

### Part Number Nomenclature — SX959 Profile

Table 8-7. SX959 Profile — Inch

5	0	6	5	SX959	-	1	1
└──────────┘				└──┘		└──┘	
Seal Compound 4-Digit Material Code Example: 5065 = Polyurethane (Low Temperature Urethane)				Profile		959 Dash Size Example: 11 = 1.125" Rod Diameter	



SX Cross-Section

### Gland Dimensions — SX959 Profile

SX959 gland dimensions are provided in Table 8-8 on page 8-13.

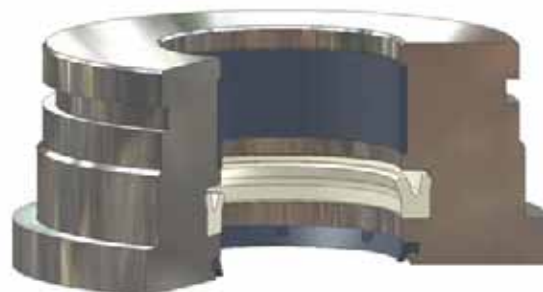

SX959 installed in Rod Gland

09/01/07

# Wiper SH959 and SX959 Gland Dimensions

Catalog EPS 5370/USA

## Gland Dimensions — SH959 and SX959 Profiles

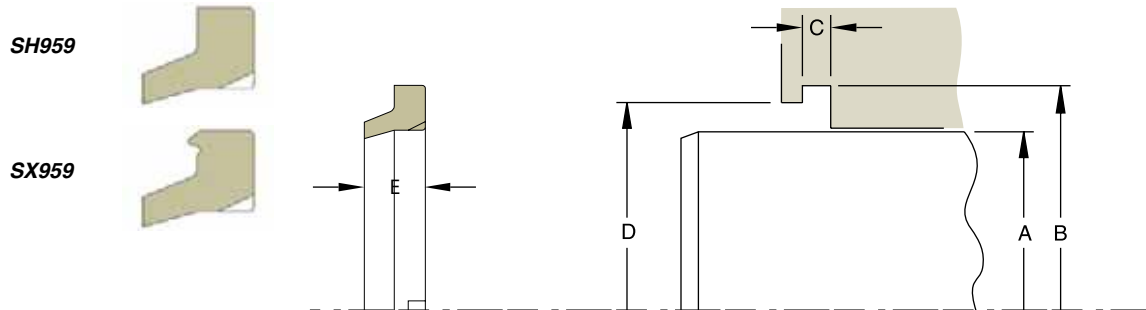

Please refer to Engineering Section 2, page 2-8 for surface finish and additional hardware considerations.

Table 8-8. SH959 and SX959 Gland Dimensions — Inch

Dash Size	A Rod Diameter	B Groove Diameter	C Groove Width	D Shoulder Diameter	E Max. Wiper Axial Width	Compound Code (X = Standard Offering)						Part Number					
						SH959			SX959			Compound Code	Profile				
						4615	5065	4263	4208	4207	4615				5065		
	<b>+0.000/-0.002</b>	<b>+0.004/-0.000</b>	<b>+0.003/-0.003</b>	<b>+0.005/-0.000</b>													
-1	0.500	0.760	0.107	0.647	0.187	x	x	x	x	x	x	x	XXXX	xxxxx	959-01		
-2	0.562	0.823	0.107	0.710	0.187	x	x						XXXX	xxxxx	959-02		
-3	0.625	0.885	0.107	0.772	0.187	x	x	x	x		x	x	XXXX	xxxxx	959-03		
-4	0.687	0.948	0.107	0.834	0.187	x	x	x					XXXX	xxxxx	959-04		
-5	0.750	1.010	0.107	0.897	0.187	x	x		x	x	x	x	XXXX	xxxxx	959-05		
-6	0.812	1.084	0.107	0.960	0.187	x	x			x			XXXX	xxxxx	959-06		
-7	0.875	1.147	0.107	1.023	0.187	x	x	x	x		x	x	XXXX	xxxxx	959-07		
-9	1.000	1.272	0.107	1.148	0.187	x	x	x	x	x	x	x	XXXX	xxxxx	959-09		
-10	1.062	1.334	0.107	1.210	0.187	x	x	x		x			XXXX	xxxxx	959-10		
-11	1.125	1.397	0.107	1.273	0.187	x	x	x	x		x	x	XXXX	xxxxx	959-11		
-12	1.187	1.459	0.107	1.335	0.187	x	x						XXXX	xxxxx	959-12		
-13	1.250	1.522	0.107	1.398	0.187	x	x			x	x	x	XXXX	xxxxx	959-13		
-14	1.312	1.614	0.107	1.480	0.187	x	x	x	x	x			XXXX	xxxxx	959-14		
-15	1.375	1.677	0.107	1.542	0.187	x	x				x	x	XXXX	xxxxx	959-15		
-16	1.437	1.739	0.107	1.605	0.187	x	x						XXXX	xxxxx	959-16		
-17	1.500	1.802	0.107	1.668	0.187	x	x		x		x	x	XXXX	xxxxx	959-17		
-M	1.562	1.865	0.107	1.731	0.187	x	x						XXXX	xxxxx	959-M		
-18	1.625	1.927	0.107	1.793	0.187	x	x				x	x	XXXX	xxxxx	959-18		
-19	1.750	2.052	0.107	1.918	0.187	x	x		x		x	x	XXXX	xxxxx	959-19		
-A	1.812	2.115	0.107	1.981	0.187	x	x						XXXX	xxxxx	959-A		
-20	1.875	2.117	0.107	2.043	0.187	x	x				x	x	XXXX	xxxxx	959-20		
-21	2.000	2.302	0.107	2.178	0.187	x	x	x	x	x	x	x	XXXX	xxxxx	959-21		
	<b>+0.000/-0.003</b>	<b>+0.004/-0.000</b>	<b>+0.003/-0.003</b>	<b>+0.005/-0.000</b>													
-22	2.125	2.427	0.107	2.303	0.187	x	x		x		x	x	XXXX	xxxxx	959-22		
-23	2.250	2.552	0.107	2.428	0.187	x	x				x	x	XXXX	xxxxx	959-23		
-24	2.375	2.677	0.107	2.553	0.187	x	x		x				XXXX	xxxxx	959-24		
-25	2.500	2.802	0.107	2.678	0.187	x	x		x	x	x	x	XXXX	xxxxx	959-25		

For custom groove calculations, see Appendix C.

8

09/01/07



**SH959 and SX959 Profile**

**Table 8-8. SH959 and SX959 Gland Dimensions — Inch (Continued)**

Dash Size	A Rod Diameter	B Groove Diameter	C Groove Width	D Shoulder Diameter	E Max. Wiper Axial Width	Compound Code (X = Standard Offering)						Part Number					
						SH959					SX959		Compound Code	Profile			
						4615	5065	4263	4208	4207	4615	5065					
	<b>+0.000/-0.003</b>	<b>+0.004/-0.000</b>	<b>+0.003/-0.003</b>	<b>+0.005/-0.000</b>													
-26	2.625	2.989	0.122	2.834	0.211	x	x						XXXX	xxxxx	959-26		
-27	2.750	3.114	0.122	2.959	0.211	x	x	x	x		x	x	XXXX	xxxxx	959-27		
-28	2.875	3.239	0.122	3.084	0.211	x	x						XXXX	xxxxx	959-28		
-29	3.000	3.364	0.122	3.209	0.211	x	x		x	x	x	x	XXXX	xxxxx	959-29		
-30	3.125	3.489	0.122	3.334	0.211	x	x						XXXX	xxxxx	959-30		
-31	3.250	3.614	0.122	3.459	0.211	x	x						XXXX	xxxxx	959-31		
-32	3.375	3.739	0.122	3.584	0.211	x	x						XXXX	xxxxx	959-32		
-33	3.500	3.864	0.122	3.709	0.211	x	x		x	x			XXXX	xxxxx	959-33		
-34	3.625	3.989	0.122	3.834	0.211				x				XXXX	xxxxx	959-34		
-35	3.750	4.114	0.122	3.959	0.211	x	x						XXXX	xxxxx	959-35		
-36	3.875	4.239	0.122	4.084	0.211	x	x						XXXX	xxxxx	959-36		
-37	4.000	4.427	0.138	4.240	0.238	x	x		x	x	x	x	XXXX	xxxxx	959-37		
-38	4.125	4.552	0.138	4.365	0.238	x	x						XXXX	xxxxx	959-38		
-39	4.250	4.677	0.138	4.490	0.238	x	x		x				XXXX	xxxxx	959-39		
-41	4.500	4.927	0.138	4.740	0.238	x	x						XXXX	xxxxx	959-41		
-42	4.625	5.052	0.138	4.865	0.238	x	x						XXXX	xxxxx	959-42		
-43	4.750	5.177	0.138	4.990	0.238	x	x						XXXX	xxxxx	959-43		
-45	5.000	5.427	0.138	5.240	0.238	x	x	x	x	x			XXXX	xxxxx	959-45		
-47	5.250	5.677	0.138	5.490	0.238	x	x						XXXX	xxxxx	959-47		
-49	5.500	5.927	0.138	5.740	0.238	x	x						XXXX	xxxxx	959-49		
-51	5.750	6.239	0.154	6.022	0.264	x	x						XXXX	xxxxx	959-51		
-53	6.000	6.489	0.154	6.272	0.264	x	x		x				XXXX	xxxxx	959-53		
	<b>+0.000/-0.004</b>	<b>+0.005/-0.000</b>	<b>+0.003/-0.003</b>	<b>+0.005/-0.000</b>													
-55	6.500	6.989	0.154	6.772	0.264	x	x						XXXX	xxxxx	959-55		
-56	6.750	7.239	0.154	7.022	0.264	x	x						XXXX	xxxxx	959-56		
-57	7.000	7.489	0.154	7.272	0.264	x	x			x			XXXX	xxxxx	959-57		
-L	7.375	7.864	0.154	7.647	0.264	x	x						XXXX	xxxxx	959-L		
-59	7.500	7.989	0.154	7.772	0.264	x	x						XXXX	xxxxx	959-59		
-62	8.500	8.989	0.154	8.772	0.264	x	x						XXXX	xxxxx	959-62		
	<b>+0.000/-0.005</b>	<b>+0.005/-0.000</b>	<b>+0.003/-0.003</b>	<b>+0.010/-0.000</b>													
-63	9.000	9.489	0.154	9.272	0.264	x	x		x				XXXX	xxxxx	959-63		
-64	9.500	9.989	0.154	9.772	0.264	x	x						XXXX	xxxxx	959-64		
-65	10.000	10.489	0.154	10.272	0.264	x	x						XXXX	xxxxx	959-65		
-66	10.500	10.989	0.154	10.772	0.264	x	x						XXXX	xxxxx	959-66		
-FF	11.250	11.739	0.169	11.522	0.289	x	x						XXXX	xxxxx	959-FF		
-68	11.500	11.989	0.169	11.772	0.289	x	x						XXXX	xxxxx	959-68		
-69	12.000	12.489	0.169	12.272	0.289	x	x						XXXX	xxxxx	959-69		
-70	12.500	12.989	0.169	12.772	0.289	x	x						XXXX	xxxxx	959-70		
-K	13.750	14.239	0.169	14.022	0.289	x	x						XXXX	xxxxx	959-K		
-77	14.000	14.489	0.169	14.272	0.289	x	x						XXXX	xxxxx	959-77		
-Q	14.250	14.739	0.169	14.522	0.289	x	x						XXXX	xxxxx	959-Q		

For custom groove calculations, see Appendix C.

NOTE: For sizes larger than those shown in the table, please contact your local Parker Seal representative.



# Wiper AH Profile

Catalog EPS 5370/USA

## AH Profile, Premium Double-Lip Canned Wiper



Parker's AH profile is the ultimate metal-clad excluder for heavy duty hydraulic applications. Press-fit installation prevents O.D. contamination while the additional sealing lip works in conjunction with Parker rod seals to provide redundant sealing for leakage reduction. An aggressive wiping lip, facing the environment, ensures the utmost performance in contaminant exclusion along the rod.

**IMPORTANT:** When using the AH wiper in conjunction with other rod seals, it is important to select a rod seal profile that enables pressure relief of fluid into the system, otherwise a pressure trap may form between the wiper and rod seal. Suggested rod profiles are the BT, BS, and B3 u-cups.

## Technical Data

Standard Materials*	Temperature Range	Surface Speed
P4300A90	-65°F to 275°F (-54°C to 135°C)	<1.6 ft/s (0.5 m/s)
P4700A90	-65° to 200°F (-54°C to 93°C)	<1.6 ft/s (0.5 m/s)
P4615A90	-65°F to 200°F (-54°C to 93°C)	<1.6 ft/s (0.5 m/s)

**\*Alternate Materials:** For applications that may require an alternate material, please contact your local Parker Seal representative.



AH Cross-Section

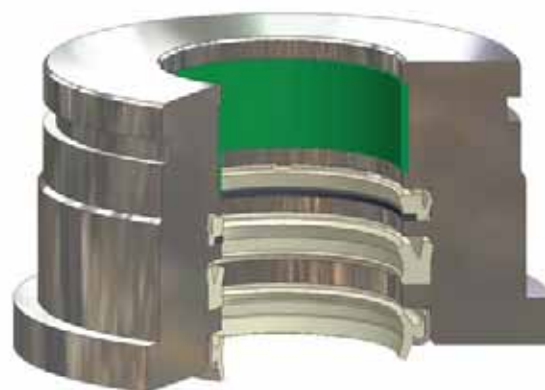

AH installed in Rod Gland

8

09/01/07

## AH Profile

### Part Number Nomenclature — AH Profile

Table 8-9. AH Profile — Inch

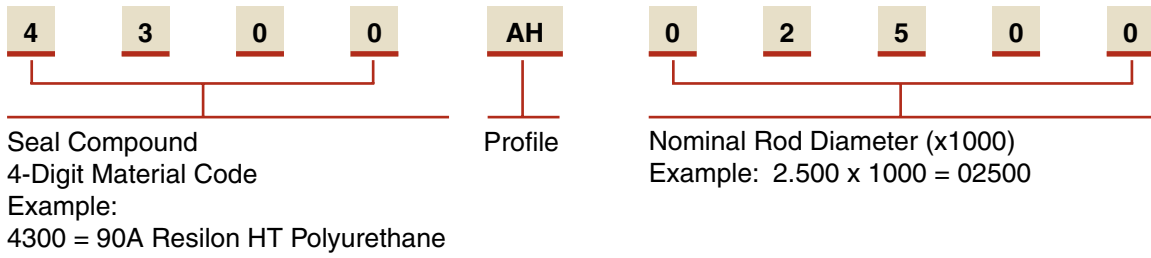

### Gland Dimensions — AH Profile

AH gland dimensions are provided in Table 8-11 on page 8-18.

# Wiper J Profile

Catalog EPS 5370/USA



## J Profile, Performance Canned Wiper

The press-fit installation of Parker's J wiper guards against O.D. contamination and results in simple counter-bore groove machining. The wiping lip on the J wiper is very aggressive, eliminating the ingestion of dust, mud and moisture from harsh work areas. J wipers are ideal for medium and heavy duty hydraulic cylinders in the most demanding applications.

### Technical Data

Standard Materials*	Temperature Range	Surface Speed
P4300A90	-65°F to 275°F (-54°C to 135°C)	<1.6 ft/s (0.5 m/s)
P4700A90	-65° to 200°F (-54°C to 93°C)	<1.6 ft/s (0.5 m/s)
P4615A90	-65°F to 200°F (-54°C to 93°C)	<1.6 ft/s (0.5 m/s)

**\*Alternate Materials:** For applications that may require an alternate material, please contact your local Parker Seal representative.

### Part Number Nomenclature — J Profile

Table 8-10. J Profile — Inch

4	7	0	0	J	0	3	0	0	0
└──────────┬──────────┘				└──┘	└──────────┬──────────┬──────────┬──────────┘				
Seal Compound 4-Digit Material Code Example: 4700 = Polyurethane				Profile	Nominal Rod Diameter (x1000) Example: 3.00 x 1000 = 03000				



J Cross-Section

### Gland Dimensions — J Profile

J gland dimensions are provided in Table 8-11 on page 8-18.

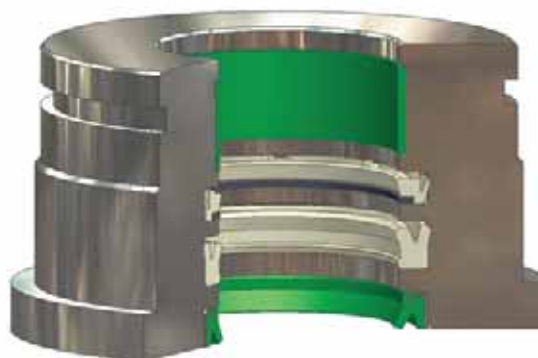

J installed in Rod Gland

8

09/01/07



# Wiper AH and J Gland Dimensions

Catalog EPS 5370/USA

## Gland Dimensions — AH and J Profiles

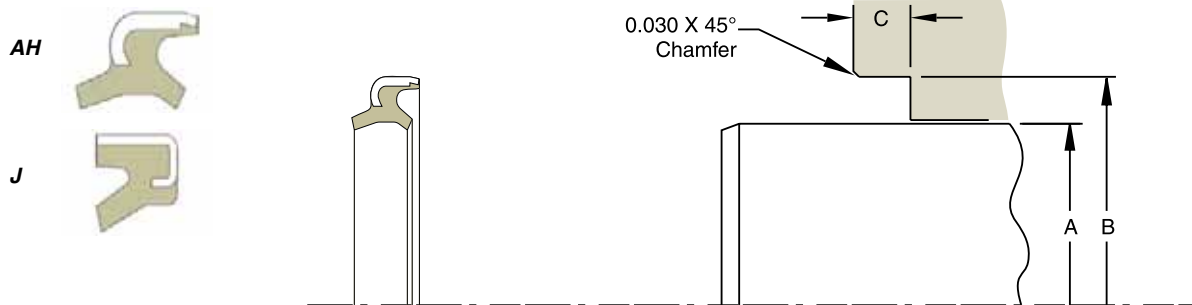

Please refer to Engineering Section 2, page 2-8 for surface finish and additional hardware considerations.

Table 8-11. AH and J Gland Dimensions — Inch

A Rod Diameter	B Groove Diameter	C Groove Width	Profile Code*		Part Number		
			AH	J	Compound Code	Profile Code	Rod Size
+0.000/-0.002	+0.001/-0.001	+0.015/-0.000					
0.500	1.000	0.250		x	XXXX	xx	00500
0.625	1.125	0.312	x	x	XXXX	xx	00625
0.750	1.250	0.312	x	x	XXXX	xx	00750
0.875	1.375	0.312	x	x	XXXX	xx	00875
1.000	1.500	0.312	x	x	XXXX	xx	01000
1.125	1.625	0.312	x	x	XXXX	xx	01125
1.250	1.750	0.312	x	x	XXXX	xx	01250
1.375	1.875	0.312	x	x	XXXX	xx	01375
1.500	2.000	0.312	x	x	XXXX	xx	01500
1.625	2.125	0.312	x	x	XXXX	xx	01625
1.750	2.250	0.312	x	x	XXXX	xx	01750
1.875	2.375	0.312	x	x	XXXX	xx	01875
2.000	2.500	0.312	x	x	XXXX	xx	02000
+0.000/-0.003	+0.001/-0.001	+0.015/-0.000					
2.125	2.625	0.312	x	x	XXXX	xx	02125
2.250	2.750	0.312	x	x	XXXX	xx	02250
2.375	2.875	0.312		x	XXXX	xx	02375
2.500	3.000	0.312	x	x	XXXX	xx	02500
2.625	3.125	0.312		x	XXXX	xx	02625
2.750	3.250	0.312	x	x	XXXX	xx	02750
2.875	3.375	0.312			XXXX	xx	02875
3.000	3.500	0.312	x	x	XXXX	xx	03000

\*X = Standard Offering  
For custom groove calculations, see Appendix C.

A Rod Diameter	B Groove Diameter	C Groove Width	Profile Code*		Part Number		
			AH	J	Compound Code	Profile Code	Rod Size
+0.000/-0.003	+0.001/-0.001	+0.015/-0.000					
3.250	3.875	0.312		x	XXXX	xx	03250
3.500	4.125	0.312		x	XXXX	xx	03500
3.750	4.375	0.312		x	XXXX	xx	03750
4.000	4.625	0.312	x	x	XXXX	xx	04000
4.250	4.875	0.312		x	XXXX	xx	04250
4.500	5.125	0.312		x	XXXX	xx	04500
4.750	5.375	0.312			XXXX	xx	04750
5.000	5.625	0.312		x	XXXX	xx	05000
5.250	5.875	0.312			XXXX	xx	05250
5.500	6.125	0.375		x	XXXX	xx	05500
5.750	6.375	0.375			XXXX	xx	05750
6.000	6.625	0.375			XXXX	xx	06000
+0.000/-0.004	+0.001/-0.001	+0.015/-0.015					
6.250	6.875	0.375			XXXX	xx	06250
6.500	7.125	0.375			XXXX	xx	06500
6.750	7.375	0.375			XXXX	xx	06750
7.000	7.625	0.375			XXXX	xx	07000
7.250	7.875	0.375			XXXX	xx	07250
7.500	8.125	0.375			XXXX	xx	07500
7.750	8.375	0.375			XXXX	xx	07750
8.000	8.625	0.375			XXXX	xx	08000

\*X = Standard Offering  
For custom groove calculations, see Appendix C.

NOTE: For sizes larger than those shown in the table, please contact your local Parker Seal representative.

09/01/07



# Wiper AY Profile

Catalog EPS 5370/USA

## AY Profile, Premium Double-Lipped Wiper



The AY profile can be used as a heavy to light duty wiper. When used in high pressure applications in conjunction with the proper Parker rod seals, the AY compliments the sealing system by providing an additional beveled sealing lip, yielding excellent film-breaking and the driest rod sealing available. These dual acting features also enable it to be used by itself in low pressure applications as both the rod seal and the wiper. Knife-trimmed sealing lips ensure the best possible film breaking.

**IMPORTANT:** When using the AY wiper in conjunction with other rod seals, it is important to select a rod seal profile that enables pressure relief of fluid into the system, otherwise a pressure trap may form between the wiper and rod seal. Suggested rod profiles are the BT, BS, and B3 u-cups.

## Technical Data

Standard Materials*	Temperature Range	Surface Speed
P4300A90	-65°F to 275°F (-54°C to 135°C)	<1.6 ft/s (0.5 m/s)
P4301A90	-35°F to 225°F (-37°C to 107°C)	<1.6 ft/s (0.5 m/s)
P4700A90	-65° to 200°F (-54°C to 93°C)	<1.6 ft/s (0.5 m/s)

\***Alternate Materials:** For applications that may require an alternate material, please contact your local Parker Seal representative.



AY Cross-Section

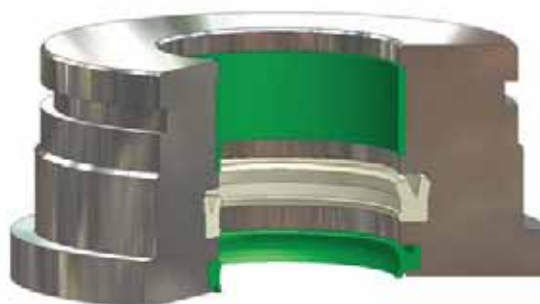

AY installed in Rod Gland

8

09/01/07

## AY Profile

### Part Number Nomenclature — AY Profile

Table 8-12. AY Profile — Inch

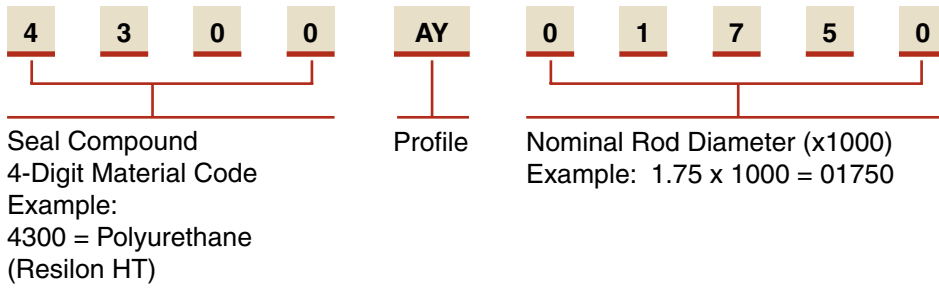

### Part Number Nomenclature — AY Profile

Table 8-13. AY Profile — Inch

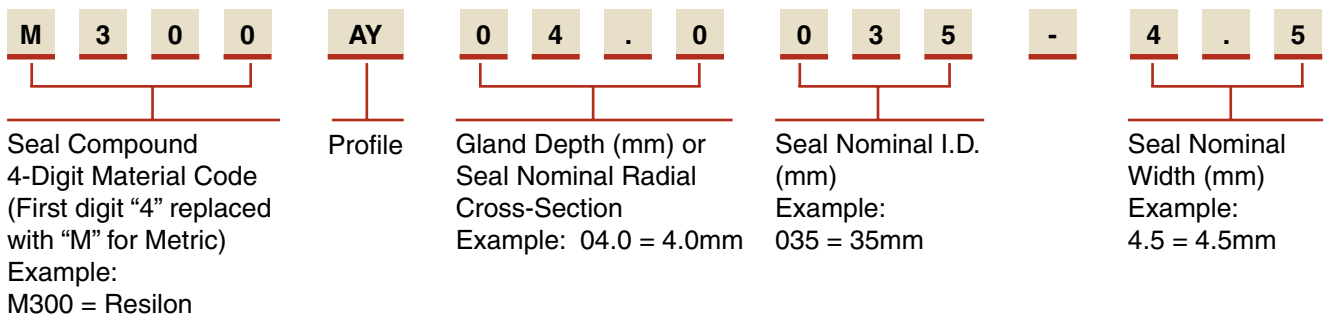

### Gland Dimensions — AY Profile — Inch

AY gland dimensions are provided in Table 8-15 on page 8-23.

### 8 Gland Dimensions — AY Profile — Metric

AY gland dimensions for metric sizes are provided in Table 8-16 on page 8-26.

# Wiper H and 8600 Profiles

Catalog EPS 5370/USA

## H and 8600 Profiles, Performance Double-Lip Wiper



Parker's H and 8600 style wipers are double-lip excluders sharing identical geometries for combining the actions of rod sealing and wiping. H wipers, available in plastic compounds, are intended for medium pressure hydraulic applications as a redundant rod seal or for low pressure systems as the sole rod seal and wiper. 8600 wipers, available in rubber compounds, are typically used for pneumatic cylinders where lower friction is required. As with the H wiper, the 8600 can be used in tandem with another rod seal or by itself as a dual-acting sealing/wiping unit.

**IMPORTANT: When using H and 8600 wipers in conjunction with other rod seals, it is important to select a rod seal profile that enables pressure relief of fluid into the system, otherwise a pressure trap may form between the wiper and rod seal. Suggested rod profiles are the BT, BS, B3, 8400, 8500 and E5 u-cups.**

## Technical Data

Standard Materials*	Temperature Range	Surface Speed
P4615A90 (H)	-65°F to 200°F (-54°C to 93°C)	<1.6 ft/s (0.5 m/s)
P5065A88 (H)	-70°F to 200°F (-57°C to 93°C)	<1.6 ft/s (0.5 m/s)
N4181A80 (8600)	-40°F to 250°F (-40°C to 121°C)	<3.3 ft/s (1.0 m/s)

**\*Alternate Materials:** For applications that may require an alternate material, please contact your local Parker Seal representative.



*H / 8600 Cross-Section*

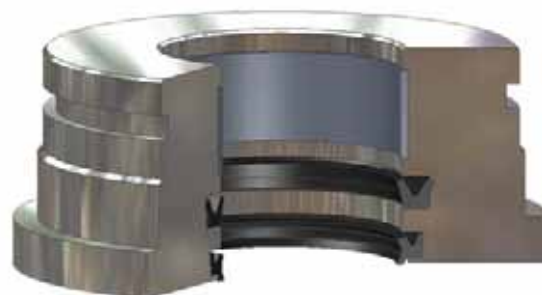

*H and 8600 installed in Rod Gland*



09/01/07

## H and 8600 Profiles

### Part Number Nomenclature — H and 8600 Profiles

Table 8-14. H and 8600 Profiles — Inch

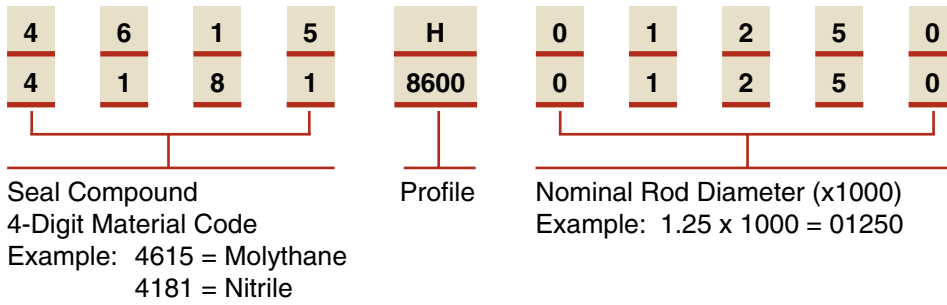

### Gland Dimensions — H and 8600 Profiles

H and 8600 gland dimensions are provided in Table 8-15 on page 8-23.

# Wiper AY, H and 8600 Gland Dimensions

Catalog EPS 5370/USA

## Gland Dimensions — AY, H and 8600 Profiles — Inch

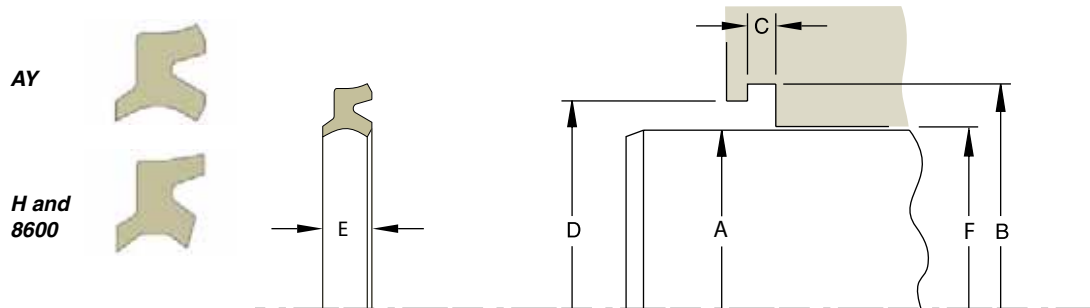

Please refer to Engineering Section 2, page 2-8 for surface finish and additional hardware considerations.

Table 8-15. AY, H and 8600 Gland Dimensions — Inch

A Rod Diameter	B Groove Diameter	C Groove Width	D Shoulder Diameter	E Max. Wiper Axial Width	F Throat Diameter	Profile Code (X = Standard Offering)			Part Number		
						AY	H	8600	Compound Code	Profile	Rod Size
+0.000/-0.002	+0.002/-0.000	+0.005/-0.000	+0.002/-0.000		+0.002/-0.000						
0.250	0.552	0.203	0.370	0.245	0.251		x	x	XXXX	xxxx	00250
0.312	0.615	0.203	0.432	0.245	0.313		x	x	XXXX	xxxx	00312
0.375	0.677	0.203	0.495	0.245	0.376		x	x	XXXX	xxxx	00375
0.437	0.740	0.203	0.557	0.245	0.438		x	x	XXXX	xxxx	00437
0.500	0.802	0.203	0.620	0.245	0.501	x	x	x	XXXX	xxxx	00500
0.562	0.865	0.203	0.682	0.245	0.563		x	x	XXXX	xxxx	00562
0.625	0.927	0.203	0.745	0.245	0.626	x	x	x	XXXX	xxxx	00625
0.687	0.990	0.203	0.808	0.245	0.688		x	x	XXXX	xxxx	00687
0.750	1.052	0.203	0.870	0.245	0.751	x	x	x	XXXX	xxxx	00750
0.812	1.177	0.218	0.947	0.275	0.813		x		XXXX	xxxx	00812
0.875	1.240	0.218	1.010	0.275	0.876	x	x	x	XXXX	xxxx	00875
0.937	1.302	0.218	1.072	0.275	0.938		x		XXXX	xxxx	00937
1.000	1.365	0.218	1.135	0.275	1.001	x	x	x	XXXX	xxxx	01000
1.062	1.427	0.218	1.197	0.275	1.063		x		XXXX	xxxx	01062
1.125	1.490	0.218	1.260	0.275	1.126	x	x	x	XXXX	xxxx	01125
1.187	1.552	0.218	1.322	0.275	1.188		x		XXXX	xxxx	01187
1.250	1.615	0.218	1.385	0.275	1.251	x	x	x	XXXX	xxxx	01250
1.312	1.702	0.218	1.447	0.275	1.313		x	x	XXXX	xxxx	01312
1.375	1.740	0.218	1.510	0.275	1.376	x	x	x	XXXX	xxxx	01375
1.437	1.802	0.218	1.572	0.275	1.438		x		XXXX	xxxx	01437
1.500	1.865	0.218	1.635	0.275	1.501	x	x	x	XXXX	xxxx	01500
1.562	1.927	0.218	1.697	0.275	1.563		x		XXXX	xxxx	01562
1.625	1.990	0.218	1.760	0.275	1.626	x	x	x	XXXX	xxxx	01625
1.687	2.052	0.218	1.823	0.275	1.688		x		XXXX	xxxx	01687
1.750	2.115	0.218	1.885	0.275	1.751	x	x	x	XXXX	xxxx	01750
1.812	2.177	0.218	1.947	0.275	1.813		x		XXXX	xxxx	01812
1.875	2.240	0.218	2.010	0.275	1.876	x	x	x	XXXX	xxxx	01875
1.937	2.302	0.218	2.072	0.275	1.938		x		XXXX	xxxx	01937
2.000	2.365	0.218	2.135	0.275	2.001	x	x	x	XXXX	xxxx	02000

For custom groove calculations, see Appendix C.



09/01/07



**AY, H and 8600 Profiles**

**Table 8-15. AY, H and 8600 Gland Dimensions — Inch (Continued)**

A Rod Diameter	B Groove Diameter	C Groove Width	D Shoulder Diameter	E Max. Wiper Axial Width	F Throat Diameter	Profile Code (X = Standard Offering)			Part Number		
						AY	H	8600	Compound Code	Profile	Rod Size
<b>+.000/-0.003</b>	<b>+.003/-0.000</b>	<b>+.005/-0.000</b>	<b>+.003/-0.000</b>		<b>+.003/-0.000</b>						
2.062	2.427	0.218	2.197	0.275	2.063		x		XXXX	xxxx	02062
2.125	2.490	0.218	2.260	0.275	2.126	x	x	x	XXXX	xxxx	02125
2.187	2.683	0.281	2.323	0.351	2.188		x		XXXX	xxxx	02187
2.250	2.745	0.281	2.385	0.351	2.251	x	x	x	XXXX	xxxx	02250
2.312	2.807	0.281	2.447	0.351	2.313		x		XXXX	xxxx	02312
2.375	2.870	0.281	2.510	0.351	2.376		x		XXXX	xxxx	02375
2.437	2.932	0.281	2.572	0.351	2.438		x	x	XXXX	xxxx	02437
2.500	2.995	0.281	2.635	0.351	2.501	x	x	x	XXXX	xxxx	02500
2.562	3.057	0.281	2.697	0.351	2.563		x		XXXX	xxxx	02562
2.625	3.120	0.281	2.760	0.351	2.626		x		XXXX	xxxx	02625
2.687	3.183	0.281	2.823	0.351	2.688		x		XXXX	xxxx	02687
2.750	3.245	0.281	2.885	0.351	2.751	x	x	x	XXXX	xxxx	02750
2.812	3.307	0.281	2.947	0.351	2.813		x		XXXX	xxxx	02812
2.875	3.370	0.281	3.010	0.351	2.876		x	x	XXXX	xxxx	02875
2.937	3.433	0.281	3.073	0.351	2.938		x	x	XXXX	xxxx	02937
3.000	3.495	0.281	3.135	0.351	3.001	x	x	x	XXXX	xxxx	03000
3.125	3.620	0.281	3.260	0.351	3.126		x		XXXX	xxxx	03125
3.250	3.745	0.281	3.385	0.351	3.251		x	x	XXXX	xxxx	03250
3.375	3.870	0.281	3.510	0.351	3.376		x		XXXX	xxxx	03375
3.437	3.932	0.281	3.572	0.351	3.438			x	XXXX	xxxx	03437
3.500	3.995	0.281	3.635	0.351	3.501		x	x	XXXX	xxxx	03500
3.625	4.120	0.281	3.760	0.351	3.626		x		XXXX	xxxx	03625
3.750	4.245	0.281	3.885	0.351	3.751		x	x	XXXX	xxxx	03750
3.875	4.370	0.281	4.010	0.351	3.876		x		XXXX	xxxx	03875
4.000	4.495	0.281	4.135	0.351	4.001	x	x	x	XXXX	xxxx	04000
4.125	4.620	0.281	4.260	0.351	4.126		x		XXXX	xxxx	04125
4.250	4.745	0.281	4.385	0.351	4.251		x	x	XXXX	xxxx	04250
4.375	4.870	0.281	4.510	0.351	4.376		x		XXXX	xxxx	04375
4.500	4.995	0.281	4.635	0.351	4.501		x	x	XXXX	xxxx	04500
4.625	5.120	0.281	4.760	0.351	4.626		x		XXXX	xxxx	04625
4.750	5.245	0.281	4.885	0.351	4.751		x		XXXX	xxxx	04750
4.875	5.370	0.281	5.010	0.351	4.876		x		XXXX	xxxx	04875
5.000	5.495	0.281	5.135	0.351	5.001		x	x	XXXX	xxxx	05000
5.125	5.620	0.281	5.260	0.351	5.126		x		XXXX	xxxx	05125
5.187	5.682	0.281	5.322	0.351	5.188			x	XXXX	xxxx	05187
5.250	5.745	0.281	5.385	0.351	5.251		x		XXXX	xxxx	05250
5.375	5.870	0.281	5.510	0.351	5.376		x		XXXX	xxxx	05375
5.500	5.995	0.281	5.635	0.351	5.501		x	x	XXXX	xxxx	05500
5.625	6.120	0.281	5.760	0.351	5.626		x		XXXX	xxxx	05625
5.750	6.245	0.281	5.885	0.351	5.751		x		XXXX	xxxx	05750
5.875	6.370	0.281	6.010	0.351	5.876		x		XXXX	xxxx	05875
6.000	6.495	0.281	6.135	0.351	6.001		x	x	XXXX	xxxx	06000

For custom groove calculations, see Appendix C.



Table 8-15. AY, H and 8600 Gland Dimensions — Inch (Continued)

A Rod Diameter	B Groove Diameter	C Groove Width	D Shoulder Diameter	E Max. Wiper Axial Width	F Throat Diameter	Profile Code (X = Standard Offering)			Part Number		
						AY	H	8600	Compound Code	Profile	Rod Size
<b>+ .000/- .004</b>	<b>+ .003/- .000</b>	<b>+ .005/- .000</b>	<b>+ .003/- .000</b>		<b>+ .003/- .000</b>						
6.250	6.745	0.281	6.385	0.351	6.251		x		XXXX	xxxx	06250
6.375	6.870	0.281	6.510	0.351	6.376			x	XXXX	xxxx	06375
6.500	6.995	0.281	6.635	0.351	6.501		x		XXXX	xxxx	06500
6.750	7.245	0.281	6.885	0.351	6.751		x		XXXX	xxxx	06750
7.000	7.495	0.281	7.135	0.351	7.001		x	x	XXXX	xxxx	07000
7.250	7.745	0.281	7.385	0.351	7.251		x	x	XXXX	xxxx	07250
7.500	7.995	0.281	7.635	0.351	7.501		x		XXXX	xxxx	07500
7.750	8.245	0.281	7.885	0.351	7.751		x		XXXX	xxxx	07750
8.000	8.495	0.281	8.135	0.351	8.001		x	x	XXXX	xxxx	08000
8.250	8.745	0.281	8.385	0.351	8.251		x		XXXX	xxxx	08250
8.500	8.995	0.281	8.635	0.351	8.501		x	x	XXXX	xxxx	08500
<b>+ .000/- .005</b>	<b>+ .003/- .000</b>	<b>+ .005/- .000</b>	<b>+ .003/- .000</b>		<b>+ .003/- .000</b>						
8.750	9.245	0.281	8.885	0.351	8.751		x		XXXX	xxxx	08750
9.000	9.495	0.281	9.135	0.351	9.001		x	x	XXXX	xxxx	09000
9.250	9.745	0.281	9.385	0.351	9.251		x		XXXX	xxxx	09250
9.500	9.995	0.281	9.635	0.351	9.501		x		XXXX	xxxx	09500
9.750	10.245	0.281	9.885	0.351	9.751		x	x	XXXX	xxxx	09750
10.000	10.495	0.281	10.135	0.351	10.001		x	x	XXXX	xxxx	10000

For custom groove calculations, see Appendix C.

NOTE: For sizes larger than those shown in the table, please contact your local Parker Seal representative.

**Gland Dimensions — AY, H and 8600 Profiles — Metric**

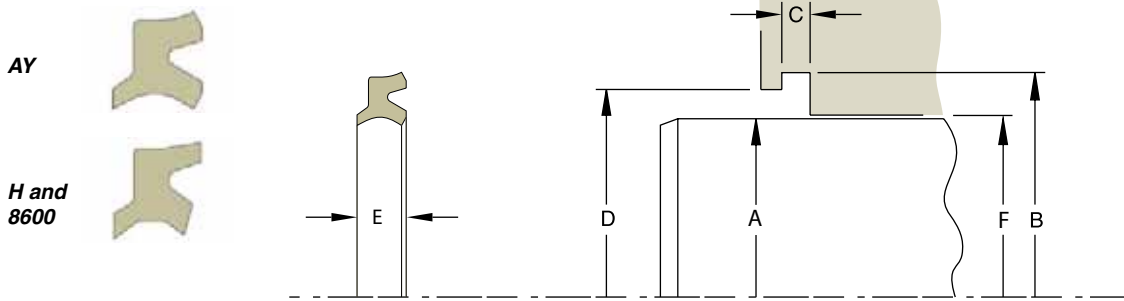

Please refer to Engineering Section 2, page 2-8 for surface finish and additional hardware considerations.

**Table 8-16. AY Gland Dimensions — Metric**

A Rod Diameter	B Groove Diameter	C Groove Width	D Shoulder Diameter	E Max. Wiper Axial Width	F Throat Diameter	Part Number		
f7	H11	+0.2/-0.0	H11		H8	Compound Code	Profile	
For ISO tolerances refer to Appendix F.								
10.0	16.0	4.0	12.5	4.8	10.03	M300	AY	03.0010-3.6
20.0	26.0	4.0	22.5	4.8	20.03	M300	AY	03.0020-3.6
25.0	31.0	4.0	27.5	4.8	25.03	M300	AY	03.0025-3.6
30.0	38.0	5.0	33.0	5.8	30.03	M300	AY	04.0030-4.5
32.0	40.0	5.0	35.0	5.8	32.03	M300	AY	04.0032-4.5
35.0	43.0	5.0	38.0	5.8	35.03	M300	AY	04.0035-4.5
36.0	44.0	5.0	39.0	5.8	36.03	M300	AY	04.0036-4.5
40.0	48.0	5.0	43.0	5.8	40.03	M300	AY	04.0040-4.5
42.0	50.0	5.0	45.0	5.8	42.03	M300	AY	04.0042-4.5
45.0	53.0	5.0	48.0	5.8	45.03	M300	AY	04.0045-4.5
50.0	58.0	5.5	53.0	7.0	50.03	M300	AY	04.0050-5.0
55.0	65.0	5.0	58.0	5.8	55.03	M300	AY	05.0055-4.5
55.0	65.0	6.0	58.0	6.8	55.03	M300	AY	05.0055-5.3
60.0	70.0	6.0	63.0	6.8	60.03	M300	AY	05.0060-5.3
64.0	74.0	6.0	67.0	6.8	64.03	M300	AY	05.0064-5.3
64.0	74.0	6.0	67.0	6.8	64.03	M300	AY	05.0064-5.3
70.0	80.0	6.0	73.0	6.8	70.03	M300	AY	05.0070-5.3
75.0	85.0	6.0	78.0	6.8	75.03	M300	AY	05.0075-5.3
100.0	110.0	6.0	104.0	6.8	100.03	M300	AY	05.0100-5.3
120.0	135.0	8.5	124.0	9.5	120.03	M300	AY	07.5120-7.5

# Wiper K Profile

Catalog EPS 5370/USA



## K Profile, Industrial Snap-In Wiper

K wipers offer a unique, light-load contact lip on both the sealing and wiping lips, making these excluders suitable for light duty industrial hydraulic applications. They are most commonly used in conjunction with Parker rod seals to provide a redundant film-breaking lip.

### Technical Data

Standard Materials*	Temperature Range	Surface Speed
P4615A90	-65°F to 200°F (-54C to 93°C)	<1.6 ft/s (0.5 m/s)

**\*Alternate Materials:** For applications that may require an alternate material, please contact your local Parker Seal representative.

### Part Number Nomenclature — K Profile

Table 8-17. K Profile — Inch

4	6	1	5	K	0	0	7	5	0
└──────────┘				└──┘	└──────────┘				
Seal Compound 4-Digit Material Code Example: 4615 = Molythane				Profile	Nominal Rod Diameter (x1000) Example: 0.750 x 1000 = 00750				



*K Cross-Section*



*K installed in Rod Gland*

8

09/01/07

**K Profile**

**Gland Dimensions — K Profile**

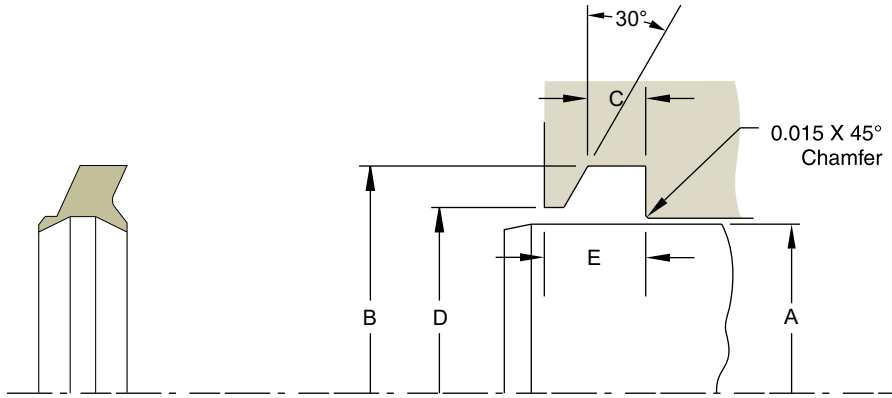

Please refer to Engineering Section 2, page 2-8 for surface finish and additional hardware considerations.

**Table 8-18. K Gland Dimensions — Inch**

A Rod Diameter	B Groove Diameter	C Groove Width	D Shoulder Diameter	E Max. Wiper Axial Width	Part Number
<b>+0.000/-0.002</b>	<b>+0.005/-0.000</b>	<b>+0.005/-0.000</b>	<b>+0.005/-0.000</b>		
0.500	0.760	0.155	0.625	0.315	4615K00500
0.562	0.822	0.155	0.687	0.315	4615K00562
0.625	0.885	0.155	0.750	0.315	4615K00625
0.687	0.947	0.155	0.812	0.315	4615K00687
0.750	1.135	0.195	0.832	0.366	4615K00750
0.812	1.197	0.195	0.894	0.366	4615K00812
0.875	1.260	0.195	0.957	0.366	4615K00875
0.937	1.322	0.195	1.019	0.366	4615K00937
1.000	1.385	0.195	1.082	0.366	4615K01000
1.062	1.447	0.195	1.144	0.366	4615K01062
1.125	1.510	0.195	1.207	0.366	4615K01125
1.187	1.572	0.195	1.269	0.366	4615K01187
1.250	1.635	0.195	1.332	0.366	4615K01250
1.312	1.697	0.195	1.394	0.366	4615K01312
1.375	1.760	0.195	1.457	0.366	4615K01375
1.437	1.822	0.195	1.519	0.366	4615K01437
1.500	1.885	0.195	1.582	0.366	4615K01500
1.562	1.947	0.195	1.644	0.366	4615K01562
1.625	2.010	0.195	1.707	0.366	4615K01625
1.687	2.072	0.195	1.769	0.366	4615K01687
1.750	2.135	0.195	1.832	0.366	4615K01750
1.812	2.197	0.195	1.894	0.366	4615K01812
1.875	2.260	0.195	1.957	0.366	4615K01875
1.937	2.322	0.195	2.019	0.366	4615K01937
2.000	2.385	0.195	2.082	0.366	4615K02000
<b>+0.000/-0.003</b>	<b>+0.005/-0.000</b>	<b>+0.005/-0.000</b>	<b>+0.005/-0.000</b>		
2.125	2.510	0.195	2.207	0.366	4615K02125
2.250	2.760	0.255	2.407	0.483	4615K02250
2.375	2.885	0.255	2.532	0.483	4615K02375
2.500	3.010	0.255	2.657	0.483	4615K02500
2.625	3.135	0.255	2.782	0.483	4615K02625
2.750	3.260	0.255	2.907	0.483	4615K02750
2.875	3.385	0.255	3.032	0.483	4615K02875

For custom groove calculations, see Appendix C.

Table 8-18. K Gland Dimensions — Inch (Continued)

A Rod Diameter	B Groove Diameter	C Groove Width	D Shoulder Diameter	E Max. Wiper Axial Width	Part Number
<b>+0.000/-0.003</b>	<b>+0.005/-0.000</b>	<b>+0.005/-0.000</b>	<b>+0.005/-0.000</b>		
3.000	3.510	0.255	3.157	0.483	4615K03000
3.125	3.635	0.255	3.282	0.483	4615K03125
3.250	3.760	0.255	3.407	0.483	4615K03250
3.375	3.885	0.255	3.532	0.483	4615K03375
3.500	4.010	0.255	3.657	0.483	4615K03500
3.625	4.135	0.255	3.782	0.483	4615K03625
3.750	4.260	0.255	3.907	0.483	4615K03750
3.875	4.385	0.255	4.032	0.483	4615K03875
4.000	4.510	0.255	4.157	0.483	4615K04000
4.125	4.635	0.255	4.282	0.483	4615K04125
4.250	4.760	0.255	4.407	0.483	4615K04250
4.375	4.885	0.255	4.532	0.483	4615K04375
4.500	5.010	0.255	4.657	0.483	4615K04500
4.625	5.135	0.255	4.782	0.483	4615K04625
4.750	5.260	0.255	4.907	0.483	4615K04750
4.875	5.385	0.255	5.032	0.483	4615K04875
5.000	5.510	0.255	5.157	0.483	4615K05000
5.250	5.760	0.255	5.407	0.483	4615K05250
5.500	6.010	0.255	5.657	0.483	4615K05500
5.750	6.260	0.255	5.907	0.483	4615K05750
6.000	6.510	0.255	6.157	0.483	4615K06000
<b>+0.000/-0.004</b>	<b>+0.005/-0.000</b>	<b>+0.005/-0.000</b>	<b>+0.005/-0.000</b>		
6.250	6.760	0.255	6.407	0.483	4615K06250
6.500	7.010	0.255	6.657	0.483	4615K06500
6.750	7.260	0.255	6.907	0.483	4615K06750
7.000	7.510	0.255	7.157	0.483	4615K07000
7.500	8.010	0.255	7.657	0.483	4615K07500
8.000	8.510	0.255	8.157	0.483	4615K08000
8.500	9.010	0.255	8.657	0.483	4615K08500
<b>+0.000/-0.005</b>	<b>+0.005/-0.000</b>	<b>+0.005/-0.000</b>	<b>+0.005/-0.000</b>		
9.000	9.510	0.255	9.157	0.483	4615K09000
9.500	10.010	0.255	9.657	0.483	4615K09500
10.000	10.510	0.255	10.157	0.483	4615K10000

For custom groove calculations, see Appendix C.

NOTE: For sizes larger than those shown in the table, please contact your local Parker Seal representative.

# Wiper AD Profile

Catalog EPS 5370/USA



## AD Profile, PTFE Wiper Seal

The Parker AD profile is a double acting wiper for use in low to medium duty hydraulic cylinders. It is a two piece design comprised of a filled PTFE cap that is energized by a standard size o-ring. The wiper and seal design of the AD profile assists the primary rod seal in preventing leakage by helping seal fluid in the cylinder when the rod extends. When the cylinder rod retracts, the outside sealing edge prevents contamination from entering the system. Parker's AD profile will retrofit non-Parker wipers of similar design.

The AD profile may be ordered without the energizer. See part number nomenclature.

## Technical Data

### Standard Materials

#### Standard Materials\* Cap

Standard Materials*	Temperature Range	Surface Speed
0401 40% bronze-filled PTFE	-200°F to 575°F -129°C to 302°C	< 5 ft/s (1.5 m/sec)

#### Energizer

A 70A Nitrile	-30°F to 250°F (-34°C to 121°C)
---------------	------------------------------------

**\*Alternate Materials:** For applications that may require an alternate material, please see Section 3 for alternate PTFE (Table 3-4) and energizer (Table 3-5) materials.



Standard AD Cross-Section

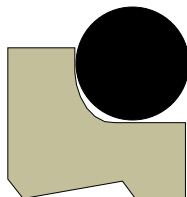

Wide AD Cross-Section

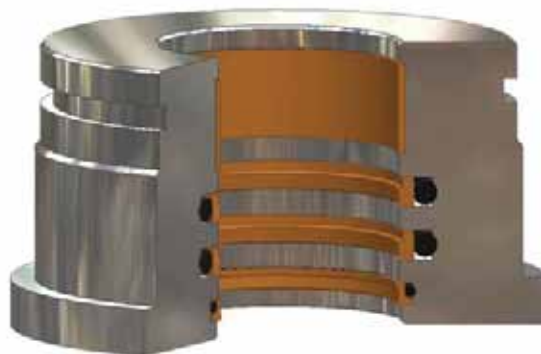

AD installed in Rod Gland

09/01/07

**Part Number Nomenclature — AD Profile**

**Table 8-19. AD Profile — Inch**

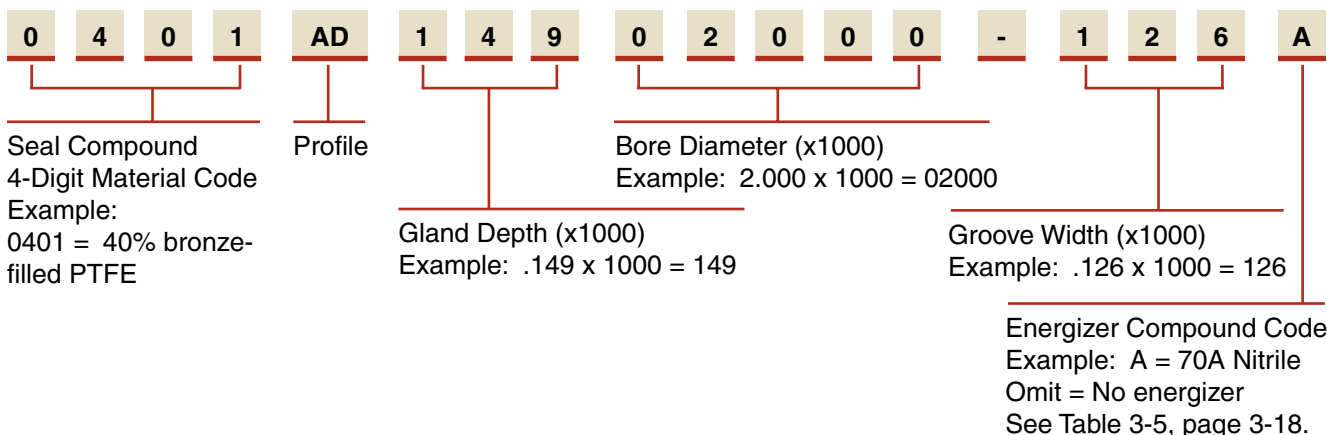

**Gland Dimensions — AD Profile**

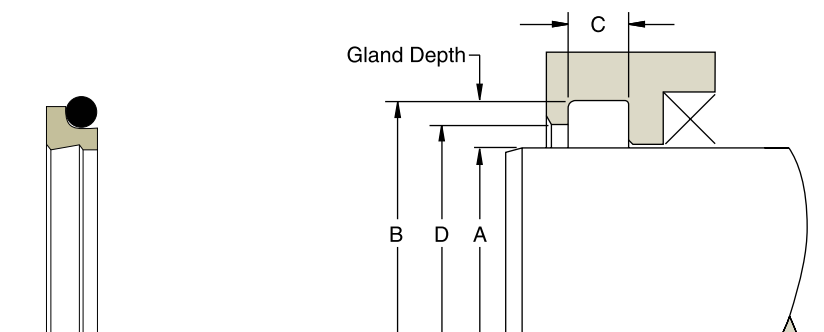

Please refer to  
**Engineering Section  
2, page 2-8 for surface  
finish and additional  
hardware considerations.**

**Table 8-20. AD Gland Dimensions (Standard) — Inch**

A Rod Diameter	B Groove Diameter	C Groove Width	D Shoulder Diameter	O-ring Dash Number	AD Part Number (Standard)
<b>+.000/-.002</b>	<b>+.001/-.000</b>	<b>+.008/-.000</b>	<b>+.003/-.000</b>		
0.250	0.440	0.146	0.310	011	<b>0401AD09500250-146A</b>
0.313	0.503	0.146	0.373	012	<b>0401AD09500313-146A</b>
0.375	0.565	0.146	0.435	013	<b>0401AD09500375-146A</b>
<b>+.000/-.002</b>	<b>+.002/-.000</b>	<b>+.008/-.000</b>	<b>+.004/-.000</b>		
0.438	0.628	0.146	0.498	014	<b>0401AD09500438-146A</b>
0.500	0.690	0.146	0.560	015	<b>0401AD09500500-146A</b>
0.563	0.753	0.146	0.623	016	<b>0401AD09500563-146A</b>
0.625	0.815	0.146	0.685	017	<b>0401AD09500625-146A</b>
0.688	0.878	0.146	0.748	018	<b>0401AD09500688-146A</b>
0.750	0.940	0.146	0.810	019	<b>0401AD09500750-146A</b>
0.813	1.003	0.146	0.873	020	<b>0401AD09500813-146A</b>
0.875	1.065	0.146	0.935	021	<b>0401AD09500875-146A</b>
0.938	1.128	0.146	0.998	022	<b>0401AD09500938-146A</b>
1.000	1.190	0.146	1.060	023	<b>0401AD09501000-146A</b>
<b>+.000/-.002</b>	<b>+.002/-.000</b>	<b>+.008/-.000</b>	<b>+.004/-.000</b>		
0.500	0.770	0.196	0.560	113	<b>0401AD13500500-196A</b>
0.563	0.833	0.196	0.623	114	<b>0401AD13500563-196A</b>
0.625	0.895	0.196	0.685	115	<b>0401AD13500625-196A</b>

For custom groove calculations, see Appendix C.





**AD Profile****Table 8-20. AD Gland Dimensions (Standard) — Inch (Continued)**

A Rod Diameter	B Groove Diameter	C Groove Width	D Shoulder Diameter	O-ring Dash Number	AD Part Number (Standard)
<b>+ .000/- .002</b>	<b>+ .002/- .000</b>	<b>+ .008/- .000</b>	<b>+ .004/- .000</b>		
0.688	0.958	0.196	0.748	116	0401AD13500688-196A
0.750	1.020	0.196	0.810	117	0401AD13500750-196A
0.813	1.083	0.196	0.873	118	0401AD13500813-196A
0.875	1.145	0.196	0.935	119	0401AD13500875-196A
0.938	1.208	0.196	0.998	120	0401AD13500938-196A
1.000	1.270	0.196	1.060	121	0401AD13501000-196A
1.063	1.333	0.196	1.123	122	0401AD13501063-196A
1.125	1.395	0.196	1.185	123	0401AD13501125-196A
1.188	1.458	0.196	1.248	124	0401AD13501188-196A
1.250	1.520	0.196	1.310	125	0401AD13501250-196A
1.313	1.583	0.196	1.373	126	0401AD13501313-196A
1.375	1.645	0.196	1.435	127	0401AD13501375-196A
1.438	1.708	0.196	1.498	128	0401AD13501438-196A
1.500	1.770	0.196	1.560	129	0401AD13501500-196A
1.563	1.833	0.196	1.623	130	0401AD13501563-196A
1.625	1.895	0.196	1.685	131	0401AD13501625-196A
1.688	1.958	0.196	1.748	132	0401AD13501688-196A
1.750	2.020	0.196	1.810	133	0401AD13501750-196A
1.813	2.083	0.196	1.873	134	0401AD13501813-196A
1.875	2.145	0.196	1.935	135	0401AD13501875-196A
1.938	2.208	0.196	1.998	136	0401AD13501938-196A
<b>+ .000/- .003</b>	<b>+ .003/- .000</b>	<b>+ .008/- .000</b>	<b>+ .006/- .000</b>		
2.000	2.270	0.196	2.060	137	0401AD13502000-196A
2.063	2.333	0.196	2.123	138	0401AD13502063-196A
2.125	2.395	0.196	2.185	139	0401AD13502125-196A
2.188	2.458	0.196	2.248	140	0401AD13502188-196A
2.250	2.520	0.196	2.310	141	0401AD13502250-196A
2.375	2.645	0.196	2.435	143	0401AD13502375-196A
2.500	2.770	0.196	2.560	145	0401AD13502500-196A
2.625	2.895	0.196	2.685	147	0401AD13502625-196A
2.750	3.020	0.196	2.810	149	0401AD13502750-196A
2.875	3.145	0.196	2.935	151	0401AD13502875-196A
3.000	3.270	0.196	3.060	151	0401AD13503000-196A
3.125	3.395	0.196	3.185	152	0401AD13503125-196A
3.250	3.520	0.196	3.310	152	0401AD13503250-196A
3.375	3.645	0.196	3.435	153	0401AD13503375-196A
3.500	3.770	0.196	3.560	153	0401AD13503500-196A
3.625	3.895	0.196	3.685	154	0401AD13503625-196A
3.750	4.020	0.196	3.810	154	0401AD13503750-196A
3.875	4.145	0.196	3.935	155	0401AD13503875-196A
4.000	4.270	0.196	4.060	155	0401AD13504000-196A
4.125	4.395	0.196	4.185	156	0401AD13504125-196A
4.250	4.520	0.196	4.310	156	0401AD13504250-196A
4.375	4.645	0.196	4.435	157	0401AD13504375-196A
4.500	4.770	0.196	4.560	157	0401AD13504500-196A
4.625	4.895	0.196	4.685	158	0401AD13504625-196A

For custom groove calculations, see Appendix C.

09/01/07



Table 8-20. AD Gland Dimensions (Standard) — Inch (Continued)

A Rod Diameter	B Groove Diameter	C Groove Width	D Shoulder Diameter	O-ring Dash Number	AD Part Number (Standard)
<b>+0.000/-0.004</b>	<b>+0.004/-0.000</b>	<b>+0.008/-0.000</b>	<b>+0.008/-0.000</b>		
4.750	5.020	0.196	4.810	158	0401AD13504750-196A
4.875	5.145	0.196	4.935	159	0401AD13504875-196A
5.000	5.270	0.196	5.060	159	0401AD13505000-196A
5.125	5.395	0.196	5.185	160	0401AD13505125-196A
5.250	5.520	0.196	5.310	160	0401AD13505250-196A
5.375	5.645	0.196	5.435	161	0401AD13505375-196A
5.500	5.770	0.196	5.560	161	0401AD13505500-196A
5.625	5.895	0.196	5.685	162	0401AD13505625-196A
5.750	6.020	0.196	5.810	162	0401AD13505750-196A
6.000	6.270	0.196	6.060	163	0401AD13506000-196A
<b>+0.000/-0.004</b>	<b>+0.004/-0.000</b>	<b>+0.008/-0.000</b>	<b>+0.008/-0.000</b>		
6.000	6.344	0.236	6.060	258	0401AD17206000-236A
6.250	6.594	0.236	6.310	259	0401AD17206250-236A
6.500	6.844	0.236	6.560	260	0401AD17206500-236A
6.750	7.094	0.236	6.810	261	0401AD17206750-236A
7.000	7.344	0.236	7.060	262	0401AD17207000-236A
<b>+0.000/-0.005</b>	<b>+0.005/-0.000</b>	<b>+0.008/-0.000</b>	<b>+0.010/-0.000</b>		
7.250	7.594	0.236	7.310	263	0401AD17207250-236A
7.500	7.844	0.236	7.560	264	0401AD17207500-236A
7.750	8.094	0.236	7.810	265	0401AD17207750-236A
8.000	8.344	0.236	8.060	266	0401AD17208000-236A
8.250	8.594	0.236	8.310	267	0401AD17208250-236A
8.500	8.844	0.236	8.560	268	0401AD17208500-236A
8.750	9.094	0.236	8.810	269	0401AD17208750-236A
9.000	9.344	0.236	9.060	270	0401AD17209000-236A
9.250	9.594	0.236	9.310	271	0401AD17209250-236A
9.500	9.844	0.236	9.560	272	0401AD17209500-236A
9.750	10.094	0.236	9.810	273	0401AD17209750-236A
10.000	10.344	0.236	10.060	274	0401AD17209875-236A
<b>+0.000/-0.005</b>	<b>+0.005/-0.000</b>	<b>+0.008/-0.000</b>	<b>+0.010/-0.000</b>		
10.000	10.480	0.332	10.080	377	0401AD24010000-332A
10.500	10.980	0.332	10.580	378	0401AD24010500-332A
11.000	11.480	0.332	11.080	379	0401AD24011000-332A
11.500	11.980	0.332	11.580	380	0401AD24011500-332A
12.000	12.480	0.332	12.080	381	0401AD24012000-332A
<b>+0.000/-0.006</b>	<b>+0.006/-0.000</b>	<b>+0.008/-0.000</b>	<b>+0.012/-0.000</b>		
12.500	12.980	0.332	12.580	381	0401AD24012500-332A
13.000	13.480	0.332	13.080	382	0401AD24013000-332A
13.500	13.980	0.332	13.580	382	0401AD24013500-332A
14.000	14.480	0.332	14.080	383	0401AD24014000-332A
14.500	14.980	0.332	14.580	383	0401AD24014500-332A
15.000	15.480	0.332	15.080	384	0401AD24015000-332A
15.500	15.980	0.332	15.580	384	0401AD24015500-332A
16.000	16.480	0.332	16.080	385	0401AD24016000-332A
16.500	16.980	0.332	16.580	385	0401AD24016500-332A
17.000	17.480	0.332	17.080	386	0401AD24017000-332A

For custom groove calculations, see Appendix C.

**AD Profile****Table 8-21. AD Gland Dimensions (Wide) — Inch**

A Rod Diameter	B Groove Diameter	C Groove Width	D Shoulder Diameter	O-ring Dash Number	AD Part Number (Wide)
<b>+0.000/-0.002</b>	<b>+0.002/-0.000</b>	<b>+0.008/-0.000</b>	<b>+0.004/-0.000</b>		
1.500	1.846	0.248	1.560	131	0401AD17301500-248A
1.563	1.909	0.248	1.623	132	0401AD17301563-248A
1.625	1.971	0.248	1.685	133	0401AD17301625-248A
1.688	2.034	0.248	1.748	134	0401AD17301688-248A
1.750	2.096	0.248	1.810	135	0401AD17301750-248A
1.813	2.159	0.248	1.873	136	0401AD17301813-248A
1.875	2.221	0.248	1.935	136	0401AD17301875-248A
1.938	2.284	0.248	1.998	137	0401AD17301938-248A
<b>+0.000/-0.003</b>	<b>+0.003/-0.000</b>	<b>+0.008/-0.000</b>	<b>+0.006/-0.000</b>		
2.000	2.346	0.248	2.060	138	0401AD17302000-248A
2.125	2.471	0.248	2.185	140	0401AD17302125-248A
2.250	2.596	0.248	2.310	142	0401AD17302250-248A
2.375	2.721	0.248	2.435	144	0401AD17302375-248A
2.500	2.846	0.248	2.560	146	0401AD17302500-248A
2.625	2.971	0.248	2.685	148	0401AD17302625-248A
<b>+0.000/-0.003</b>	<b>+0.003/-0.000</b>	<b>+0.008/-0.000</b>	<b>+0.006/-0.000</b>		
2.750	3.230	0.319	2.830	234	0401AD24002750-319A
2.875	3.355	0.319	2.955	235	0401AD24002875-319A
3.000	3.480	0.319	3.080	236	0401AD24003000-319A
3.125	3.605	0.319	3.205	237	0401AD24003125-319A
3.250	3.730	0.319	3.330	238	0401AD24003250-319A
3.375	3.855	0.319	3.455	239	0401AD24003375-319A
3.500	3.980	0.319	3.580	240	0401AD24003500-319A
3.625	4.105	0.319	3.705	240	0401AD24003625-319A
3.750	4.230	0.319	3.830	241	0401AD24003750-319A
3.875	4.355	0.319	3.955	242	0401AD24003875-319A
4.000	4.480	0.319	4.080	243	0401AD24004000-319A
4.125	4.605	0.319	4.205	244	0401AD24004125-319A
4.250	4.730	0.319	4.330	245	0401AD24004250-319A
4.375	4.855	0.319	4.455	246	0401AD24004375-319A
4.500	4.980	0.319	4.580	247	0401AD24004500-319A
4.625	5.105	0.319	4.705	248	0401AD24004625-319A
<b>+0.000/-0.004</b>	<b>+0.004/-0.000</b>	<b>+0.008/-0.000</b>	<b>+0.008/-0.000</b>		
4.750	5.230	0.319	4.830	249	0401AD24004750-319A
4.875	5.355	0.319	4.955	250	0401AD24004875-319A
5.000	5.480	0.319	5.080	251	0401AD24005000-319A
5.125	5.605	0.319	5.205	252	0401AD24005125-319A
5.250	5.730	0.319	5.330	253	0401AD24005250-319A
5.375	5.855	0.319	5.455	254	0401AD24005375-319A
<b>+0.000/-0.004</b>	<b>+0.004/-0.000</b>	<b>+0.008/-0.000</b>	<b>+0.008/-0.000</b>		
5.500	6.130	0.374	5.600	359	0401AD31505500-374A
5.625	6.255	0.374	5.725	360	0401AD31505625-374A

For custom groove calculations, see Appendix C.

Table 8-21. AD Gland Dimensions (Wide) — Inch (Continued)

A Rod Diameter	B Groove Diameter	C Groove Width	D Shoulder Diameter	O-ring Dash Number	AD Part Number (Wide)
<b>+ .000/- .004</b>	<b>+ .004/- .000</b>	<b>+ .008/- .000</b>	<b>+ .008/- .000</b>		
5.750	6.380	0.374	5.850	361	0401AD31505750-374A
6.000	6.630	0.374	6.100	362	0401AD31506000-374A
6.250	6.880	0.374	6.350	363	0401AD31506250-374A
6.500	7.130	0.374	6.600	364	0401AD31506500-374A
6.750	7.380	0.374	6.850	365	0401AD31506750-374A
7.000	7.630	0.374	7.100	366	0401AD31507000-374A
<b>+ .000/- .005</b>	<b>+ .005/- .000</b>	<b>+ .008/- .000</b>	<b>+ .008/- .000</b>		
7.250	7.880	0.374	7.350	367	0401AD31507250-374A
7.500	8.130	0.374	7.600	368	0401AD31507500-374A
7.750	8.380	0.374	7.850	369	0401AD31507750-374A
8.000	8.630	0.374	8.100	370	0401AD31508000-374A
8.250	8.880	0.374	8.350	371	0401AD31508250-374A
8.500	9.130	0.374	8.600	372	0401AD31508500-374A
8.750	9.380	0.374	8.850	373	0401AD31508750-374A
9.000	9.630	0.374	9.100	374	0401AD31509000-374A
9.250	9.880	0.374	9.350	375	0401AD31509250-374A
9.500	10.130	0.374	9.600	376	0401AD31509500-374A
9.750	10.380	0.374	9.850	377	0401AD31509750-374A
<b>+ .000/- .005</b>	<b>+ .005/- .000</b>	<b>+ .008/- .000</b>	<b>+ .010/- .000</b>		
10.000	10.630	0.374	10.100	377	0401AD315010000-374A
10.500	11.130	0.374	10.600	378	0401AD315010500-374A
11.000	11.630	0.374	11.100	379	0401AD315011000-374A
11.500	12.130	0.374	11.600	380	0401AD315011500-374A
12.000	12.630	0.374	12.100	381	0401AD315012000-374A
12.500	13.130	0.374	12.600	381	0401AD315012500-374A
13.000	13.630	0.374	13.100	382	0401AD315013000-374A
13.500	14.130	0.374	13.600	382	0401AD315013500-374A
14.000	14.630	0.374	14.100	383	0401AD315014000-374A
14.500	15.130	0.374	14.600	383	0401AD315014500-374A
15.000	15.630	0.374	15.100	384	0401AD315015000-374A
15.500	16.130	0.374	15.600	384	0401AD315015500-374A
<b>+ .000/- .006</b>	<b>+ .006/- .000</b>	<b>+ .008/- .000</b>	<b>+ .012/- .000</b>		
16.000	16.944	0.551	16.100	461	0401AD472016000-551A
16.500	17.444	0.551	16.600	462	0401AD472016500-551A
17.000	17.944	0.551	17.100	463	0401AD472017000-551A
17.500	18.444	0.551	17.600	464	0401AD472017500-551A
18.000	18.944	0.551	18.100	465	0401AD472018000-551A
18.500	19.444	0.551	18.600	466	0401AD472018500-551A
19.000	19.944	0.551	19.100	467	0401AD472019000-551A
19.500	20.444	0.551	19.600	468	0401AD472019500-551A
20.000	20.944	0.551	20.100	469	0401AD472020000-551A

For custom groove calculations, see Appendix C.

NOTE: For sizes larger than those shown in the table, please contact your local Parker Seal representative.

# Wiper SG Profile

Catalog EPS 5370/USA

## SG Profile, Metal Scraper

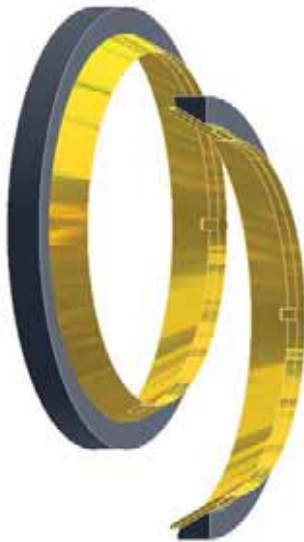

Parker is pleased to offer SG profile metal scrapers as a means to remove the toughest, most abrasive contaminants that may adhere to cylinder rods, including ice, adhesives, coatings, tape and other potentially damaging materials. By using rubber energizing elements behind the dual-contact scrapers, SG provides the best possible removal of stubborn contaminants.

## Technical Data

Standard Materials*	Energizer	Scraper Ring	Temperature Range
N6017	Commercial Nitrile	Bronze	-40°F to 250°F (-40°C to 121°C)
V6083	Commercial FKM	Bronze	-5°F to 400°F (-21°C to 204°C)
4683	Commercial PTFE	Bronze	-Cryogenic to 400°F (204°C)

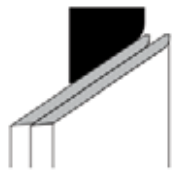

SG Cross-Section

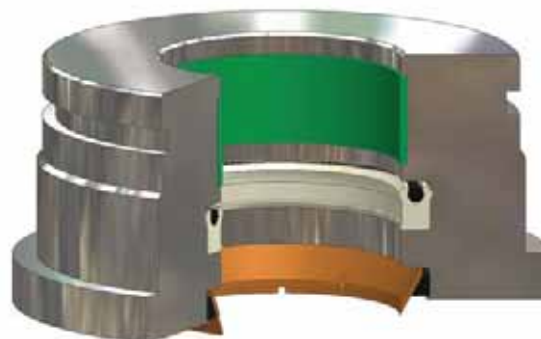

SG installed in Rod Gland

09/01/07

Table 8-23. SG Gland Dimensions — Inch (Continued)

A Rod Diameter	B Groove Diameter	C Groove Width	D Shoulder Diameter	E Shoulder Width	Part Number
+0.000/-0.002	+0.003/-0.003	+0.003/-0.001	+0.000/-0.010	+0.015/-0.000	
1.125	1.500	0.188	1.457	0.022	XXXXSG-01125-187
1.187	1.562	0.188	1.519	0.022	XXXXSG-01187-187
1.250	1.500	0.125	1.464	0.018	XXXXSG-01250-125
1.250	1.625	0.188	1.582	0.022	XXXXSG-01250-187
1.312	1.687	0.188	1.644	0.022	XXXXSG-01312-187
1.375	1.750	0.188	1.707	0.022	XXXXSG-01375-187
1.437	1.812	0.188	1.769	0.022	XXXXSG-01437-187
1.500	1.875	0.188	1.832	0.022	XXXXSG-01500-187
1.562	1.937	0.188	1.894	0.022	XXXXSG-01562-187
1.625	2.000	0.188	1.957	0.022	XXXXSG-01625-187
1.687	2.062	0.188	2.019	0.022	XXXXSG-01687-187
1.750	2.125	0.188	2.082	0.022	XXXXSG-01750-187
1.812	2.187	0.188	2.144	0.022	XXXXSG-01812-187
1.875	2.250	0.188	2.207	0.022	XXXXSG-01875-187
1.937	2.312	0.188	2.269	0.022	XXXXSG-01937-187
2.000	2.375	0.188	2.332	0.022	XXXXSG-02000-187
2.000	2.500	0.250	2.440	0.030	XXXXSG-02000-250
2.062	2.437	0.188	2.394	0.022	XXXXSG-02062-187
2.062	2.562	0.250	2.502	0.030	XXXXSG-02062-250
2.125	2.500	0.188	2.457	0.022	XXXXSG-02125-187
2.125	2.625	0.250	2.565	0.030	XXXXSG-02125-250
2.187	2.562	0.188	2.519	0.022	XXXXSG-02187-187
2.187	2.687	0.250	2.627	0.030	XXXXSG-02187-250
2.250	2.625	0.188	2.582	0.022	XXXXSG-02250-187
2.250	2.750	0.250	2.690	0.030	XXXXSG-02250-250
2.312	2.687	0.188	2.644	0.022	XXXXSG-02312-187
2.312	2.812	0.250	2.752	0.030	XXXXSG-02312-250
2.375	2.750	0.188	2.707	0.022	XXXXSG-02375-187
2.375	2.875	0.250	2.815	0.030	XXXXSG-02375-250
2.437	2.812	0.188	2.769	0.022	XXXXSG-02437-187
2.437	2.937	0.250	2.877	0.030	XXXXSG-02437-250
2.500	2.875	0.188	2.832	0.022	XXXXSG-02500-187
2.500	3.000	0.250	2.940	0.030	XXXXSG-02500-250
2.562	2.937	0.188	2.894	0.022	XXXXSG-02562-187
2.562	3.062	0.250	3.002	0.030	XXXXSG-02562-250
2.625	3.000	0.188	2.957	0.022	XXXXSG-02625-187
2.625	3.125	0.250	3.065	0.030	XXXXSG-02625-250
2.687	3.062	0.188	3.019	0.022	XXXXSG-02687-187
2.687	3.187	0.250	3.127	0.030	XXXXSG-02687-250
2.750	3.125	0.188	3.082	0.022	XXXXSG-02750-187
2.750	3.250	0.250	3.190	0.030	XXXXSG-02750-250
2.812	3.187	0.188	3.144	0.022	XXXXSG-02812-187

For custom groove calculations, see Appendix C.

09/01/07

Table 8-23. SG Gland Dimensions — Inch (Continued)

A Rod Diameter	B Groove Diameter	C Groove Width	D Shoulder Diameter	E Shoulder Width	Part Number
+ .000/- .002	+ .003/- .003	+ .003/- .001	+ .000/- .010	+ .015/- .000	
2.812	3.312	0.250	3.252	0.030	XXXXSG-02812-250
2.875	3.250	0.188	3.207	0.022	XXXXSG-02875-187
2.875	3.375	0.250	3.315	0.030	XXXXSG-02875-250
2.937	3.312	0.188	3.269	0.022	XXXXSG-02937-187
2.937	3.437	0.250	3.377	0.030	XXXXSG-02937-250
3.000	3.375	0.188	3.332	0.022	XXXXSG-03000-187
3.000	3.500	0.250	3.440	0.030	XXXXSG-03000-250
3.125	3.625	0.250	3.565	0.030	XXXXSG-03125-250
3.250	3.750	0.250	3.690	0.030	XXXXSG-03250-250
3.375	3.875	0.250	3.815	0.030	XXXXSG-03375-250
3.500	3.875	0.188	3.832	0.022	XXXXSG-03500-187
3.500	4.000	0.250	3.940	0.030	XXXXSG-03500-250
3.625	4.125	0.250	4.065	0.030	XXXXSG-03625-250
3.750	4.250	0.250	4.190	0.030	XXXXSG-03750-250
3.875	4.375	0.250	4.315	0.030	XXXXSG-03875-250
4.000	4.375	0.188	4.332	0.022	XXXXSG-04000-187
4.000	4.500	0.250	4.440	0.030	XXXXSG-04000-250
4.125	4.625	0.250	4.565	0.030	XXXXSG-04125-250
4.250	4.750	0.250	4.690	0.030	XXXXSG-04250-250
4.375	4.875	0.250	4.815	0.030	XXXXSG-04375-250
4.500	4.875	0.188	4.832	0.022	XXXXSG-04500-187
4.500	5.000	0.250	4.940	0.030	XXXXSG-04500-250
4.500	5.250	0.375	5.160	0.045	XXXXSG-04500-375
4.625	5.125	0.250	5.065	0.030	XXXXSG-04625-250
4.625	5.375	0.375	5.285	0.045	XXXXSG-04625-375
4.750	5.250	0.250	5.190	0.030	XXXXSG-04750-250
4.750	5.500	0.375	5.410	0.045	XXXXSG-04750-375
4.875	5.375	0.250	5.315	0.030	XXXXSG-04875-250
4.875	5.625	0.375	5.535	0.045	XXXXSG-04875-375
5.000	5.375	0.188	5.332	0.022	XXXXSG-05000-187
5.000	5.500	0.250	5.440	0.030	XXXXSG-05000-250
5.000	5.750	0.375	5.660	0.045	XXXXSG-05000-375
5.125	5.875	0.375	5.785	0.045	XXXXSG-05125-375
5.250	5.750	0.250	5.690	0.030	XXXXSG-05250-250
5.250	6.000	0.375	5.910	0.045	XXXXSG-05250-375
5.375	6.125	0.375	6.035	0.045	XXXXSG-05375-375
5.500	5.875	0.188	5.832	0.022	XXXXSG-05500-187
5.500	6.000	0.250	5.940	0.030	XXXXSG-05500-250
5.500	6.250	0.375	6.160	0.045	XXXXSG-05500-375
5.625	6.375	0.375	6.285	0.045	XXXXSG-05625-375
5.750	6.250	0.250	6.190	0.030	XXXXSG-05750-250
5.750	6.500	0.375	6.410	0.045	XXXXSG-05750-375

For custom groove calculations, see Appendix C.

09/01/07





**Table 8-23. SG Gland Dimensions — Inch (Continued)**

A Rod Diameter	B Groove Diameter	C Groove Width	D Shoulder Diameter	E Shoulder Width	Part Number
+0.000/-0.002	+0.003/-0.003	+0.003/-0.001	+0.000/-0.010	+0.015/-0.000	
5.875	6.625	0.375	6.535	0.045	XXXXSG-05875-375
6.000	6.375	0.188	6.332	0.022	XXXXSG-06000-187
6.000	6.500	0.250	6.440	0.030	XXXXSG-06000-250
6.000	6.750	0.375	6.660	0.045	XXXXSG-06000-375
6.250	6.750	0.250	6.690	0.030	XXXXSG-06250-250
6.250	7.000	0.375	6.910	0.045	XXXXSG-06250-375
6.500	6.875	0.188	6.832	0.022	XXXXSG-06500-187
6.500	7.000	0.250	6.940	0.030	XXXXSG-06500-250
6.500	7.250	0.375	7.160	0.045	XXXXSG-06500-375
6.750	7.250	0.250	7.190	0.030	XXXXSG-06750-250
6.750	7.500	0.375	7.410	0.045	XXXXSG-06750-375
7.000	7.375	0.188	7.332	0.022	XXXXSG-07000-187
7.000	7.500	0.250	7.440	0.030	XXXXSG-07000-250
7.000	7.750	0.375	7.660	0.045	XXXXSG-07000-375
7.250	7.750	0.250	7.690	0.030	XXXXSG-07250-250
7.250	8.000	0.375	7.910	0.045	XXXXSG-07250-375
7.500	8.000	0.250	7.940	0.030	XXXXSG-07500-250
7.500	8.250	0.375	8.160	0.045	XXXXSG-07500-375
7.750	8.250	0.250	8.190	0.030	XXXXSG-07750-250
7.750	8.500	0.375	8.410	0.045	XXXXSG-07750-375
8.000	8.500	0.250	8.440	0.030	XXXXSG-08000-250
8.000	8.750	0.375	8.660	0.045	XXXXSG-08000-375
8.000	9.000	0.500	8.880	0.060	XXXXSG-08000-500
8.125	9.125	0.500	9.005	0.060	XXXXSG-08125-500
8.250	8.750	0.250	8.690	0.030	XXXXSG-08250-250
8.250	9.000	0.375	8.910	0.045	XXXXSG-08250-375
8.250	9.250	0.500	9.130	0.060	XXXXSG-08250-500
8.375	9.375	0.500	9.255	0.060	XXXXSG-08375-500
8.500	9.000	0.250	8.940	0.030	XXXXSG-08500-250
8.500	9.250	0.375	9.160	0.045	XXXXSG-08500-375
8.500	9.500	0.500	9.380	0.060	XXXXSG-08500-500
8.625	9.625	0.500	9.505	0.060	XXXXSG-08625-500
8.750	9.250	0.250	9.190	0.030	XXXXSG-08750-250
8.750	9.500	0.375	9.410	0.045	XXXXSG-08750-375
8.750	9.750	0.500	9.630	0.060	XXXXSG-08750-500
8.875	9.875	0.500	9.755	0.060	XXXXSG-08875-500
9.000	9.500	0.250	9.440	0.030	XXXXSG-09000-250
9.000	9.750	0.375	9.660	0.045	XXXXSG-09000-375
9.000	10.000	0.500	9.880	0.060	XXXXSG-09000-500
9.250	10.000	0.375	9.910	0.045	XXXXSG-09250-375

For custom groove calculations, see Appendix C.

Table 8-23. SG Gland Dimensions — Inch (Continued)

A Rod Diameter	B Groove Diameter	C Groove Width	D Shoulder Diameter	E Shoulder Width	Part Number
+ .000/- .002	+ .003/- .003	+ .003/- .001	+ .000/- .010	+ .015/- .000	
9.250	10.250	0.500	10.130	0.060	XXXXSG-09250-500
9.500	10.250	0.375	10.160	0.045	XXXXSG-09500-375
9.500	10.500	0.500	10.380	0.060	XXXXSG-09500-500
9.750	10.500	0.375	10.410	0.045	XXXXSG-09750-375
9.750	10.750	0.500	10.630	0.060	XXXXSG-09750-500
10.000	10.750	0.375	10.660	0.045	XXXXSG-10000-375
10.000	11.000	0.500	10.880	0.060	XXXXSG-10000-500
10.250	11.250	0.500	11.130	0.060	XXXXSG-10250-500
10.500	11.250	0.375	11.160	0.045	XXXXSG-10500-375
10.500	11.500	0.500	11.380	0.060	XXXXSG-10500-500
10.750	11.750	0.500	11.630	0.060	XXXXSG-10750-500
11.000	11.750	0.375	11.660	0.045	XXXXSG-11000-375
11.000	12.000	0.500	11.880	0.060	XXXXSG-11000-500
11.250	12.250	0.500	12.130	0.060	XXXXSG-11250-500
11.500	12.250	0.375	12.160	0.045	XXXXSG-11500-375
11.500	12.500	0.500	12.380	0.060	XXXXSG-11500-500
11.750	12.750	0.500	12.630	0.060	XXXXSG-11750-500
12.000	12.750	0.375	12.660	0.045	XXXXSG-12000-375
12.000	13.000	0.500	12.880	0.060	XXXXSG-12000-500
12.250	13.250	0.500	13.130	0.060	XXXXSG-12250-500
12.500	13.500	0.500	13.380	0.060	XXXXSG-12500-500
12.750	13.750	0.500	13.630	0.060	XXXXSG-12750-500
13.000	14.000	0.500	13.880	0.060	XXXXSG-13000-500
13.500	14.500	0.500	14.380	0.060	XXXXSG-13500-500
14.000	15.000	0.500	14.880	0.060	XXXXSG-14000-500
16.000	17.000	0.500	16.880	0.060	XXXXSG-16000-500
18.000	19.000	0.500	18.880	0.060	XXXXSG-18000-500
20.000	21.000	0.500	20.880	0.060	XXXXSG-20000-500

For custom groove calculations, see Appendix C.

**Part Number Nomenclature — SG Profile**

**Table 8-22. SG Profile — Inch**

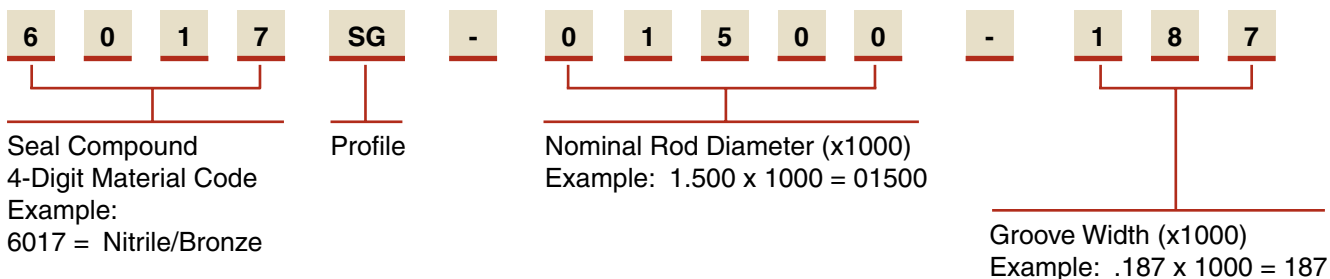

**Gland Dimensions — SG Profile**

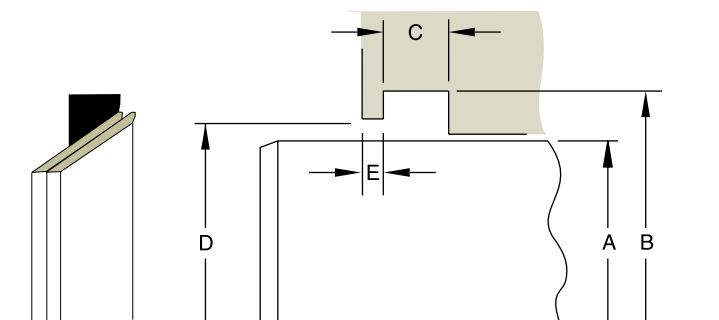

Please refer to Engineering Section 2, page 2-8 for surface finish and additional hardware considerations.

**Table 8-23. SG Gland Dimensions — Inch**

A Rod Diameter	B Groove Diameter	C Groove Width	D Shoulder Diameter	E Shoulder Width	Part Number
+ .000/- .002	+ .003/- .003	+ .003/- .001	+ .000/- .010	+ .015/- .000	
0.250	0.500	0.125	0.464	0.018	XXXXSG-00250-125
0.312	0.562	0.125	0.526	0.018	XXXXSG-00312-125
0.375	0.625	0.125	0.589	0.018	XXXXSG-00375-125
0.437	0.687	0.125	0.651	0.018	XXXXSG-00437-125
0.500	0.750	0.125	0.714	0.018	XXXXSG-00500-125
0.562	0.812	0.125	0.776	0.018	XXXXSG-00562-125
0.625	0.875	0.125	0.839	0.018	XXXXSG-00625-125
0.687	0.937	0.125	0.901	0.018	XXXXSG-00687-125
0.750	1.000	0.125	0.964	0.018	XXXXSG-00750-125
0.750	1.125	0.188	1.082	0.022	XXXXSG-00750-187
0.812	1.062	0.125	1.026	0.018	XXXXSG-00812-125
0.812	1.187	0.188	1.144	0.022	XXXXSG-00812-187
0.875	1.125	0.125	1.089	0.018	XXXXSG-00875-125
0.875	1.250	0.188	1.207	0.022	XXXXSG-00875-187
0.937	1.187	0.125	1.151	0.018	XXXXSG-00937-125
0.937	1.312	0.188	1.269	0.022	XXXXSG-00937-187
1.000	1.250	0.125	1.214	0.018	XXXXSG-01000-125
1.000	1.375	0.188	1.332	0.022	XXXXSG-01000-187
1.062	1.437	0.188	1.394	0.022	XXXXSG-01062-187
1.125	1.375	0.125	1.339	0.018	XXXXSG-01125-125

For custom groove calculations, see Appendix C.

09/01/07





## Contents

Engineering .....	9-2
Materials .....	9-4
Product Offering .....	9-6
Wear Rings / Bearings Profiles	
WPT .....	9-7
WRT .....	9-11
WN .....	9-14
PDT .....	9-18
PDW .....	9-27

Parker offers a complete line of wear rings and bearing products to fit any application. Expertise in both engineered hard plastics and in PTFE makes Parker the global leader for reciprocating bearing materials. By incorporating premium material blends with precision machining tolerances (down to  $\pm 0.001$ "), Parker meets the full spectrum of needs, from heavy-duty hydraulic cylinders operating under the highest temperatures and pressures to pneumatic applications requiring low friction, long life and self-lubrication. Parker wear rings are the best way to combine high performance with economical value.

## Quality Assurance

All Parker wear ring product lines are available from ISO 9000 registered operations in Salt Lake City, Utah and Elgin, Illinois. As such, wear ring production is governed by rigorous quality standards and procedures through a highly trained and qualified workforce. With the assistance of precise, accurate measurement systems and detailed workmanship criteria, Parker delivers first class quality and consistency in every shipment.

## Manufacturing Excellence

Parker wear rings utilize a precision manufacturing process that achieves precise flatness on the bearing surfaces, whereas conventional net-molded bearings can form "dog bone" cross-sections. The result is optimal bearing contact area and compressive strength. The cross-sections shown at left illustrate the differences between these manufacturing methods.

Additionally, available sizing is not limited to existing tooling. *Our processes allow for virtually any width to be produced without assessing a setup charge.*

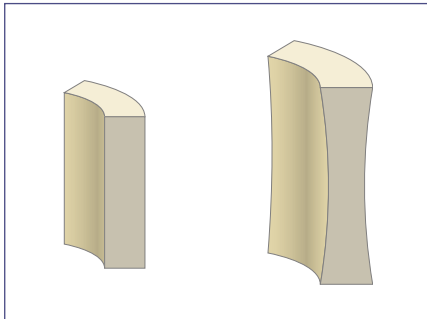

**Figure 9-1. Parker's Precision-Manufactured Cross-Section (left) vs. Conventional Net-Molded Cross-Section (right).**

## Features, Advantages and Benefits

Table 9-1.

Feature	Advantage	Benefit
Dynamic bearing surface contact	Eliminates metal-to-metal contact between components	Prevents rod, piston and seal damage due to scoring and reduces warranty costs
Precision-manufactured cross-section	Enables tighter hardware clearances than conventional wear rings	Increases seal life by reducing extrusion gaps associated with conventional wear rings
Low-friction, premium materials	Reduces frictional heat build-up	Lowers operating temperature and increases seal life
Precise flatness on bearing surface	Maximizes bearing contact area and compressive strength, eliminating the "dog bone" effect of conventional wear rings	Prolongs cylinder life through uniform sideload resistance
Advanced, high performance, polymeric materials	Metal particulates and other contaminants can be imbedded in the wear ring material	Increases cylinder life by helping to protect seals from contamination

09/01/07



## FAQs

There are many factors to consider when designing a system. Following is are the most frequently asked questions regarding bearing design and choosing the right wear ring.

### What is the performance difference between standard-tolerance and tight-tolerance wear rings?

Standard-tolerance wear rings have a radial wall tolerance that is held to  $\pm 0.0025"$ , while tight-tolerance wear rings are held to  $\pm 0.001"$  (under 6"). Tight-tolerance wear rings allow for a more precise fit of components, resulting in less dimensional "play." This allows the extrusion gap to be smaller for tight-tolerance wear rings, thus increasing the seal's pressure rating beyond that of standard-tolerance wear rings. This becomes very important at high temperatures, where pressure ratings of materials can further be reduced. Although it is critical to consider every aspect of each application, a general guideline for product selection can be found in Table 9-2 on page 9-5.

### Wear ring grooves call for larger extrusion gaps. How does this affect the seals' pressure rating?

Since wear rings are used to eliminate metal-to-metal contact between moving parts, there must be a larger gap between them, thus causing a wider extrusion gap. As a result, the seal's pressure ratings will decrease. Pre-established gland dimensions outlined in this catalog always result in a minimum 0.005" clearance for metal components. As such, standard-tolerance wear rings can reduce a seal's pressure capability by up to 50%. Using tight-tolerance wear rings enables the extrusion gaps to be held closer, and the seal's pressure ratings are only reduced by up to 30%. In either case, it is important to select proper seal and back-up materials to accommodate the increased extrusion gaps. Alternatively, Parker Integrated Pistons™ boost performance by providing all of the benefits of wear rings without any increase in extrusion gap whatsoever.

For applications where the seals will be stressed toward their maximum capabilities, gland dimensions can be developed using the equations that accompany each profile. Use these equations to apply desired machining tolerances and clearances. It is critical when determining metal-to-metal clearances to consider the material's compressive properties, which can be found on page 9-5. It is equally important to evaluate how the applied tolerances will affect the seals' extrusion gap. Please contact Parker or your authorized distributor for assistance in developing alternate gland dimensions.

### How is a proper bearing width selected?

When selecting a bearing width, it is crucial to evaluate the side loads that the bearings will have to withstand. Figure 9-2 shows the total pressure area,  $A_p$ , that a radial force from a side load will affect. Area,  $A_p$ , is calculated as follows:

$$A_p = \text{Ø}D \times W$$

where  $D$  is the bearing O.D. for pistons or the bearing I.D. for rods, and  $W$  is the bearing width.

09/01/07

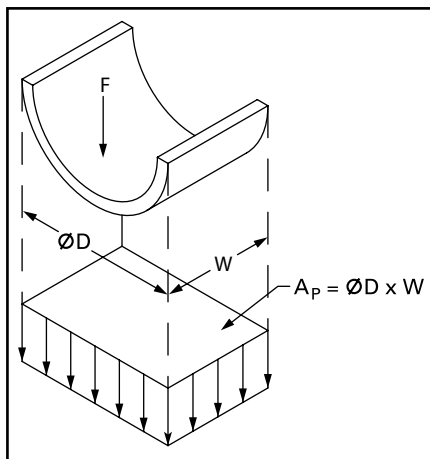

Figure 9-2: Total affected pressure area,  $A_p$

It is important to note that the pressure distribution will not be equally dispersed across this area. Instead, the pressure profile takes the form shown in Figure 9-3. The assumed load-bearing area,  $A_L$ , can be calculated as follows:

$$A_L = \frac{A_p}{5} = \frac{\text{Ø}D \times W}{5}$$

To calculate the allowable radial force,  $F$ , simply multiply the load-bearing area,  $A_L$ , by the permissible compressive load of the material,  $q$ , and divide by the desired factor of safety,  $FS$ .

To calculate the proper bearing width,  $W$ , based on a known radial force:

$$W = \frac{5 \times F}{\text{Ø}D \times q} \times FS$$

Once  $W$  is calculated, round up to the next nominal width (1/8" increments).

To calculate the allowable radial force,  $F$ , based on a known bearing width:

$$F = \frac{A_L \times q}{FS} = \frac{\text{Ø}D \times W \times q}{5 \times FS}$$

Permissible compressive load,  $q$ , can be found in the material properties tables on page 9-5. This value is based upon known material deflection at 73°F and at a specified load. Parker recommends a factor of safety,  $FS$ , of at least 3 to account for changes in physical properties due to increases in system temperature.

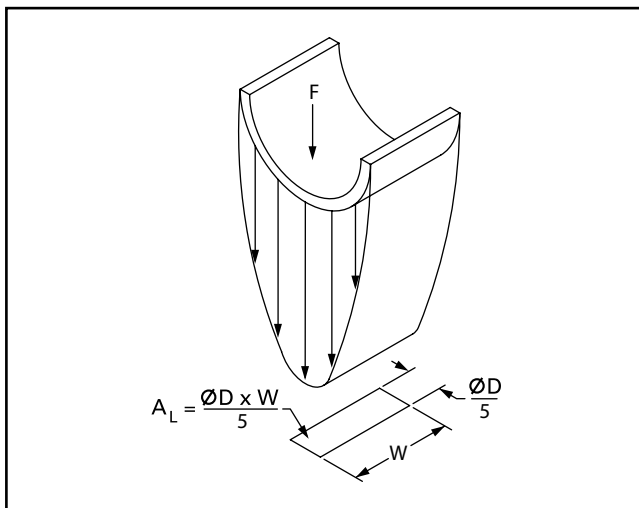

Figure 9-3: Load distribution of radial force,  $F$ , and effective load area,  $A_L$

If additional assistance is required, please contact Parker or your authorized distributor.

### What fluids are wear rings typically compatible with?

MolyGard and WearGard compounds are compatible with petroleum-based hydraulic fluids, transmission fluids, phosphate esters, and many other fluids. PTFE compounds 0401, 0307, and others have outstanding chemical compatibility with a wide range of fluids. Please contact Parker for specific inquiries.

### How does moisture affect wear rings?

Due to nylon's inherent swelling in water, it is recommended that WearGard and MolyGard not be used in applications where water or moisture is present. Filled PTFE compounds or other alternative materials such as polyacetal and composite resins are recommended in such scenarios and are available from Parker.

### Where should the wear ring be installed relative to the seals?

Wear rings should always be installed on the lubrication (wet) side of the seal for best performance. For rod glands, the wear ring should be on the pressure side of the rod seal. For pistons, if only one bearing is to be used, it should be on the side of the piston opposite the rod. This arrangement keeps the piston wear ring further away from the rod wear ring. This becomes critical when the rod is at full extension and provides better leveraging of the two bearing surfaces.

### Which end cut should be used?

There are three types of end cuts available: butt cut, angle cut and step cut. The butt cut is the most common and most economical cut. Angle cuts and step cuts provide added performance by ensuring bearing area overlap at the wear ring's gap. In certain applications, step cut wear rings can be used as buffer seals, protecting the seal from pressure spikes. Figure 9-4 illustrates these three options.

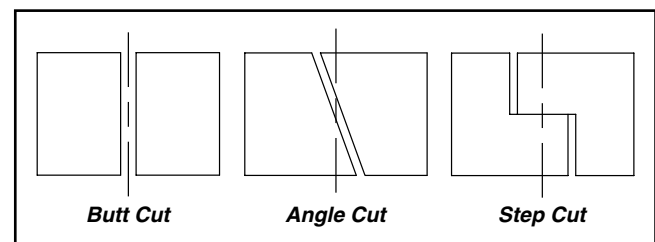

Figure 9-4: End Cuts



# Wear Rings / Bearings Materials

Catalog EPS 5370/USA

## Parker Bearing Materials

Parker bearing materials are backed by over 30 years of manufacturing expertise both in engineered hard plastics and PTFE. Our WearGard and MolyGard strength characteristics meet or exceed most metals traditionally used in wear rings. While many compounds are available, the most commonly used bearing materials are WearGard, MolyGard and filled PTFE (featured at right).



Parker also offers other engineered bearing materials for specialized applications demanding higher temperatures and sideloads. Parker's UltraComp™ CGT provides high temperature bearing performance up to 500°F. Composite, fabric-reinforced resins are also available to accommodate sideloads far more severe than glass-loaded nylon compounds can withstand. Composite resins also resist moisture swell in water-glycol emulsions and other water-based fluids. Polyacetal, Nylatron® and many different PTFE filler combinations are also available for specialized applications. Please contact Parker or your authorized distributor for assistance in selecting alternative bearing materials.

### W4733 — WearGard

Heat stabilized, internally lubricated, 35% glass-reinforced nylon for tight-tolerance wear rings. WearGard is the premium material for the most severe applications due to its dimensional stability, high compressive strength and Parker's proprietary internal lubrication for reduced friction. WearGard is an extremely high endurance compound, retaining its physical properties without degradation. WearGard also features Parker's distinctive green coloring and is available in the WPT and WRT profiles.

### W4650 — MolyGard

Heat stabilized, internally lubricated, 30% glass-reinforced nylon for standard-tolerance wear rings. Very similar physical properties to WearGard, but with an economical advantage. MolyGard is for use in light to medium duty hydraulic applications. Available in the WN profile.

### 0401 — 40% Bronze-Filled PTFE

Primarily used in light duty hydraulic applications, this self-lubricated, long-wearing material offers superior frictional characteristics and high temperature capabilities. Not recommended for use with aluminum bores and soft metal rods or in applications involving moderate to heavy sideloads. Available in the PDT and PDW profiles.

### 0307 — 23% Carbon, 2% Graphite-Filled PTFE

The most popular material for pneumatic applications, this self-lubricated compound ensures long life, low friction and high temperature capabilities. The carbon-graphite fillers allow for outstanding performance without the risk of scratching or scoring soft metal surfaces. Available in the PDT and PDW profiles.

9

Nylatron® is a registered trademark of  
The Polymer Corporation, Reading, PA.

09/01/07



Table 9-2. Physical and Mechanical Properties of Engineered Plastics

Property	Unit	W4733	W4650	W4738	0871 – 0874	Test Method
		WearGard 35% Glass-Reinforced Nylon	MolyGard 30% Glass-Reinforced Nylon	UltraCOMP CGT 10% Carbon-, 10% Graphite-, 10% PTFE-filled	Composite Fabric-Reinforced Resins	
Permissible Compressive Load, $q$	psi	21700	21700	—	65200	—
Tensile Strength	psi	18300	17500	20400	9500	ASTM D638, 73°F
Tensile Modulus	Kpsi	899	952	—	470	ASTM D638, 73°F
Compressive Strength	psi	21500	21000	21700	35000	ASTM D695, 73°F
Shear Strength	psi	9820	9390	—	—	ASTM D732, 73°F
Flexural Strength	psi	25500	22600	30500	—	ASTM D790, 73°F
Flexural Modulus	Kpsi	1100	860	1175	280	ASTM D790, 73°F
Notched IZOD Impact Strength	Ft-Lbs/in	1.15	1.37	1.69	10	ASTM D256, 73°F
Deformation Under Load	%	0.4	0.6	—	4.0	ASTM D621, 24 hrs @ 4000 psi, 73°F
Water Absorption	%	0.5	0.8	0.06	0.1	24 hour immersion, ASTM D570, 73°F
Temperature Range	°F	-65 to +275	-65 to +275	-65 to +500	-40 to +250	—
Rockwell Hardness	M Scale	87	77	100	100	ASTM D785
	R Scale	117	114	—	—	ASTM D785

Table 9-3. Physical and Mechanical Properties of PTFE Compounds

Property	Unit	0401	0307	Test Method
		40% Bronze-Filled PTFE	23% Carbon-, 2% Graphite-Filled PTFE	
Permissible Compressive Load, $q$	psi	9400	3600	—
Tensile Strength	psi	3200	2250	ASTM D1457-81A
Elongation	%	250	100	ASTM D4894
Deformation Under Load	%	3.1	2.5	ASTM D621, 24 hrs @ 2000 psi, 70°F
Coefficient of Friction	—	0.23	0.24	ASTM D3702
Temperature Range	°F	-200 to +575	-360 to +575	—
Shore D Hardness	—	65	64	ASTM D2240-75

# Wear Rings / Bearings Product Offering











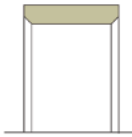

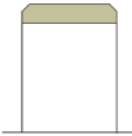

Catalog EPS 5370/USA

## Product Line

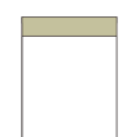
No matter what the application demands, Parker's diverse bearing product line ensures that performance requirements are met with maximized value. When pressure and temperature reach their extremes, WPT and WRT profiles help reduce the seal extrusion gap, assuring the utmost seal performance and leakage control. Conversely, in high volume, light-duty hydraulic cylinders, where pressure and temperature are not excessive, Parker's WN profile stands out as the most economical choice for long-lasting piston and rod bearings. When frictional forces must be kept to a minimum in pneumatic applications, PTFE bearing profiles PDT and PDW provide precision fitting and minimal frictional losses.

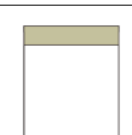
## Profiles

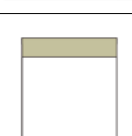
Table 9-4: Product Profiles

Series	Description	Application (Duty)				Page
		Light	Medium	Heavy	Pneumatic	
WPT 	Tight-Tolerance Piston Wear Rings					9-7
WRT 	Tight-Tolerance Rod Wear Rings					9-11
WN 	Commercial Wear Rings for Rod and Piston					9-14
PDT 	PTFE Wear Strip for Rod and Piston					9-18
PDW 	PTFE Machined Wear Rings for Rod and Piston					9-27

# Wear Ring / Bearing WPT Profile

Catalog EPS 5370/USA



## WPT Profile, Tight-Tolerance Piston Wear Ring

WPT tight-tolerance piston wear rings are the premier bearings for light- to heavy-duty hydraulic applications. WPTs are available in standard sizes from 1" up to 12" bore diameters (larger sizes upon request). WPT wear rings feature chamfered corners on the I.D. and are designed to snap closed during assembly to hold tight against the piston, eliminating bore interference and simplifying installation.

## Technical Data

### Standard Material

W4733 WearGard

### Radial Tolerance

+0.000"/ -0.002" (up to 6" O.D.); +0.000/-0.003" (6" to 12" O.D.)

### End Cuts

Butt Cut, Angle Cut, Step Cut

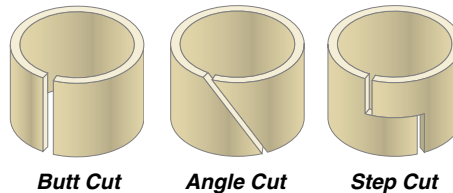

Butt Cut

Angle Cut

Step Cut

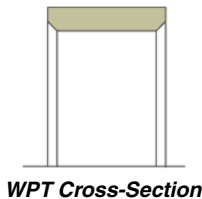

WPT Cross-Section

### Options

Virtually any width can be produced without assessing a setup charge. Additionally, other cross-sections not shown are available when required.



*Piston sealing system  
comprised of WPT wear rings and  
BP bi-directional piston seal*

9

# WPT Profile

## Part Number Nomenclature — WPT Profile

Table 9-5. WPT Profile

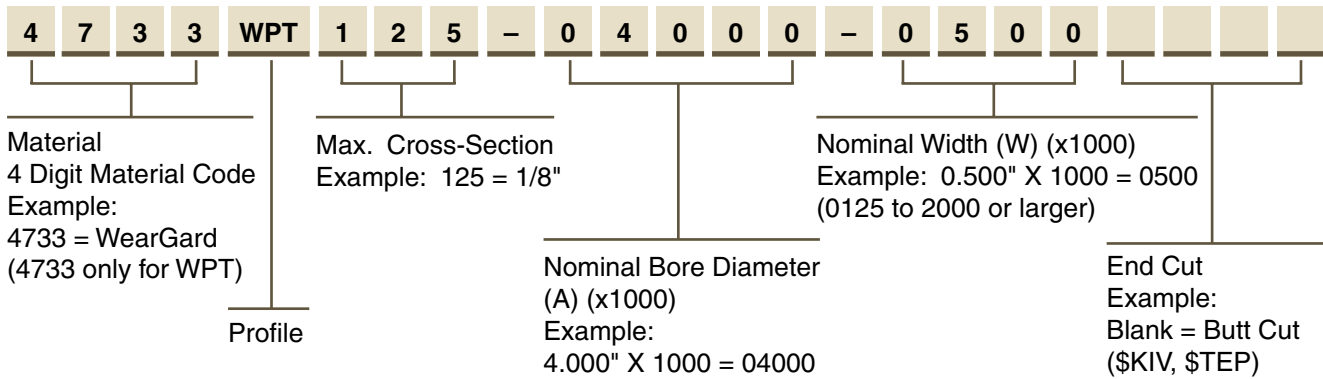

## Gland Dimensions — WPT Profile

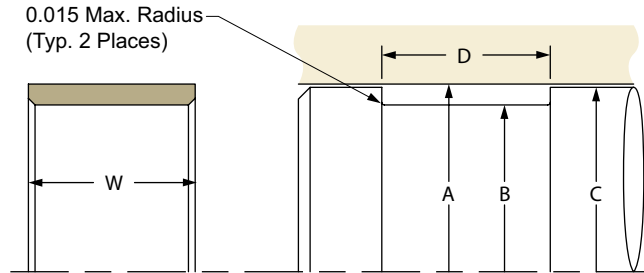

Please refer to Engineering Section 2, page 2-8 for surface finish and additional hardware considerations.

Table 9-6. WPT Gland Dimensions — Inch

A Bore Diameter	B Groove Diameter	C Piston Diameter	D Groove Width	Part Number
+ .002/- .000	+ .000/- .002	+ .000/- .002	+ .010/- .000	
1.000	0.875	0.983	D = W + 0.010"	4733WPT062-01000-XXXX
1.125	1.000	1.108	D = W + 0.010"	4733WPT062-01125-XXXX
1.250	1.125	1.233	D = W + 0.010"	4733WPT062-01250-XXXX
1.375	1.250	1.358	D = W + 0.010"	4733WPT062-01375-XXXX
1.500	1.375	1.483	D = W + 0.010"	4733WPT062-01500-XXXX
1.625	1.500	1.608	D = W + 0.010"	4733WPT062-01625-XXXX
1.750	1.625	1.733	D = W + 0.010"	4733WPT062-01750-XXXX
1.875	1.750	1.858	D = W + 0.010"	4733WPT062-01875-XXXX
2.375	2.250	2.358	D = W + 0.010"	4733WPT062-02375-XXXX
2.625	2.500	2.608	D = W + 0.010"	4733WPT062-02625-XXXX
+ .002/- .000	+ .000/- .002	+ .000/- .002	+ .010/- .000	
1.000	0.749	0.983	D = W + 0.010"	4733WPT125-01000-XXXX
1.125	0.874	1.108	D = W + 0.010"	4733WPT125-01125-XXXX
1.250	0.999	1.233	D = W + 0.010"	4733WPT125-01250-XXXX
1.375	1.124	1.358	D = W + 0.010"	4733WPT125-01375-XXXX
1.500	1.249	1.483	D = W + 0.010"	4733WPT125-01500-XXXX
1.625	1.374	1.608	D = W + 0.010"	4733WPT125-01625-XXXX
1.750	1.499	1.733	D = W + 0.010"	4733WPT125-01750-XXXX
1.875	1.624	1.858	D = W + 0.010"	4733WPT125-01875-XXXX

For custom groove calculations, see Appendix C.

09/01/07



Table 9-6. WPT Gland Dimensions — Inch (Continued)

A Bore Diameter	B Groove Diameter	C Piston Diameter	D Groove Width	Part Number
<b>+ .002/- .000</b>	<b>+ .000/- .002</b>	<b>+ .000/- .002</b>	<b>+ .010/- .000</b>	
2.000	1.749	1.983	D = W + 0.010"	4733WPT125-02000-XXXX
2.125	1.874	2.108	D = W + 0.010"	4733WPT125-02125-XXXX
2.250	1.999	2.233	D = W + 0.010"	4733WPT125-02250-XXXX
2.375	2.124	2.358	D = W + 0.010"	4733WPT125-02375-XXXX
2.500	2.249	2.483	D = W + 0.010"	4733WPT125-02500-XXXX
2.625	2.374	2.608	D = W + 0.010"	4733WPT125-02625-XXXX
2.750	2.499	2.733	D = W + 0.010"	4733WPT125-02750-XXXX
2.875	2.624	2.858	D = W + 0.010"	4733WPT125-02875-XXXX
3.000	2.749	2.983	D = W + 0.010"	4733WPT125-03000-XXXX
3.125	2.874	3.108	D = W + 0.010"	4733WPT125-03125-XXXX
3.250	2.999	3.233	D = W + 0.010"	4733WPT125-03250-XXXX
3.375	3.124	3.358	D = W + 0.010"	4733WPT125-03375-XXXX
3.500	3.249	3.483	D = W + 0.010"	4733WPT125-03500-XXXX
3.625	3.374	3.608	D = W + 0.010"	4733WPT125-03625-XXXX
3.750	3.499	3.733	D = W + 0.010"	4733WPT125-03750-XXXX
3.875	3.624	3.858	D = W + 0.010"	4733WPT125-03875-XXXX
3.937	3.687	3.920	D = W + 0.010"	4733WPT125-03937-XXXX
4.000	3.749	3.983	D = W + 0.010"	4733WPT125-04000-XXXX
4.125	3.874	4.108	D = W + 0.010"	4733WPT125-04125-XXXX
4.250	3.999	4.233	D = W + 0.010"	4733WPT125-04250-XXXX
4.375	4.124	4.358	D = W + 0.010"	4733WPT125-04375-XXXX
4.500	4.249	4.483	D = W + 0.010"	4733WPT125-04500-XXXX
4.625	4.374	4.608	D = W + 0.010"	4733WPT125-04625-XXXX
4.750	4.499	4.733	D = W + 0.010"	4733WPT125-04750-XXXX
4.875	4.624	4.858	D = W + 0.010"	4733WPT125-04875-XXXX
<b>+ .004/- .000</b>	<b>+ .000/- .003</b>	<b>+ .000/- .003</b>	<b>+ .010/- .000</b>	
5.000	4.749	4.982	D = W + 0.010"	4733WPT125-05000-XXXX
5.125	4.874	5.107	D = W + 0.010"	4733WPT125-05125-XXXX
5.250	4.999	5.232	D = W + 0.010"	4733WPT125-05250-XXXX
5.375	5.124	5.357	D = W + 0.010"	4733WPT125-05375-XXXX
5.500	5.249	5.482	D = W + 0.010"	4733WPT125-05500-XXXX
5.625	5.374	5.607	D = W + 0.010"	4733WPT125-05625-XXXX
5.750	5.499	5.732	D = W + 0.010"	4733WPT125-05750-XXXX
6.000	5.749	5.980	D = W + 0.010"	4733WPT125-06000-XXXX
6.250	5.999	6.230	D = W + 0.010"	4733WPT125-06250-XXXX
6.500	6.249	6.480	D = W + 0.010"	4733WPT125-06500-XXXX
6.750	6.499	6.730	D = W + 0.010"	4733WPT125-06750-XXXX
7.000	6.749	6.980	D = W + 0.010"	4733WPT125-07000-XXXX
7.500	7.249	7.480	D = W + 0.010"	4733WPT125-07500-XXXX

For custom groove calculations, see Appendix C.

**WPT Profile****Table 9-6. WPT Gland Dimensions Inch (Continued)**

A Bore Diameter	B Groove Diameter	C Piston Diameter	D Groove Width	Part Number
<b>+0.006/-0.000</b>	<b>+0.000/-0.004</b>	<b>+0.000/-0.004</b>	<b>+0.010/-0.000</b>	
8.000	7.749	7.979	D = W + 0.010"	<b>4733WPT125-08000-XXXX</b>
8.500	8.249	8.479	D = W + 0.010"	<b>4733WPT125-08500-XXXX</b>
<b>+0.006/-0.000</b>	<b>+0.000/-0.004</b>	<b>+0.000/-0.004</b>	<b>+0.010/-0.000</b>	
9.000	8.749	8.979	D = W + 0.010"	<b>4733WPT125-09000-XXXX</b>
9.500	9.249	9.479	D = W + 0.010"	<b>4733WPT125-09500-XXXX</b>
10.000	9.749	9.979	D = W + 0.010"	<b>4733WPT125-10000-XXXX</b>
10.500	10.249	10.479	D = W + 0.010"	<b>4733WPT125-10500-XXXX</b>
<b>+0.006/-0.000</b>	<b>+0.000/-0.004</b>	<b>+0.000/-0.004</b>	<b>+0.010/-0.000</b>	
11.000	10.749	10.979	D = W + 0.010"	<b>4733WPT125-11000-XXXX</b>
11.500	11.249	11.479	D = W + 0.010"	<b>4733WPT125-11500-XXXX</b>
12.000	11.749	11.979	D = W + 0.010"	<b>4733WPT125-12000-XXXX</b>

For custom groove calculations, see Appendix C.

NOTE: For sizes larger than those shown in the table, please contact your local Parker Seal representative.

**WPT Groove Calculation**

See Piston Wear Ring Groove Calculation in Appendix C.



# Wear Ring / Bearing WRT Profile

Catalog EPS 5370/USA



## WRT Profile, Tight-Tolerance Rod Wear Ring

WRT tight-tolerance rod wear rings, when combined with the WPT profile, complete the premier cylinder bearing system. Recommended for light- to heavy-duty hydraulic applications, they are available in standard sizes from 7/8" up to 7" rod diameters (larger sizes upon request). WRTs feature chamfered corners on the O.D. and are designed to snap open during assembly to hold tight against the head gland, eliminating rod interference and simplifying installation.

## Technical Data

### Standard Material

W4733 WearGard

### Radial Tolerance

+0.000"/-0.002" (up to 5-3/4" I.D.); +0.000"/-0.003" (5-3/4" to 7" I.D.)

### End Cuts

Butt Cut, Angle Cut, Step Cut

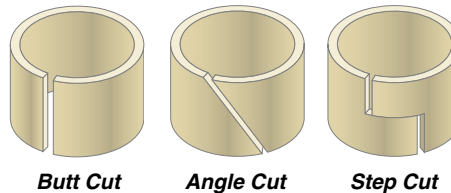

Butt Cut

Angle Cut

Step Cut

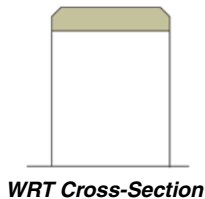

WRT Cross-Section

### Options

Virtually any width can be produced without assessing a setup charge. Additionally, other cross-sections not shown are available when required.

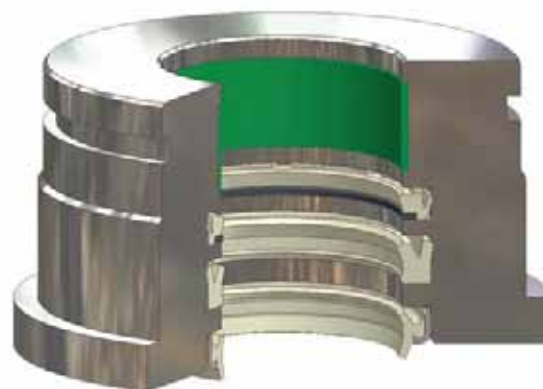

*Rod sealing system comprised of  
WRT wear ring, BR buffer ring assembly,  
BT u-cup and AH canned wiper*

# WRT Profile

## Part Number Nomenclature — WRT Profile

Table 9-7. WRT Profile

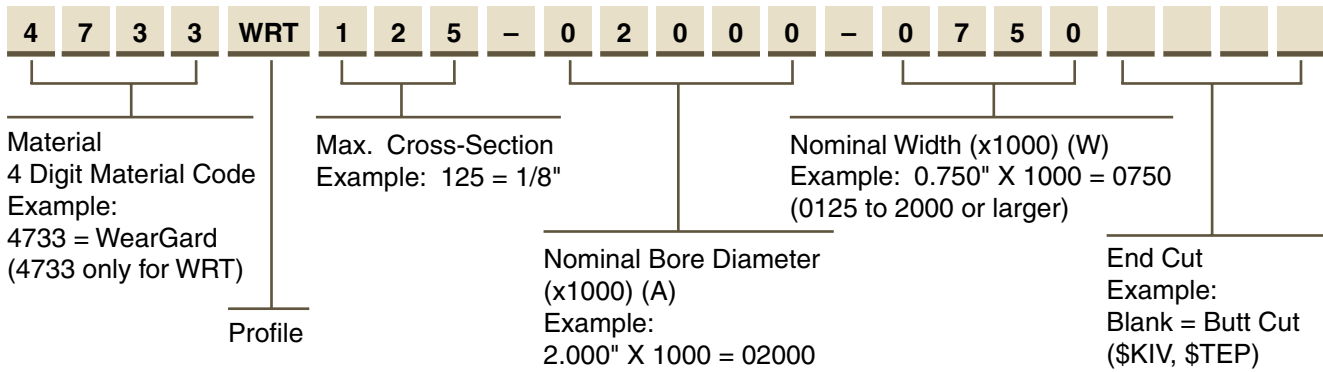

## Gland Dimensions — WRT Profile

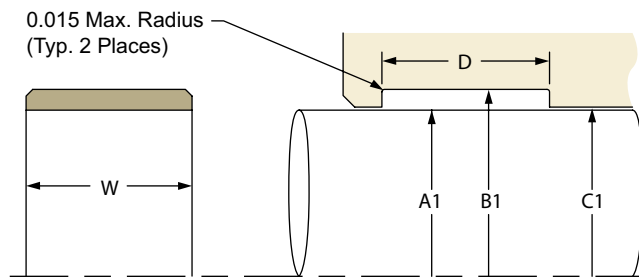

Please refer to Engineering Section 2, page 2-8 for surface finish and additional hardware considerations.

Table 9-8. WRT Gland Dimensions — Inch

A1 Rod Diameter	B1 Groove Diameter	C1 Throat Diameter	D Groove Width	Part Number
+ .000/- .002	+ .002/- .000	+ .002/- .000	+ .010/- .000	
0.875	1.000	0.892	D = W + 0.010"	4733WRT062-00875-XXXX
1.000	1.125	1.017	D = W + 0.010"	4733WRT062-01000-XXXX
1.125	1.250	1.142	D = W + 0.010"	4733WRT062-01125-XXXX
1.250	1.375	1.267	D = W + 0.010"	4733WRT062-01250-XXXX
1.375	1.500	1.392	D = W + 0.010"	4733WRT062-01375-XXXX
1.500	1.625	1.517	D = W + 0.010"	4733WRT062-01500-XXXX
1.625	1.750	1.642	D = W + 0.010"	4733WRT062-01625-XXXX
1.750	1.875	1.767	D = W + 0.010"	4733WRT062-01750-XXXX
2.250	2.375	2.267	D = W + 0.010"	4733WRT062-02250-XXXX
2.500	2.625	2.517	D = W + 0.010"	4733WRT062-02250-XXXX
+ .000/- .002	+ .002/- .000	+ .002/- .000	+ .010/- .000	
0.750	1.001	0.767	D = W + 0.010"	4733WRT125-00750-XXXX
0.875	1.126	0.892	D = W + 0.010"	4733WRT125-00875-XXXX
1.000	1.251	1.017	D = W + 0.010"	4733WRT125-01000-XXXX
1.125	1.376	1.142	D = W + 0.010"	4733WRT125-01125-XXXX
1.250	1.501	1.267	D = W + 0.010"	4733WRT125-01250-XXXX
1.375	1.626	1.392	D = W + 0.010"	4733WRT125-01375-XXXX
1.500	1.751	1.517	D = W + 0.010"	4733WRT125-01500-XXXX
1.625	1.876	1.642	D = W + 0.010"	4733WRT125-01625-XXXX
1.750	2.001	1.767	D = W + 0.010"	4733WRT125-01750-XXXX
1.875	2.126	1.892	D = W + 0.010"	4733WRT125-01875-XXXX

For custom groove calculations, see Appendix C.

09/01/07



Table 9-8. WRT Gland Dimensions — Inch (Continued)

A1 Rod Diameter	B1 Groove Diameter	C1 Throat Diameter	D Groove Width	Part Number
+ .000/- .002	+ .002/- .000	+ .002/- .000	+ .010/- .000	
2.000	2.251	2.017	D = W + 0.010"	4733WRT125-02000-XXXX
2.125	2.376	2.142	D = W + 0.010"	4733WRT125-02125-XXXX
2.250	2.501	2.267	D = W + 0.010"	4733WRT125-02250-XXXX
2.375	2.626	2.392	D = W + 0.010"	4733WRT125-02375-XXXX
2.500	2.751	2.517	D = W + 0.010"	4733WRT125-02500-XXXX
2.625	2.876	2.642	D = W + 0.010"	4733WRT125-02625-XXXX
2.750	3.001	2.767	D = W + 0.010"	4733WRT125-02750-XXXX
2.875	3.126	2.892	D = W + 0.010"	4733WRT125-02875-XXXX
3.000	3.251	3.017	D = W + 0.010"	4733WRT125-03000-XXXX
3.125	3.376	3.142	D = W + 0.010"	4733WRT125-03125-XXXX
3.250	3.501	3.267	D = W + 0.010"	4733WRT125-03250-XXXX
3.375	3.626	3.392	D = W + 0.010"	4733WRT125-03375-XXXX
3.500	3.751	3.517	D = W + 0.010"	4733WRT125-03500-XXXX
3.625	3.876	3.642	D = W + 0.010"	4733WRT125-03625-XXXX
3.750	4.001	3.767	D = W + 0.010"	4733WRT125-03750-XXXX
3.875	4.126	3.892	D = W + 0.010"	4733WRT125-03875-XXXX
3.937	4.188	3.954	D = W + 0.010"	4733WRT125-03937-XXXX
4.000	4.251	4.017	D = W + 0.010"	4733WRT125-04000-XXXX
4.125	4.376	4.142	D = W + 0.010"	4733WRT125-04125-XXXX
4.250	4.501	4.267	D = W + 0.010"	4733WRT125-04250-XXXX
4.375	4.626	4.392	D = W + 0.010"	4733WRT125-04375-XXXX
4.500	4.751	4.517	D = W + 0.010"	4733WRT125-04500-XXXX
4.625	4.876	4.642	D = W + 0.010"	4733WRT125-04625-XXXX
4.750	5.001	4.767	D = W + 0.010"	4733WRT125-04750-XXXX
4.875	5.126	4.892	D = W + 0.010"	4733WRT125-04875-XXXX
5.000	5.251	5.017	D = W + 0.010"	4733WRT125-05000-XXXX
5.125	5.376	5.142	D = W + 0.010"	4733WRT125-05125-XXXX
5.250	5.501	5.267	D = W + 0.010"	4733WRT125-05250-XXXX
5.375	5.626	5.392	D = W + 0.010"	4733WRT125-05375-XXXX
5.500	5.751	5.517	D = W + 0.010"	4733WRT125-05500-XXXX
5.625	5.876	5.642	D = W + 0.010"	4733WRT125-05625-XXXX
+ .000/- .004	+ .003/- .000	+ .003/- .000	+ .010/- .000	
5.750	6.001	5.770	D = W + 0.010"	4733WRT125-05750-XXXX
6.000	6.251	6.020	D = W + 0.010"	4733WRT125-06000-XXXX
6.250	6.501	6.270	D = W + 0.010"	4733WRT125-06250-XXXX
6.500	6.751	6.520	D = W + 0.010"	4733WRT125-06500-XXXX
6.750	7.001	6.770	D = W + 0.010"	4733WRT125-06750-XXXX
7.000	7.251	7.020	D = W + 0.010"	4733WRT125-07000-XXXX

For custom groove calculations, see Appendix C.

NOTE: For sizes larger than those shown in the table, please contact your local Parker representative.

## WRT Groove Calculation

See Rod Wear-Ring Groove Calculation in Appendix C.

# Wear Ring / Bearing WN Profile

Catalog EPS 5370/USA

## WN Profile, Commercial Wear Ring



WN commercial wear rings can be used for either pistons or rods and are the most economical bearing solution for light- to medium-duty hydraulic applications. MolyGard bearing material offers the combination of long life and high strength. WNs are available in standard sizes (1/8" cross-section) from 3/4" up to 11-3/4" rod diameters and 1" to 12" bore diameters (larger sizes upon request).

## Technical Data

**Standard Material**  
W4650 MolyGard

**Radial Tolerance**  
+.000"/-.005"

**End Cuts**  
Butt Cut only

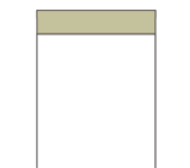

WN Cross-Section

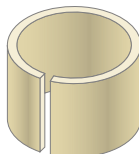

Butt Cut

## Options

Virtually any width can be produced without assessing a setup charge. Additionally, other cross-sections not shown are available when required.

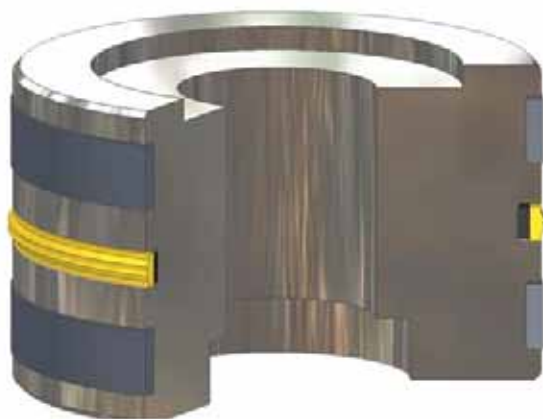

*Piston sealing system comprised of WN wear rings and PSP bi-directional piston seal*

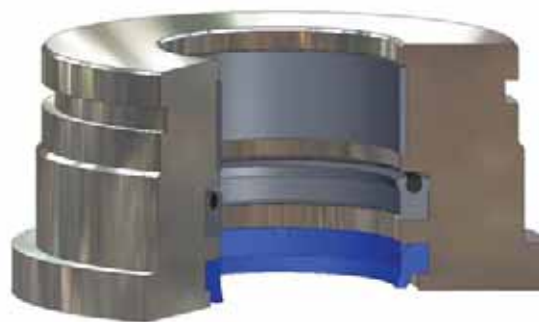

*Rod sealing system comprised of WN wear ring, Type B PolyPak and SHD wiper*

09/01/07

**Part Number Nomenclature — WN Profile**

Table 9-9. WN Profile

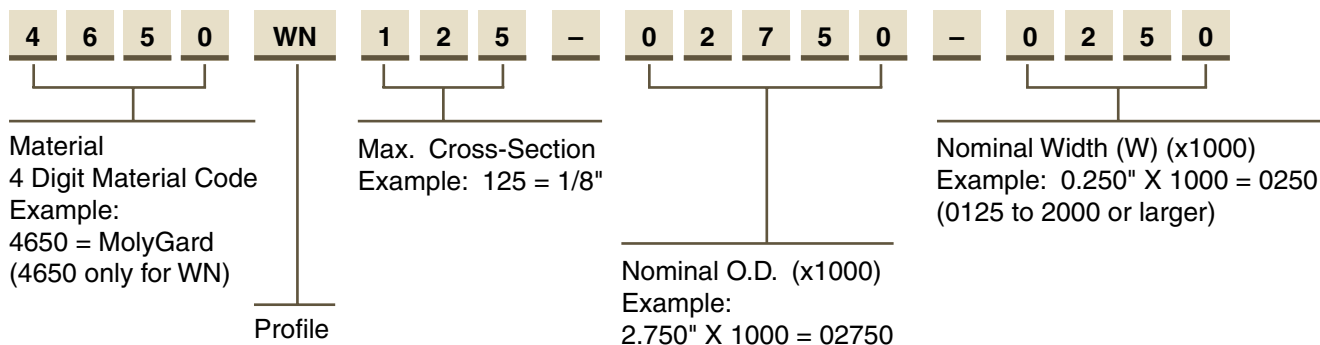

**Gland Dimensions — WN Profile**

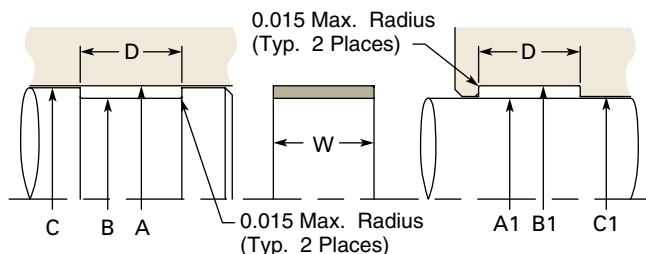

Please refer to Engineering Section 2, page 2-8 for surface finish and additional hardware considerations.

Table 9-10. WN Gland Dimensions — Inch

Piston			Rod			D Groove Width	Part Number
A Bore Diameter	B Groove Diameter	C Piston Diameter	A1 Rod Diameter	B1 Groove Diameter	C1 Throat Diameter		
<b>+0.002/-0.000</b>	<b>+0.000/-0.002</b>	<b>+0.000/-0.002</b>	<b>+0.000/-0.002</b>	<b>+0.002/-0.000</b>	<b>+0.002/-0.000</b>	<b>+0.010/-0.000</b>	
1.000	0.875	0.977	0.875	1.000	0.898	D = W + 0.010"	4650WN062-01000-XXXX
1.125	1.000	1.102	1.000	1.125	1.023	D = W + 0.010"	4650WN062-01125-XXXX
1.250	1.125	1.227	1.125	1.250	1.148	D = W + 0.010"	4650WN062-01250-XXXX
1.375	1.250	1.352	1.250	1.375	1.273	D = W + 0.010"	4650WN062-01375-XXXX
1.500	1.375	1.477	1.375	1.500	1.398	D = W + 0.010"	4650WN062-01500-XXXX
1.625	1.500	1.602	1.500	1.625	1.523	D = W + 0.010"	4650WN062-01625-XXXX
1.750	1.625	1.727	1.625	1.750	1.648	D = W + 0.010"	4650WN062-01750-XXXX
1.875	1.750	1.852	1.750	1.875	1.773	D = W + 0.010"	4650WN062-01875-XXXX
2.375	2.250	2.352	2.250	2.375	2.273	D = W + 0.010"	4650WN062-02375-XXXX
2.625	2.500	2.602	2.500	2.625	2.523	D = W + 0.010"	4650WN062-02625-XXXX
<b>+0.002/-0.000</b>	<b>+0.000/-0.002</b>	<b>+0.000/-0.002</b>	<b>+0.000/-0.002</b>	<b>+0.002/-0.000</b>	<b>+0.002/-0.000</b>	<b>+0.010/-0.000</b>	
1.000	0.749	0.977	0.750	1.001	0.773	D = W + 0.010"	4650WN125-01000-XXXX
1.125	0.874	1.102	0.875	1.126	0.898	D = W + 0.010"	4650WN125-01125-XXXX
1.250	0.999	1.227	1.000	1.251	1.023	D = W + 0.010"	4650WN125-01250-XXXX
1.375	1.124	1.352	1.125	1.376	1.148	D = W + 0.010"	4650WN125-01375-XXXX
1.500	1.249	1.477	1.250	1.501	1.273	D = W + 0.010"	4650WN125-01500-XXXX
1.625	1.374	1.602	1.375	1.626	1.398	D = W + 0.010"	4650WN125-01625-XXXX
1.750	1.499	1.727	1.500	1.751	1.523	D = W + 0.010"	4650WN125-01750-XXXX
1.875	1.624	1.852	1.625	1.876	1.648	D = W + 0.010"	4650WN125-01875-XXXX

For custom groove calculations, see Appendix C.

09/01/07



## WN Profile

Table 9-10. WN Gland Dimensions — Inch (Continued)

Piston			Rod			D Groove Width	Part Number
A Bore Diameter	B Groove Diameter	C Piston Diameter	A1 Rod Diameter	B1 Groove Diameter	C1 Throat Diameter		
+0.002/-0.000	+0.000/-0.002	+0.000/-0.002	+0.000/-0.002	+0.002/-0.000	+0.002/-0.000	+0.010/-0.000	
2.000	1.749	1.977	1.750	2.001	1.773	D = W + 0.010"	4650WN125-02000-XXXX
2.125	1.874	2.102	1.875	2.126	1.898	D = W + 0.010"	4650WN125-02125-XXXX
2.250	1.999	2.227	2.000	2.251	2.023	D = W + 0.010"	4650WN125-02250-XXXX
2.375	2.124	2.352	2.125	2.376	2.148	D = W + 0.010"	4650WN125-02375-XXXX
2.500	2.249	2.477	2.250	2.501	2.273	D = W + 0.010"	4650WN125-02500-XXXX
2.625	2.374	2.602	2.375	2.626	2.398	D = W + 0.010"	4650WN125-02625-XXXX
2.750	2.499	2.727	2.500	2.751	2.523	D = W + 0.010"	4650WN125-02750-XXXX
2.875	2.624	2.852	2.625	2.876	2.648	D = W + 0.010"	4650WN125-02875-XXXX
3.000	2.749	2.977	2.750	3.001	2.773	D = W + 0.010"	4650WN125-03000-XXXX
3.125	2.874	3.102	2.875	3.126	2.898	D = W + 0.010"	4650WN125-03125-XXXX
3.250	2.999	3.227	3.000	3.251	3.023	D = W + 0.010"	4650WN125-03250-XXXX
3.375	3.124	3.352	3.125	3.376	3.148	D = W + 0.010"	4650WN125-03375-XXXX
3.500	3.249	3.477	3.250	3.501	3.273	D = W + 0.010"	4650WN125-03500-XXXX
3.625	3.374	3.602	3.375	3.626	3.398	D = W + 0.010"	4650WN125-03625-XXXX
3.750	3.499	3.727	3.500	3.751	3.523	D = W + 0.010"	4650WN125-03750-XXXX
3.875	3.624	3.852	3.625	3.876	3.648	D = W + 0.010"	4650WN125-03875-XXXX
3.937	3.687	3.914	3.687	3.939	3.711	D = W + 0.010"	4650WN125-03937-XXXX
4.000	3.749	3.977	3.750	4.001	3.773	D = W + 0.010"	4650WN125-04000-XXXX
4.125	3.874	4.102	3.875	4.126	3.898	D = W + 0.010"	4650WN125-04125-XXXX
4.250	3.999	4.227	4.000	4.251	4.023	D = W + 0.010"	4650WN125-04250-XXXX
4.375	4.124	4.352	4.125	4.376	4.148	D = W + 0.010"	4650WN125-04375-XXXX
4.500	4.249	4.477	4.250	4.501	4.273	D = W + 0.010"	4650WN125-04500-XXXX
4.625	4.374	4.602	4.375	4.626	4.398	D = W + 0.010"	4650WN125-04625-XXXX
4.750	4.499	4.727	4.500	4.751	4.523	D = W + 0.010"	4650WN125-04750-XXXX
4.875	4.624	4.852	4.625	4.876	4.648	D = W + 0.010"	4650WN125-04875-XXXX
+0.004/-0.000	+0.000/-0.003	+0.000/-0.003	+0.000/-0.004	+0.003/-0.000	+0.003/-0.000	+0.010/-0.000	
5.000	4.749	4.976	4.750	5.001	4.774	D = W + 0.010"	4650WN125-05000-XXXX
5.125	4.874	5.101	4.875	5.126	4.899	D = W + 0.010"	4650WN125-05125-XXXX
5.250	4.999	5.226	5.000	5.251	5.024	D = W + 0.010"	4650WN125-05250-XXXX
5.375	5.124	5.351	5.125	5.376	5.149	D = W + 0.010"	4650WN125-05375-XXXX
5.500	5.249	5.476	5.250	5.501	5.274	D = W + 0.010"	4650WN125-05500-XXXX
5.625	5.374	5.601	5.375	5.626	5.399	D = W + 0.010"	4650WN125-05625-XXXX
5.750	5.499	5.726	5.500	5.751	5.524	D = W + 0.010"	4650WN125-05750-XXXX
6.000	5.749	5.976	5.750	6.001	5.774	D = W + 0.010"	4650WN125-06000-XXXX
6.250	5.999	6.226	6.000	6.251	6.024	D = W + 0.010"	4650WN125-06250-XXXX
6.375	6.124	6.351	6.125	6.376	6.149	D = W + 0.010"	4650WN125-06375-XXXX
6.500	6.249	6.476	6.250	6.501	6.274	D = W + 0.010"	4650WN125-06500-XXXX
6.750	6.499	6.726	6.500	6.751	6.524	D = W + 0.010"	4650WN125-06750-XXXX
6.875	6.624	6.851	6.625	6.876	6.649	D = W + 0.010"	4650WN125-06875-XXXX
7.000	6.749	6.976	6.750	7.001	6.774	D = W + 0.010"	4650WN125-07000-XXXX
7.250	6.999	7.226	7.000	7.251	7.024	D = W + 0.010"	4650WN125-07250-XXXX

For custom groove calculations, see Appendix C.

09/01/07



Table 9-10. WN Gland Dimensions — Inch (Continued)

Piston			Rod			D Groove Width	Part Number
A Bore Diameter	B Groove Diameter	C Piston Diameter	A1 Rod Diameter	B1 Groove Diameter	C1 Throat Diameter		
<b>+0.004/-0.000</b>	<b>+0.000/-0.003</b>	<b>+0.000/-0.003</b>	<b>+0.000/-0.004</b>	<b>+0.003/-0.000</b>	<b>+0.003/-0.000</b>	<b>+0.010/-0.000</b>	
7.313	7.062	7.289	7.063	7.314	7.087	D = W + 0.010"	4650WN125-07312-XXXX
7.500	7.249	7.476	7.250	7.501	7.274	D = W + 0.010"	4650WN125-07500-XXXX
7.750	7.499	7.726	7.500	7.751	7.524	D = W + 0.010"	4650WN125-07750-XXXX
<b>+0.006/-0.000</b>	<b>+0.000/-0.004</b>	<b>+0.000/-0.004</b>	<b>+0.000/-0.006</b>	<b>+0.004/-0.000</b>	<b>+0.004/-0.000</b>	<b>+0.010/-0.000</b>	
8.000	7.749	7.975	7.750	8.001	7.775	D = W + 0.010"	4650WN125-08000-XXXX
8.250	7.999	8.225	8.000	8.251	8.025	D = W + 0.010"	4650WN125-08250-XXXX
8.500	8.249	8.475	8.250	8.501	8.275	D = W + 0.010"	4650WN125-08500-XXXX
8.750	8.499	8.725	8.500	8.751	8.525	D = W + 0.010"	4650WN125-08750-XXXX
9.000	8.749	8.975	8.750	9.001	8.775	D = W + 0.010"	4650WN125-09000-XXXX
9.250	8.999	9.225	9.000	9.251	9.025	D = W + 0.010"	4650WN125-09250-XXXX
9.500	9.249	9.475	9.250	9.501	9.275	D = W + 0.010"	4650WN125-09500-XXXX
10.000	9.749	9.975	9.750	10.001	9.775	D = W + 0.010"	4650WN125-10000-XXXX
10.500	10.249	10.475	10.250	10.501	10.275	D = W + 0.010"	4650WN125-10500-XXXX
10.625	10.374	10.600	10.375	10.626	10.400	D = W + 0.010"	4650WN125-10625-XXXX
11.000	10.749	10.975	10.750	11.001	10.775	D = W + 0.010"	4650WN125-11000-XXXX
11.500	11.249	11.475	11.250	11.501	11.275	D = W + 0.010"	4650WN125-11500-XXXX
12.000	11.749	11.975	11.750	12.001	11.775	D = W + 0.010"	4650WN125-12000-XXXX

For custom groove calculations, see Appendix C.

NOTE: For sizes larger than those shown in the table, please contact your local Parker Seal representative.

## WN Groove Calculation

See Piston and Rod Wear Ring Groove Calculations in Appendix C.



# Wear Ring / Bearing PDT Profile

Catalog EPS 5370/USA



## PDT Profile, PTFE Wear Strip for Rod and Piston

PDT wear strip is available in a variety of PTFE blends and provides excellent low-friction performance in pneumatics and light-duty hydraulics. PDTs are available in cut-to-length versions as well as bulk strip. Cut-to-length part numbers reduce prep time by providing precision end cuts and ready-to-install diameters. Bulk strip PDTs offer versatility and reduce part number inventory by providing universal sizing in one part number.

## Technical Data

### Standard Material

0401 – 40% Bronze-Filled PTFE  
0307 – 23% Carbon, 2% Graphite-Filled PTFE  
Others available upon request

### Radial Tolerance

+.000"/-.004"

### End Cuts

Butt Cut, Angle Cut, Step Cut

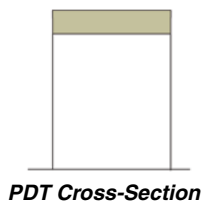

PDT Cross-Section

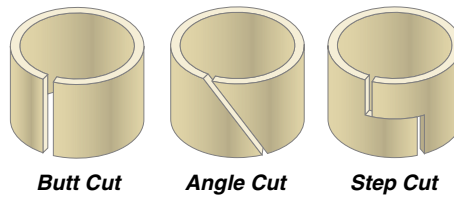

Butt Cut

Angle Cut

Step Cut

### Options

Virtually any width, diameter and cross-section can be produced without assessing a setup charge.



Piston sealing system comprised of PDT wear strip and B7 piston u-cups

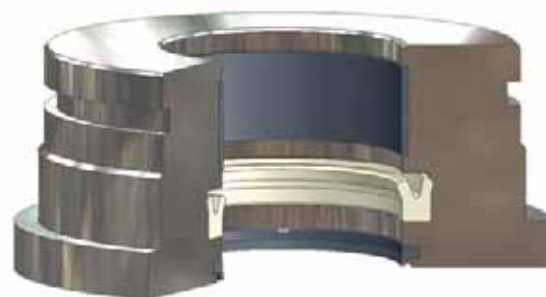

Rod sealing system comprised of PDT wear strip, B3 rod u-cup and SH959 wiper

09/01/07

**Part Number Nomenclature — PDT Profile**

**Table 9-11. PDT Profile — Cut-to-Length**

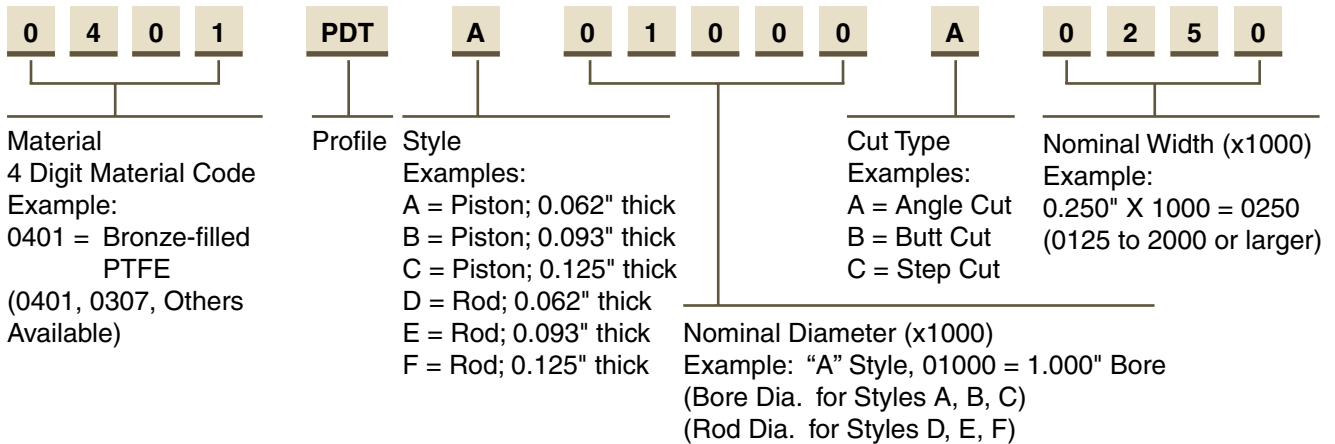

**Table 9-12. PDT Profile — Bulk Strip**

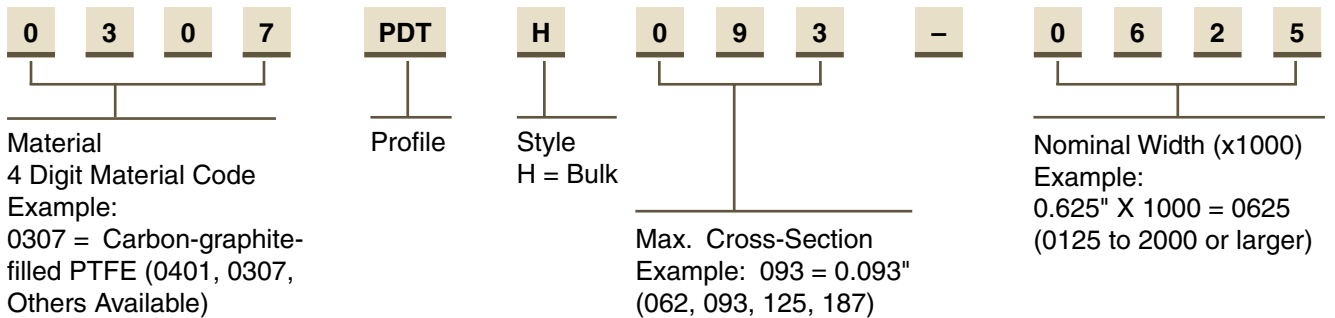

**Gland Dimensions — PDT Profile, Piston (Cut-To-Length)**

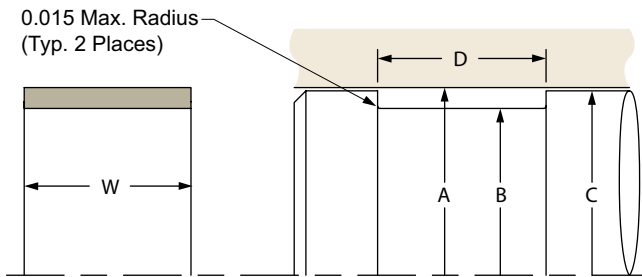

Please refer to Engineering Section 2, page 2-8 for surface finish and additional hardware considerations.

**Table 9-13. PDT Gland Dimensions (Piston, Cut-To-Length) — Inch**

A Bore Diameter	B Groove Diameter	C Piston Diameter	D Groove Width	Part Number
+0.002/-0.000	+0.000/-0.002	+0.000/-0.002	+0.010/-0.000	PDTA
1.000	0.875	0.979	D = W + 0.010"	XXXX PDTA 01000 X XXXX
1.062	0.937	1.041	D = W + 0.010"	XXXX PDTA 01062 X XXXX
1.125	1.000	1.104	D = W + 0.010"	XXXX PDTA 01125 X XXXX
1.187	1.062	1.166	D = W + 0.010"	XXXX PDTA 01187 X XXXX
1.250	1.125	1.229	D = W + 0.010"	XXXX PDTA 01250 X XXXX

For custom groove calculations, see Appendix C.



**PDT Profile**

**Table 9-13. PDT Gland Dimensions (Piston, Cut-To-Length) — Inch (Continued)**

A Bore Diameter	B Groove Diameter	C Piston Diameter	D Groove Width	Part Number
<b>+ .002/- .000</b>	<b>+ .000/- .002</b>	<b>+ .000/- .002</b>	<b>+ .010/- .000</b>	<b>PDTA</b>
1.312	1.187	1.291	D = W + 0.010"	XXXX PDTA 01312 X XXXX
1.375	1.250	1.354	D = W + 0.010"	XXXX PDTA 01375 X XXXX
1.437	1.312	1.416	D = W + 0.010"	XXXX PDTA 01437 X XXXX
1.500	1.375	1.479	D = W + 0.010"	XXXX PDTA 01500 X XXXX
1.562	1.437	1.541	D = W + 0.010"	XXXX PDTA 01562 X XXXX
1.625	1.500	1.604	D = W + 0.010"	XXXX PDTA 01625 X XXXX
1.687	1.562	1.666	D = W + 0.010"	XXXX PDTA 01687 X XXXX
1.750	1.625	1.729	D = W + 0.010"	XXXX PDTA 01750 X XXXX
1.875	1.750	1.854	D = W + 0.010"	XXXX PDTA 01875 X XXXX
2.000	1.875	1.979	D = W + 0.010"	XXXX PDTA 02000 X XXXX
<b>+ .002/- .000</b>	<b>+ .000/- .002</b>	<b>+ .000/- .002</b>	<b>+ .010/- .000</b>	<b>PDTB</b>
1.500	1.313	1.479	D = W + 0.010"	XXXX PDTB 01500 X XXXX
1.562	1.375	1.541	D = W + 0.010"	XXXX PDTB 01562 X XXXX
1.625	1.438	1.604	D = W + 0.010"	XXXX PDTB 01625 X XXXX
1.687	1.500	1.666	D = W + 0.010"	XXXX PDTB 01687 X XXXX
1.750	1.563	1.729	D = W + 0.010"	XXXX PDTB 01750 X XXXX
1.875	1.688	1.854	D = W + 0.010"	XXXX PDTB 01875 X XXXX
2.000	1.813	1.979	D = W + 0.010"	XXXX PDTB 02000 X XXXX
2.125	1.938	2.104	D = W + 0.010"	XXXX PDTB 02125 X XXXX
2.250	2.063	2.229	D = W + 0.010"	XXXX PDTB 02250 X XXXX
2.375	2.188	2.354	D = W + 0.010"	XXXX PDTB 02375 X XXXX
2.500	2.313	2.479	D = W + 0.010"	XXXX PDTB 02500 X XXXX
2.625	2.438	2.604	D = W + 0.010"	XXXX PDTB 02625 X XXXX
2.750	2.563	2.729	D = W + 0.010"	XXXX PDTB 02750 X XXXX
2.875	2.688	2.854	D = W + 0.010"	XXXX PDTB 02875 X XXXX
3.000	2.813	2.979	D = W + 0.010"	XXXX PDTB 03000 X XXXX
3.125	2.938	3.104	D = W + 0.010"	XXXX PDTB 03125 X XXXX
3.250	3.063	3.229	D = W + 0.010"	XXXX PDTB 03250 X XXXX
3.375	3.188	3.354	D = W + 0.010"	XXXX PDTB 03375 X XXXX
3.500	3.313	3.479	D = W + 0.010"	XXXX PDTB 03500 X XXXX
3.625	3.438	3.604	D = W + 0.010"	XXXX PDTB 03625 X XXXX
3.750	3.563	3.729	D = W + 0.010"	XXXX PDTB 03750 X XXXX
3.875	3.688	3.854	D = W + 0.010"	XXXX PDTB 03875 X XXXX
4.000	3.813	3.979	D = W + 0.010"	XXXX PDTB 04000 X XXXX
4.125	3.938	4.104	D = W + 0.010"	XXXX PDTB 04125 X XXXX
4.250	4.063	4.229	D = W + 0.010"	XXXX PDTB 04250 X XXXX
4.375	4.188	4.354	D = W + 0.010"	XXXX PDTB 04375 X XXXX
4.500	4.313	4.479	D = W + 0.010"	XXXX PDTB 04500 X XXXX
4.625	4.438	4.604	D = W + 0.010"	XXXX PDTB 04625 X XXXX
4.750	4.563	4.729	D = W + 0.010"	XXXX PDTB 04750 X XXXX
4.875	4.688	4.854	D = W + 0.010"	XXXX PDTB 04875 X XXXX
<b>+ .004/- .000</b>	<b>+ .000/- .003</b>	<b>+ .000/- .003</b>	<b>+ .010/- .000</b>	<b>PDTB</b>
5.000	4.813	4.978	D = W + 0.010"	XXXX PDTB 05000 X XXXX
5.125	4.938	5.103	D = W + 0.010"	XXXX PDTB 05125 X XXXX

For custom groove calculations, see Appendix C.

09/01/07



Table 9-13. PDT Gland Dimensions (Piston, Cut-To-Length) — Inch (Continued)

A Bore Diameter	B Groove Diameter	C Piston Diameter	D Groove Width	Part Number
<b>+ .004/- .000</b>	<b>+ .000/- .003</b>	<b>+ .000/- .003</b>	<b>+ .010/- .000</b>	<b>PDTB</b>
5.250	5.063	5.228	D = W + 0.010"	XXXX PDTB 05250 X XXXX
5.375	5.188	5.353	D = W + 0.010"	XXXX PDTB 05375 X XXXX
5.500	5.313	5.478	D = W + 0.010"	XXXX PDTB 05500 X XXXX
5.625	5.438	5.603	D = W + 0.010"	XXXX PDTB 05625 X XXXX
5.750	5.563	5.728	D = W + 0.010"	XXXX PDTB 05750 X XXXX
5.875	5.688	5.853	D = W + 0.010"	XXXX PDTB 05875 X XXXX
6.000	5.813	5.978	D = W + 0.010"	XXXX PDTB 06000 X XXXX
6.125	5.938	6.103	D = W + 0.010"	XXXX PDTB 06125 X XXXX
6.250	6.063	6.228	D = W + 0.010"	XXXX PDTB 06250 X XXXX
6.375	6.188	6.353	D = W + 0.010"	XXXX PDTB 06375 X XXXX
6.500	6.313	6.478	D = W + 0.010"	XXXX PDTB 06500 X XXXX
6.750	6.563	6.728	D = W + 0.010"	XXXX PDTB 06750 X XXXX
7.000	6.813	6.978	D = W + 0.010"	XXXX PDTB 07000 X XXXX
7.250	7.063	7.228	D = W + 0.010"	XXXX PDTB 07250 X XXXX
7.500	7.313	7.478	D = W + 0.010"	XXXX PDTB 07500 X XXXX
7.750	7.563	7.728	D = W + 0.010"	XXXX PDTB 07750 X XXXX
<b>+ .006/- .000</b>	<b>+ .000/- .004</b>	<b>+ .000/- .004</b>	<b>+ .010/- .000</b>	<b>PDTB</b>
8.000	7.813	7.977	D = W + 0.010"	XXXX PDTB 08000 X XXXX
8.250	8.063	8.227	D = W + 0.010"	XXXX PDTB 08250 X XXXX
8.500	8.313	8.477	D = W + 0.010"	XXXX PDTB 08500 X XXXX
9.000	8.813	8.977	D = W + 0.010"	XXXX PDTB 09000 X XXXX
9.500	9.313	9.477	D = W + 0.010"	XXXX PDTB 09500 X XXXX
10.000	9.813	9.977	D = W + 0.010"	XXXX PDTB 10000 X XXXX
<b>+ .002/- .000</b>	<b>+ .000/- .002</b>	<b>+ .000/- .002</b>	<b>+ .010/- .000</b>	<b>PDTC</b>
2.000	1.749	1.979	D = W + 0.010"	XXXX PDTC 02000 X XXXX
2.125	1.874	2.104	D = W + 0.010"	XXXX PDTC 02125 X XXXX
2.250	1.999	2.229	D = W + 0.010"	XXXX PDTC 02250 X XXXX
2.375	2.124	2.354	D = W + 0.010"	XXXX PDTC 02375 X XXXX
2.500	2.249	2.479	D = W + 0.010"	XXXX PDTC 02500 X XXXX
2.625	2.374	2.604	D = W + 0.010"	XXXX PDTC 02625 X XXXX
2.750	2.499	2.729	D = W + 0.010"	XXXX PDTC 02750 X XXXX
2.875	2.624	2.854	D = W + 0.010"	XXXX PDTC 02875 X XXXX
3.000	2.749	2.979	D = W + 0.010"	XXXX PDTC 03000 X XXXX
3.125	2.874	3.104	D = W + 0.010"	XXXX PDTC 03125 X XXXX
3.250	2.999	3.229	D = W + 0.010"	XXXX PDTC 03250 X XXXX
3.375	3.124	3.354	D = W + 0.010"	XXXX PDTC 03375 X XXXX
3.500	3.249	3.479	D = W + 0.010"	XXXX PDTC 03500 X XXXX
3.625	3.374	3.604	D = W + 0.010"	XXXX PDTC 03625 X XXXX
3.750	3.499	3.729	D = W + 0.010"	XXXX PDTC 03750 X XXXX
3.875	3.624	3.854	D = W + 0.010"	XXXX PDTC 03875 X XXXX
4.000	3.749	3.979	D = W + 0.010"	XXXX PDTC 04000 X XXXX
4.125	3.874	4.104	D = W + 0.010"	XXXX PDTC 04125 X XXXX
4.250	3.999	4.229	D = W + 0.010"	XXXX PDTC 04250 X XXXX
4.375	4.124	4.354	D = W + 0.010"	XXXX PDTC 04375 X XXXX

For custom groove calculations, see Appendix C.

09/01/07

**PDT Profile**

**Table 9-13. PDT Gland Dimensions (Piston, Cut-To-Length) — Inch (Continued)**

A Bore Diameter	B Groove Diameter	C Piston Diameter	D Groove Width	Part Number
<b>+ .002/- .000</b>	<b>+ .000/- .002</b>	<b>+ .000/- .002</b>	<b>+ .010/- .000</b>	<b>PDTC</b>
4.500	4.249	4.479	D = W + 0.010"	XXXX PDTC 04500 X XXXX
4.625	4.374	4.604	D = W + 0.010"	XXXX PDTC 04625 X XXXX
4.750	4.499	4.729	D = W + 0.010"	XXXX PDTC 04750 X XXXX
4.875	4.624	4.854	D = W + 0.010"	XXXX PDTC 04875 X XXXX
<b>+ .004/- .000</b>	<b>+ .000/- .003</b>	<b>+ .000/- .003</b>	<b>+ .010/- .000</b>	<b>PDTC</b>
5.000	4.749	4.978	D = W + 0.010"	XXXX PDTC 05000 X XXXX
5.125	4.874	5.103	D = W + 0.010"	XXXX PDTC 05125 X XXXX
5.250	4.999	5.228	D = W + 0.010"	XXXX PDTC 05250 X XXXX
5.375	5.124	5.353	D = W + 0.010"	XXXX PDTC 05375 X XXXX
5.500	5.249	5.478	D = W + 0.010"	XXXX PDTC 05500 X XXXX
5.625	5.374	5.603	D = W + 0.010"	XXXX PDTC 05625 X XXXX
5.750	5.499	5.728	D = W + 0.010"	XXXX PDTC 05750 X XXXX
5.875	5.624	5.853	D = W + 0.010"	XXXX PDTC 05875 X XXXX
6.000	5.749	5.978	D = W + 0.010"	XXXX PDTC 06000 X XXXX
6.125	5.874	6.103	D = W + 0.010"	XXXX PDTC 06125 X XXXX
6.250	5.999	6.228	D = W + 0.010"	XXXX PDTC 06250 X XXXX
6.375	6.124	6.353	D = W + 0.010"	XXXX PDTC 06375 X XXXX
6.500	6.249	6.478	D = W + 0.010"	XXXX PDTC 06500 X XXXX
6.750	6.499	6.728	D = W + 0.010"	XXXX PDTC 06750 X XXXX
7.000	6.749	6.978	D = W + 0.010"	XXXX PDTC 07000 X XXXX
7.250	6.999	7.228	D = W + 0.010"	XXXX PDTC 07250 X XXXX
7.500	7.249	7.478	D = W + 0.010"	XXXX PDTC 07500 X XXXX
7.750	7.499	7.728	D = W + 0.010"	XXXX PDTC 07750 X XXXX
<b>+ .006/- .000</b>	<b>+ .000/- .004</b>	<b>+ .000/- .004</b>	<b>+ .010/- .000</b>	<b>PDTC</b>
8.000	7.749	7.977	D = W + 0.010"	XXXX PDTC 08000 X XXXX
8.250	7.999	8.227	D = W + 0.010"	XXXX PDTC 08250 X XXXX
8.500	8.249	8.477	D = W + 0.010"	XXXX PDTC 08500 X XXXX
9.000	8.749	8.977	D = W + 0.010"	XXXX PDTC 09000 X XXXX
9.500	9.249	9.477	D = W + 0.010"	XXXX PDTC 09500 X XXXX
10.000	9.749	9.977	D = W + 0.010"	XXXX PDTC 10000 X XXXX
10.500	10.249	10.477	D = W + 0.010"	XXXX PDTC 10500 X XXXX
11.000	10.749	10.977	D = W + 0.010"	XXXX PDTC 11000 X XXXX
11.500	11.249	11.477	D = W + 0.010"	XXXX PDTC 11500 X XXXX
12.000	11.749	11.977	D = W + 0.010"	XXXX PDTC 12000 X XXXX
12.500	12.249	12.477	D = W + 0.010"	XXXX PDTC 12500 X XXXX
13.000	12.749	12.977	D = W + 0.010"	XXXX PDTC 13000 X XXXX
13.500	13.249	13.477	D = W + 0.010"	XXXX PDTC 13500 X XXXX
14.000	13.749	13.977	D = W + 0.010"	XXXX PDTC 14000 X XXXX
14.500	14.249	14.477	D = W + 0.010"	XXXX PDTC 14500 X XXXX
15.000	14.749	14.977	D = W + 0.010"	XXXX PDTC 15000 X XXXX
15.500	15.249	15.477	D = W + 0.010"	XXXX PDTC 15500 X XXXX
16.000	15.749	15.977	D = W + 0.010"	XXXX PDTC 16000 X XXXX

For custom groove calculations, see Appendix C.

NOTE: For sizes larger than those shown in the table, please contact your local Parker Seal representative.

09/01/07



## PDT Groove Calculation

See Piston and Rod Wear Ring Groove Calculations in Appendix C.

### Gland Dimensions — PDT Profile, Rod (Cut-To-Length)

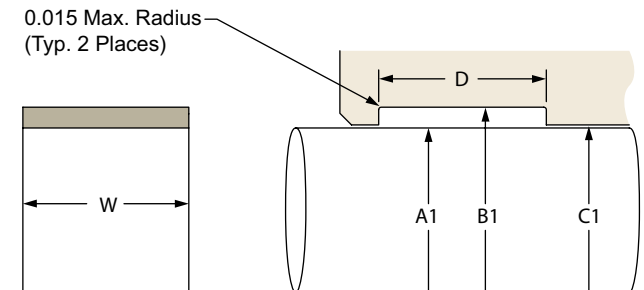

Please refer to Engineering Section 2, page 2-8 for surface finish and additional hardware considerations.

**Table 9-14. PDT Gland Dimensions (Rod, Cut-To-Length) — Inch**

A1 Rod Diameter	B1 Groove Diameter	C1 Piston Diameter	D Groove Width	Part Number
<b>+ .000/- .002</b>	<b>+ .002/- .000</b>	<b>+ .002/- .000</b>	<b>+ .010/- .000</b>	<b>PDTD</b>
0.875	1.000	0.896	D = W + 0.010"	XXXX PDTD 00875 X XXXX
0.937	1.062	0.958	D = W + 0.010"	XXXX PDTD 00937 X XXXX
1.000	1.125	1.021	D = W + 0.010"	XXXX PDTD 01000 X XXXX
1.062	1.187	1.083	D = W + 0.010"	XXXX PDTD 01062 X XXXX
1.125	1.250	1.146	D = W + 0.010"	XXXX PDTD 01125 X XXXX
1.187	1.312	1.208	D = W + 0.010"	XXXX PDTD 01187 X XXXX
1.250	1.375	1.271	D = W + 0.010"	XXXX PDTD 01250 X XXXX
1.312	1.437	1.333	D = W + 0.010"	XXXX PDTD 01312 X XXXX
1.375	1.500	1.396	D = W + 0.010"	XXXX PDTD 01375 X XXXX
1.437	1.562	1.458	D = W + 0.010"	XXXX PDTD 01437 X XXXX
1.500	1.625	1.521	D = W + 0.010"	XXXX PDTD 01500 X XXXX
1.625	1.750	1.646	D = W + 0.010"	XXXX PDTD 01625 X XXXX
1.750	1.875	1.771	D = W + 0.010"	XXXX PDTD 01750 X XXXX
1.875	2.000	1.896	D = W + 0.010"	XXXX PDTD 01875 X XXXX
2.000	2.125	2.021	D = W + 0.010"	XXXX PDTD 02000 X XXXX
<b>+ .000/- .002</b>	<b>+ .002/- .000</b>	<b>+ .002/- .000</b>	<b>+ .010/- .000</b>	<b>PDTE</b>
1.500	1.687	1.521	D = W + 0.010"	XXXX PDTE 01500 X XXXX
1.625	1.812	1.646	D = W + 0.010"	XXXX PDTE 01625 X XXXX
1.750	1.937	1.771	D = W + 0.010"	XXXX PDTE 01750 X XXXX
1.875	2.062	1.896	D = W + 0.010"	XXXX PDTE 01875 X XXXX
2.000	2.187	2.021	D = W + 0.010"	XXXX PDTE 02000 X XXXX
2.125	2.312	2.146	D = W + 0.010"	XXXX PDTE 02125 X XXXX
2.250	2.437	2.271	D = W + 0.010"	XXXX PDTE 02250 X XXXX
2.375	2.562	2.396	D = W + 0.010"	XXXX PDTE 02375 X XXXX
2.500	2.687	2.521	D = W + 0.010"	XXXX PDTE 02500 X XXXX
2.625	2.812	2.646	D = W + 0.010"	XXXX PDTE 02625 X XXXX
2.750	2.937	2.771	D = W + 0.010"	XXXX PDTE 02750 X XXXX
2.875	3.062	2.896	D = W + 0.010"	XXXX PDTE 02875 X XXXX
3.000	3.187	3.021	D = W + 0.010"	XXXX PDTE 03000 X XXXX

For custom groove calculations, see Appendix C.

09/01/07

9

**PDT Profile**

**Table 9-14. PDT Gland Dimensions (Rod, Cut-To-Length) — Inch (Continued)**

A1 Rod Diameter	B1 Groove Diameter	C1 Piston Diameter	D Groove Width	Part Number
<b>+ .000/- .002</b>	<b>+ .002/- .000</b>	<b>+ .002/- .000</b>	<b>+ .010/- .000</b>	<b>PDTE</b>
3.125	3.312	3.146	D = W + 0.010"	XXXX PDTE 03125 X XXXX
3.250	3.437	3.271	D = W + 0.010"	XXXX PDTE 03250 X XXXX
3.375	3.562	3.396	D = W + 0.010"	XXXX PDTE 03375 X XXXX
3.500	3.687	3.521	D = W + 0.010"	XXXX PDTE 03500 X XXXX
3.625	3.812	3.646	D = W + 0.010"	XXXX PDTE 03625 X XXXX
3.750	3.937	3.771	D = W + 0.010"	XXXX PDTE 03750 X XXXX
3.875	4.062	3.896	D = W + 0.010"	XXXX PDTE 03875 X XXXX
4.000	4.187	4.021	D = W + 0.010"	XXXX PDTE 04000 X XXXX
4.125	4.312	4.146	D = W + 0.010"	XXXX PDTE 04125 X XXXX
4.250	4.437	4.271	D = W + 0.010"	XXXX PDTE 04250 X XXXX
4.375	4.562	4.396	D = W + 0.010"	XXXX PDTE 04375 X XXXX
4.500	4.687	4.521	D = W + 0.010"	XXXX PDTE 04500 X XXXX
4.625	4.812	4.646	D = W + 0.010"	XXXX PDTE 04625 X XXXX
4.750	4.937	4.771	D = W + 0.010"	XXXX PDTE 04750 X XXXX
4.875	5.062	4.896	D = W + 0.010"	XXXX PDTE 04875 X XXXX
5.000	5.187	5.021	D = W + 0.010"	XXXX PDTE 05000 X XXXX
<b>+ .000/- .002</b>	<b>+ .002/- .000</b>	<b>+ .002/- .000</b>	<b>+ .010/- .000</b>	<b>PDTF</b>
1.500	1.751	1.521	D = W + 0.010"	XXXX PDTF 01500 X XXXX
1.625	1.876	1.646	D = W + 0.010"	XXXX PDTF 01625 X XXXX
1.750	2.001	1.771	D = W + 0.010"	XXXX PDTF 01750 X XXXX
1.875	2.126	1.896	D = W + 0.010"	XXXX PDTF 01875 X XXXX
2.000	2.251	2.021	D = W + 0.010"	XXXX PDTF 02000 X XXXX
2.125	2.376	2.146	D = W + 0.010"	XXXX PDTF 02125 X XXXX
2.250	2.501	2.271	D = W + 0.010"	XXXX PDTF 02250 X XXXX
2.375	2.626	2.396	D = W + 0.010"	XXXX PDTF 02375 X XXXX
2.500	2.751	2.521	D = W + 0.010"	XXXX PDTF 02500 X XXXX
2.625	2.876	2.646	D = W + 0.010"	XXXX PDTF 02625 X XXXX
2.750	3.001	2.771	D = W + 0.010"	XXXX PDTF 02750 X XXXX
2.875	3.126	2.896	D = W + 0.010"	XXXX PDTF 02875 X XXXX
3.000	3.251	3.021	D = W + 0.010"	XXXX PDTF 03000 X XXXX
3.125	3.376	3.146	D = W + 0.010"	XXXX PDTF 03125 X XXXX
<b>+ .000/- .002</b>	<b>+ .002/- .000</b>	<b>+ .002/- .000</b>	<b>+ .010/- .000</b>	<b>PDTF</b>
3.250	3.501	3.271	D = W + 0.010"	XXXX PDTF 03250 X XXXX
3.375	3.626	3.396	D = W + 0.010"	XXXX PDTF 03375 X XXXX
3.500	3.751	3.521	D = W + 0.010"	XXXX PDTF 03500 X XXXX
3.625	3.876	3.646	D = W + 0.010"	XXXX PDTF 03625 X XXXX
3.750	4.001	3.771	D = W + 0.010"	XXXX PDTF 03750 X XXXX
3.875	4.126	3.896	D = W + 0.010"	XXXX PDTF 03875 X XXXX
4.000	4.251	4.021	D = W + 0.010"	XXXX PDTF 04000 X XXXX
4.125	4.376	4.146	D = W + 0.010"	XXXX PDTF 04125 X XXXX
4.250	4.501	4.271	D = W + 0.010"	XXXX PDTF 04250 X XXXX
4.375	4.626	4.396	D = W + 0.010"	XXXX PDTF 04375 X XXXX
4.500	4.751	4.521	D = W + 0.010"	XXXX PDTF 04500 X XXXX
4.625	4.876	4.646	D = W + 0.010"	XXXX PDTF 04625 X XXXX

For custom groove calculations, see Appendix C.

09/01/07



Table 9-14. PDT Gland Dimensions (Rod, Cut-To-Length) — Inch (Continued)

A1 Rod Diameter	B1 Groove Diameter	C1 Piston Diameter	D Groove Width	Part Number
<b>+.000/-.004</b>	<b>+.003/-.000</b>	<b>+.003/-.000</b>	<b>+.010/-.000</b>	<b>PDTF</b>
4.750	5.001	4.772	D = W + 0.010"	XXXX PDTF 04750 X XXXX
4.875	5.126	4.897	D = W + 0.010"	XXXX PDTF 04875 X XXXX
5.000	5.251	5.022	D = W + 0.010"	XXXX PDTF 05000 X XXXX
5.125	5.376	5.147	D = W + 0.010"	XXXX PDTF 05125 X XXXX
5.250	5.501	5.272	D = W + 0.010"	XXXX PDTF 05250 X XXXX
5.375	5.626	5.397	D = W + 0.010"	XXXX PDTF 05375 X XXXX
5.500	5.751	5.522	D = W + 0.010"	XXXX PDTF 05500 X XXXX
5.625	5.876	5.647	D = W + 0.010"	XXXX PDTF 05625 X XXXX
5.750	6.001	5.772	D = W + 0.010"	XXXX PDTF 05750 X XXXX
5.875	6.126	5.897	D = W + 0.010"	XXXX PDTF 05875 X XXXX
6.000	6.251	6.022	D = W + 0.010"	XXXX PDTF 06000 X XXXX
6.250	6.501	6.272	D = W + 0.010"	XXXX PDTF 06250 X XXXX
6.500	6.751	6.522	D = W + 0.010"	XXXX PDTF 06500 X XXXX
6.750	7.001	6.772	D = W + 0.010"	XXXX PDTF 06750 X XXXX
7.000	7.251	7.022	D = W + 0.010"	XXXX PDTF 07000 X XXXX
7.250	7.501	7.272	D = W + 0.010"	XXXX PDTF 07250 X XXXX
7.500	7.751	7.522	D = W + 0.010"	XXXX PDTF 07500 X XXXX
<b>+.000/-.006</b>	<b>+.004/-.000</b>	<b>+.004/-.000</b>	<b>+.010/-.000</b>	<b>PDTF</b>
7.750	8.001	7.773	D = W + 0.010"	XXXX PDTF 07750 X XXXX
8.000	8.251	8.023	D = W + 0.010"	XXXX PDTF 08000 X XXXX
8.500	8.751	8.523	D = W + 0.010"	XXXX PDTF 08500 X XXXX
9.000	9.251	9.023	D = W + 0.010"	XXXX PDTF 09000 X XXXX
9.500	9.751	9.523	D = W + 0.010"	XXXX PDTF 09500 X XXXX
10.000	10.251	10.023	D = W + 0.010"	XXXX PDTF 10000 X XXXX

For custom groove calculations, see Appendix C.

NOTE: For sizes larger than those shown in the table, please contact your local Parker Seal representative.

## PDT Rod Groove Calculation

See Rod Wear Ring Groove Calculation in Appendix C.

# PDT Profile

## PDT Bulk Strip

Table 9-15. PDT Bulk Strip Standard Sizes

T Radial Cross-Section	W Width	Part Number
<b>062</b>		
0.062	0.250	XXXX PDTH 062-0250
0.062	0.375	XXXX PDTH 062-0375
0.062	0.500	XXXX PDTH 062-0500
0.062	0.625	XXXX PDTH 062-0625
<b>093</b>		
0.093	0.250	XXXX PDTH 093-0250
0.093	0.375	XXXX PDTH 093-0375
0.093	0.500	XXXX PDTH 093-0500
0.093	0.625	XXXX PDTH 093-0625
<b>125</b>		
0.125	0.250	XXXX PDTH 125-0250
0.125	0.375	XXXX PDTH 125-0375
0.125	0.500	XXXX PDTH 125-0500
0.125	0.625	XXXX PDTH 125-0625
0.125	0.750	XXXX PDTH 125-0750
0.125	1.000	XXXX PDTH 125-1000

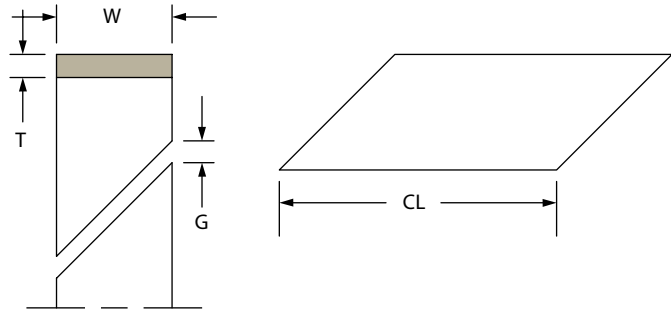

NOTE: For sizes larger than those shown in the table, please contact your local Parker Seal representative.

## Cutting Instructions

Table 9-16. Recommended Cutting Instructions

Rod or Bore Diameter	G Minimum Gap	CL ± Tolerance for Cut Length
0.500" - 1.750"	0.075	± .010
1.751" - 3.125"	0.140	± .016
3.126" - 4.000"	0.175	± .024
4.001" - 5.000"	0.230	± .032
5.001" - 6.000"	0.260	± .040
6.001" - 7.000"	0.320	± .047
7.001" - 8.500"	0.380	± .055
8.501" - 10.500"	0.480	± .063
10.501" - 13.000"	0.620	± .071
13.001" - 16.000"	0.750	± .079

NOTE: For sizes larger than those shown in the table, please contact your local Parker Seal representative.

## Formula for Calculating Cut Length, CL

For Pistons:

$$CL = [(Bore Diameter - T) \times \pi] - G$$

For Rods:

$$CL = [(Rod Diameter + T) \times \pi] - G$$

To calculate groove dimensions, use either the pre-established values or the formulas for cut-to-length PDT strip found on Pages 9-23 and 9-26.



09/01/07

# Wear Ring / Bearing PDW Profile

Catalog EPS 5370/USA



## PDW Profile, Machined Wear Ring for Rod and Piston

PDW wear rings are precision machined PTFE bearings, lathe cut to exact size and shape. PDWs offer precise fitting and easy installation. The wide range of available PTFE blends gives these machined wear rings versatility to accommodate any pneumatic or light-duty hydraulic application requiring low friction and high temperature capabilities.

### Technical Data

#### Standard Material

0401 – 40% Bronze-Filled PTFE

0307 – 23% Carbon, 2% Graphite-Filled PTFE

Others available upon request

#### Radial Tolerance

+ .000" / - .004"

#### End Cuts

Butt Cut, Angle Cut, Step Cut

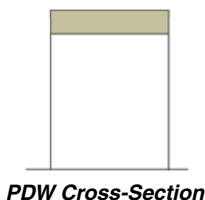

PDW Cross-Section

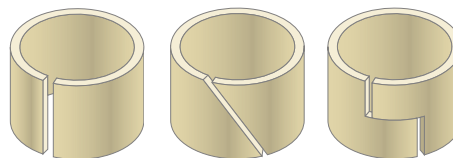

Butt Cut

Angle Cut

Step Cut

#### Options

Virtually any width, diameter and cross-section can be produced without assessing a setup charge.



*Piston sealing system comprised of PDW machined wear rings and E4 piston u-cups*

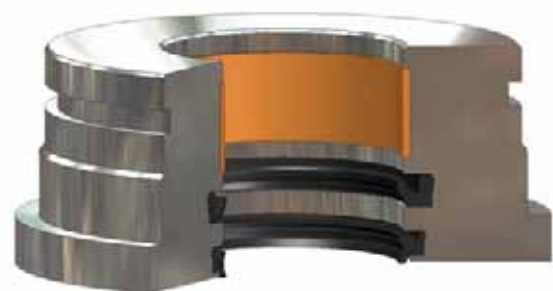

*Rod sealing system comprised of PDW machined wear ring, E5 u-cup and 8600 wiper*

09/01/07

# PDW Profile

## Part Number Nomenclature — PDW Profile

Table 9-17. PDW Profile

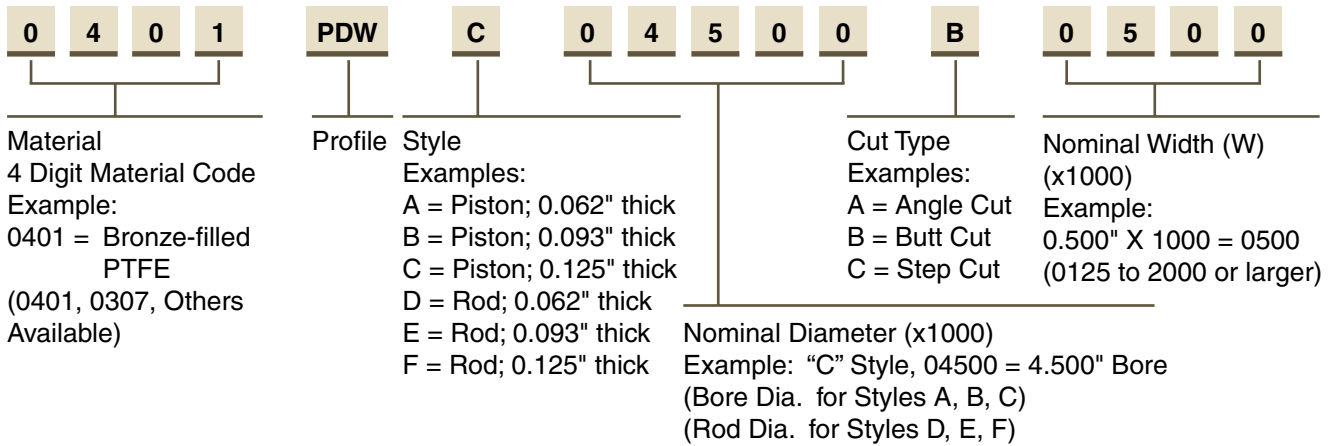

## Gland Dimensions — PDW Profile, Piston

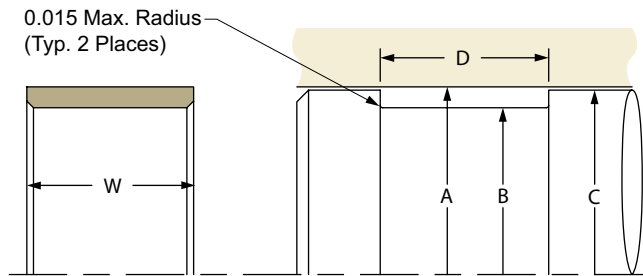

Please refer to Engineering Section 2, page 2-8 for surface finish and additional hardware considerations.

Table 9-18. PDW Gland Dimensions (Piston) — Inch

A Bore Diameter +.002/-.000	B Groove Diameter +.000/-.002	C Piston Diameter +.000/-.002	D Groove Width +.010/-.000	Part Number PDWA
0.687	0.562	0.666	D = W + 0.010"	XXXX PDWA 00687 X XXXX
0.750	0.625	0.729	D = W + 0.010"	XXXX PDWA 00750 X XXXX
0.812	0.687	0.791	D = W + 0.010"	XXXX PDWA 00812 X XXXX
0.875	0.750	0.854	D = W + 0.010"	XXXX PDWA 00875 X XXXX
0.937	0.812	0.916	D = W + 0.010"	XXXX PDWA 00937 X XXXX
1.000	0.875	0.979	D = W + 0.010"	XXXX PDWA 01000 X XXXX
1.062	0.937	1.041	D = W + 0.010"	XXXX PDWA 01062 X XXXX
1.125	1.000	1.104	D = W + 0.010"	XXXX PDWA 01125 X XXXX
1.187	1.062	1.166	D = W + 0.010"	XXXX PDWA 01187 X XXXX
1.250	1.125	1.229	D = W + 0.010"	XXXX PDWA 01250 X XXXX
1.312	1.187	1.291	D = W + 0.010"	XXXX PDWA 01312 X XXXX
1.375	1.250	1.354	D = W + 0.010"	XXXX PDWA 01375 X XXXX
1.437	1.312	1.416	D = W + 0.010"	XXXX PDWA 01437 X XXXX
1.500	1.375	1.479	D = W + 0.010"	XXXX PDWA 01500 X XXXX
1.562	1.437	1.541	D = W + 0.010"	XXXX PDWA 01562 X XXXX
1.625	1.500	1.604	D = W + 0.010"	XXXX PDWA 01625 X XXXX
1.687	1.562	1.666	D = W + 0.010"	XXXX PDWA 01687 X XXXX

For custom groove calculations, see Appendix C.

Table 9-18. PDW Gland Dimensions (Piston) — Inch (Continued)

A Bore Diameter	B Groove Diameter	C Piston Diameter	D Groove Width	Part Number
<b>+ .002/- .000</b>	<b>+ .000/- .002</b>	<b>+ .000/- .002</b>	<b>+ .010/- .000</b>	<b>PDWA</b>
1.750	1.625	1.729	D = W + 0.010"	XXXX PDWA 01750 X XXXX
1.875	1.750	1.854	D = W + 0.010"	XXXX PDWA 01875 X XXXX
2.000	1.875	1.979	D = W + 0.010"	XXXX PDWA 02000 X XXXX
<b>+ .002/- .000</b>	<b>+ .000/- .002</b>	<b>+ .000/- .002</b>	<b>+ .010/- .000</b>	<b>PDWB</b>
1.500	1.313	1.479	D = W + 0.010"	XXXX PDWB 01500 X XXXX
1.562	1.375	1.541	D = W + 0.010"	XXXX PDWB 01562 X XXXX
1.625	1.438	1.604	D = W + 0.010"	XXXX PDWB 01625 X XXXX
1.687	1.500	1.666	D = W + 0.010"	XXXX PDWB 01687 X XXXX
1.750	1.563	1.729	D = W + 0.010"	XXXX PDWB 01750 X XXXX
1.875	1.688	1.854	D = W + 0.010"	XXXX PDWB 01875 X XXXX
2.000	1.813	1.979	D = W + 0.010"	XXXX PDWB 02000 X XXXX
2.125	1.938	2.104	D = W + 0.010"	XXXX PDWB 02125 X XXXX
2.250	2.063	2.229	D = W + 0.010"	XXXX PDWB 02250 X XXXX
2.375	2.188	2.354	D = W + 0.010"	XXXX PDWB 02375 X XXXX
2.500	2.313	2.479	D = W + 0.010"	XXXX PDWB 02500 X XXXX
2.625	2.438	2.604	D = W + 0.010"	XXXX PDWB 02625 X XXXX
2.750	2.563	2.729	D = W + 0.010"	XXXX PDWB 02750 X XXXX
2.875	2.688	2.854	D = W + 0.010"	XXXX PDWB 02875 X XXXX
3.000	2.813	2.979	D = W + 0.010"	XXXX PDWB 03000 X XXXX
3.125	2.938	3.104	D = W + 0.010"	XXXX PDWB 03125 X XXXX
3.250	3.063	3.229	D = W + 0.010"	XXXX PDWB 03250 X XXXX
3.375	3.188	3.354	D = W + 0.010"	XXXX PDWB 03375 X XXXX
3.500	3.313	3.479	D = W + 0.010"	XXXX PDWB 03500 X XXXX
3.625	3.438	3.604	D = W + 0.010"	XXXX PDWB 03625 X XXXX
3.750	3.563	3.729	D = W + 0.010"	XXXX PDWB 03750 X XXXX
3.875	3.688	3.854	D = W + 0.010"	XXXX PDWB 03875 X XXXX
4.000	3.813	3.979	D = W + 0.010"	XXXX PDWB 04000 X XXXX
4.125	3.938	4.104	D = W + 0.010"	XXXX PDWB 04125 X XXXX
4.250	4.063	4.229	D = W + 0.010"	XXXX PDWB 04250 X XXXX
4.375	4.188	4.354	D = W + 0.010"	XXXX PDWB 04375 X XXXX
4.500	4.313	4.479	D = W + 0.010"	XXXX PDWB 04500 X XXXX
4.625	4.438	4.604	D = W + 0.010"	XXXX PDWB 04625 X XXXX
4.750	4.563	4.729	D = W + 0.010"	XXXX PDWB 04750 X XXXX
4.875	4.688	4.854	D = W + 0.010"	XXXX PDWB 04875 X XXXX
5.000	4.813	4.978	D = W + 0.010"	XXXX PDWB 05000 X XXXX
5.125	4.938	5.103	D = W + 0.010"	XXXX PDWB 05125 X XXXX
5.250	5.063	5.228	D = W + 0.010"	XXXX PDWB 05250 X XXXX
5.375	5.188	5.353	D = W + 0.010"	XXXX PDWB 05375 X XXXX
5.500	5.313	5.478	D = W + 0.010"	XXXX PDWB 05500 X XXXX
5.625	5.438	5.603	D = W + 0.010"	XXXX PDWB 05625 X XXXX
5.750	5.563	5.728	D = W + 0.010"	XXXX PDWB 05750 X XXXX
5.875	5.688	5.853	D = W + 0.010"	XXXX PDWB 05875 X XXXX
6.000	5.813	5.978	D = W + 0.010"	XXXX PDWB 06000 X XXXX

For custom groove calculations, see Appendix C.

09/01/07

9

**PDW Profile**

**Table 9-18. PDW Gland Dimensions (Piston) — Inch (Continued)**

A Bore Diameter	B Groove Diameter	C Piston Diameter	D Groove Width	Part Number
<b>+ .002/- .000</b>	<b>+ .000/- .002</b>	<b>+ .000/- .002</b>	<b>+ .010/- .000</b>	<b>PDWB</b>
6.125	5.938	6.103	D = W + 0.010"	XXXX PDWB 06125 X XXXX
6.250	6.063	6.228	D = W + 0.010"	XXXX PDWB 06250 X XXXX
6.375	6.188	6.353	D = W + 0.010"	XXXX PDWB 06375 X XXXX
6.500	6.313	6.478	D = W + 0.010"	XXXX PDWB 06500 X XXXX
6.750	6.563	6.728	D = W + 0.010"	XXXX PDWB 06750 X XXXX
7.000	6.813	6.978	D = W + 0.010"	XXXX PDWB 07000 X XXXX
7.250	7.063	7.228	D = W + 0.010"	XXXX PDWB 07250 X XXXX
7.500	7.313	7.478	D = W + 0.010"	XXXX PDWB 07500 X XXXX
7.750	7.563	7.728	D = W + 0.010"	XXXX PDWB 07750 X XXXX
<b>+ .006/- .000</b>	<b>+ .000/- .004</b>	<b>+ .000/- .004</b>	<b>+ .010/- .000</b>	<b>PDWB</b>
8.000	7.813	7.977	D = W + 0.010"	XXXX PDWB 08000 X XXXX
8.250	8.063	8.227	D = W + 0.010"	XXXX PDWB 08250 X XXXX
8.500	8.313	8.477	D = W + 0.010"	XXXX PDWB 08500 X XXXX
9.000	8.813	8.977	D = W + 0.010"	XXXX PDWB 09000 X XXXX
9.500	9.313	9.477	D = W + 0.010"	XXXX PDWB 09500 X XXXX
10.000	9.813	9.977	D = W + 0.010"	XXXX PDWB 10000 X XXXX
<b>+ .002/- .000</b>	<b>+ .000/- .002</b>	<b>+ .000/- .002</b>	<b>+ .010/- .000</b>	<b>PDWC</b>
2.000	1.749	1.979	D = W + 0.010"	XXXX PDWC 02000 X XXXX
2.125	1.874	2.104	D = W + 0.010"	XXXX PDWC 02125 X XXXX
2.250	1.999	2.229	D = W + 0.010"	XXXX PDWC 02250 X XXXX
2.375	2.124	2.354	D = W + 0.010"	XXXX PDWC 02375 X XXXX
2.500	2.249	2.479	D = W + 0.010"	XXXX PDWC 02500 X XXXX
2.625	2.374	2.604	D = W + 0.010"	XXXX PDWC 02625 X XXXX
2.750	2.499	2.729	D = W + 0.010"	XXXX PDWC 02750 X XXXX
2.875	2.624	2.854	D = W + 0.010"	XXXX PDWC 02875 X XXXX
3.000	2.749	2.979	D = W + 0.010"	XXXX PDWC 03000 X XXXX
3.125	2.874	3.104	D = W + 0.010"	XXXX PDWC 03125 X XXXX
3.250	2.999	3.229	D = W + 0.010"	XXXX PDWC 03250 X XXXX
3.375	3.124	3.354	D = W + 0.010"	XXXX PDWC 03375 X XXXX
3.500	3.249	3.479	D = W + 0.010"	XXXX PDWC 03500 X XXXX
3.625	3.374	3.604	D = W + 0.010"	XXXX PDWC 03625 X XXXX
3.750	3.499	3.729	D = W + 0.010"	XXXX PDWC 03750 X XXXX
3.875	3.624	3.854	D = W + 0.010"	XXXX PDWC 03875 X XXXX
4.000	3.749	3.979	D = W + 0.010"	XXXX PDWC 04000 X XXXX
4.125	3.874	4.104	D = W + 0.010"	XXXX PDWC 04125 X XXXX
4.250	3.999	4.229	D = W + 0.010"	XXXX PDWC 04250 X XXXX
4.375	4.124	4.354	D = W + 0.010"	XXXX PDWC 04375 X XXXX
4.500	4.249	4.479	D = W + 0.010"	XXXX PDWC 04500 X XXXX
4.625	4.374	4.604	D = W + 0.010"	XXXX PDWC 04625 X XXXX
4.750	4.499	4.729	D = W + 0.010"	XXXX PDWC 04750 X XXXX
4.875	4.624	4.854	D = W + 0.010"	XXXX PDWC 04875 X XXXX
5.000	4.749	4.978	D = W + 0.010"	XXXX PDWC 05000 X XXXX
5.125	4.874	5.103	D = W + 0.010"	XXXX PDWC 05125 X XXXX

For custom groove calculations, see Appendix C.

09/01/07



Table 9-18. PDW Gland Dimensions (Piston) — Inch (Continued)

A Bore Diameter	B Groove Diameter	C Piston Diameter	D Groove Width	Part Number
+ .004/- .000	+ .000/- .003	+ .000/- .003	+ .010/- .000	PDWC
5.250	4.999	5.228	D = W + 0.010"	XXXX PDWC 05250 X XXXX
5.375	5.124	5.353	D = W + 0.010"	XXXX PDWC 05375 X XXXX
5.500	5.249	5.478	D = W + 0.010"	XXXX PDWC 05500 X XXXX
5.625	5.374	5.603	D = W + 0.010"	XXXX PDWC 05625 X XXXX
5.750	5.499	5.728	D = W + 0.010"	XXXX PDWC 05750 X XXXX
5.875	5.624	5.853	D = W + 0.010"	XXXX PDWC 05875 X XXXX
6.000	5.749	5.978	D = W + 0.010"	XXXX PDWC 06000 X XXXX
6.125	5.874	6.103	D = W + 0.010"	XXXX PDWC 06125 X XXXX
6.250	5.999	6.228	D = W + 0.010"	XXXX PDWC 06250 X XXXX
6.375	6.124	6.353	D = W + 0.010"	XXXX PDWC 06375 X XXXX
6.500	6.249	6.478	D = W + 0.010"	XXXX PDWC 06500 X XXXX
6.750	6.499	6.728	D = W + 0.010"	XXXX PDWC 06750 X XXXX
7.000	6.749	6.978	D = W + 0.010"	XXXX PDWC 07000 X XXXX
7.250	6.999	7.228	D = W + 0.010"	XXXX PDWC 07250 X XXXX
7.500	7.249	7.478	D = W + 0.010"	XXXX PDWC 07500 X XXXX
7.750	7.499	7.728	D = W + 0.010"	XXXX PDWC 07750 X XXXX
8.000	7.749	7.977	D = W + 0.010"	XXXX PDWC 08000 X XXXX
8.250	7.999	8.227	D = W + 0.010"	XXXX PDWC 08250 X XXXX
8.500	8.249	8.477	D = W + 0.010"	XXXX PDWC 08500 X XXXX
9.000	8.749	8.977	D = W + 0.010"	XXXX PDWC 09000 X XXXX
9.500	9.249	9.477	D = W + 0.010"	XXXX PDWC 09500 X XXXX
10.000	9.749	9.977	D = W + 0.010"	XXXX PDWC 10000 X XXXX
10.500	10.249	10.477	D = W + 0.010"	XXXX PDWC 10500 X XXXX
11.000	10.749	10.977	D = W + 0.010"	XXXX PDWC 11000 X XXXX
11.500	11.249	11.477	D = W + 0.010"	XXXX PDWC 11500 X XXXX
12.000	11.749	11.977	D = W + 0.010"	XXXX PDWC 12000 X XXXX
12.500	12.249	12.477	D = W + 0.010"	XXXX PDWC 12500 X XXXX
13.000	12.749	12.977	D = W + 0.010"	XXXX PDWC 13000 X XXXX
13.500	13.249	13.477	D = W + 0.010"	XXXX PDWC 13500 X XXXX
14.000	13.749	13.977	D = W + 0.010"	XXXX PDWC 14000 X XXXX
14.500	14.249	14.477	D = W + 0.010"	XXXX PDWC 14500 X XXXX
15.000	14.749	14.977	D = W + 0.010"	XXXX PDWC 15000 X XXXX
15.500	15.249	15.477	D = W + 0.010"	XXXX PDWC 15500 X XXXX
16.000	15.749	15.977	D = W + 0.010"	XXXX PDWC 16000 X XXXX

For custom groove calculations, see Appendix C.

NOTE: For sizes larger than those shown in the table, please contact your local Parker Seal representative.

## PDW Piston Groove Calculation

See Piston Wear Ring Groove Calculation in Appendix C.



**PDW Profile**

**Gland Dimensions — PDW Profile, Rod**

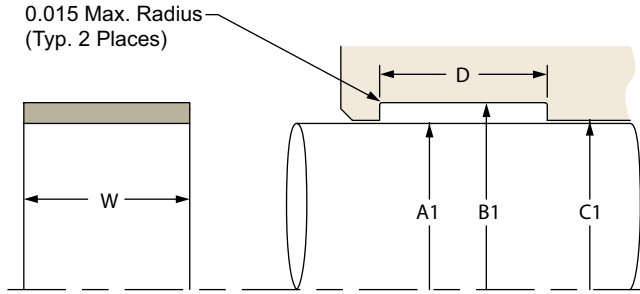

Please refer to Engineering Section 2, page 2-8 for surface finish and additional hardware considerations.

**Table 9-19. PDW Gland Dimensions (Rod) — Inch**

A1 Rod Diameter	B1 Groove Diameter	C1 Throat Diameter	D Groove Width	Part Number
<b>+ .000/- .002</b>	<b>+ .002/- .000</b>	<b>+ .002/- .000</b>	<b>+ .010/- .000</b>	<b>PDWD</b>
0.312	0.437	0.333	D = W + 0.010"	XXXX PDWD 00875 X XXXX
0.375	0.500	0.396	D = W + 0.010"	XXXX PDWD 00375 X XXXX
0.437	0.562	0.458	D = W + 0.010"	XXXX PDWD 00437 X XXXX
0.500	0.625	0.521	D = W + 0.010"	XXXX PDWD 00500 X XXXX
0.562	0.687	0.583	D = W + 0.010"	XXXX PDWD 00562 X XXXX
0.625	0.750	0.646	D = W + 0.010"	XXXX PDWD 00625 X XXXX
0.687	0.812	0.708	D = W + 0.010"	XXXX PDWD 00687 X XXXX
0.750	0.875	0.771	D = W + 0.010"	XXXX PDWD 00750 X XXXX
0.812	0.937	0.833	D = W + 0.010"	XXXX PDWD 00812 X XXXX
0.875	1.000	0.896	D = W + 0.010"	XXXX PDWD 00875 X XXXX
0.937	1.062	0.958	D = W + 0.010"	XXXX PDWD 00937 X XXXX
1.000	1.125	1.021	D = W + 0.010"	XXXX PDWD 01000 X XXXX
1.062	1.187	1.083	D = W + 0.010"	XXXX PDWD 01062 X XXXX
1.125	1.250	1.146	D = W + 0.010"	XXXX PDWD 01125 X XXXX
1.187	1.312	1.208	D = W + 0.010"	XXXX PDWD 01187 X XXXX
1.250	1.375	1.271	D = W + 0.010"	XXXX PDWD 01250 X XXXX
1.312	1.437	1.333	D = W + 0.010"	XXXX PDWD 01312 X XXXX
1.375	1.500	1.396	D = W + 0.010"	XXXX PDWD 01375 X XXXX
1.437	1.562	1.458	D = W + 0.010"	XXXX PDWD 01437 X XXXX
1.500	1.625	1.521	D = W + 0.010"	XXXX PDWD 01500 X XXXX
1.625	1.750	1.646	D = W + 0.010"	XXXX PDWD 01625 X XXXX
1.750	1.875	1.771	D = W + 0.010"	XXXX PDWD 01750 X XXXX
1.875	2.000	1.896	D = W + 0.010"	XXXX PDWD 01875 X XXXX
2.000	2.125	2.021	D = W + 0.010"	XXXX PDWD 02000 X XXXX
<b>+ .000/- .002</b>	<b>+ .002/- .000</b>	<b>+ .002/- .000</b>	<b>+ .010/- .000</b>	<b>PDWE</b>
1.500	1.687	1.521	D = W + 0.010"	XXXX PDWE 01500 X XXXX
1.625	1.812	1.646	D = W + 0.010"	XXXX PDWE 01625 X XXXX
1.750	1.937	1.771	D = W + 0.010"	XXXX PDWE 01750 X XXXX
1.875	2.062	1.896	D = W + 0.010"	XXXX PDWE 01875 X XXXX
2.000	2.187	2.021	D = W + 0.010"	XXXX PDWE 02000 X XXXX
2.125	2.312	2.146	D = W + 0.010"	XXXX PDWE 02125 X XXXX
2.250	2.437	2.271	D = W + 0.010"	XXXX PDWE 02250 X XXXX
2.375	2.562	2.396	D = W + 0.010"	XXXX PDWE 02375 X XXXX

For custom groove calculations, see Appendix C.

09/01/07



Table 9-19. PDW Gland Dimensions (Rod) — Inch (Continued)

A1 Rod Diameter	B1 Groove Diameter	C1 Throat Diameter	D Groove Width	Part Number
<b>+.000/-.002</b>	<b>+.002/-.000</b>	<b>+.002/-.000</b>	<b>+.010/-.000</b>	<b>PDWE</b>
2.500	2.687	2.521	D = W + 0.010"	XXXX PDWE 02500 X XXXX
2.625	2.812	2.646	D = W + 0.010"	XXXX PDWE 02625 X XXXX
2.750	2.937	2.771	D = W + 0.010"	XXXX PDWE 02750 X XXXX
2.875	3.062	2.896	D = W + 0.010"	XXXX PDWE 02875 X XXXX
3.000	3.187	3.021	D = W + 0.010"	XXXX PDWE 03000 X XXXX
3.125	3.312	3.146	D = W + 0.010"	XXXX PDWE 03125 X XXXX
3.250	3.437	3.271	D = W + 0.010"	XXXX PDWE 03250 X XXXX
3.375	3.562	3.396	D = W + 0.010"	XXXX PDWE 03375 X XXXX
3.500	3.687	3.521	D = W + 0.010"	XXXX PDWE 03500 X XXXX
3.625	3.812	3.646	D = W + 0.010"	XXXX PDWE 03625 X XXXX
3.750	3.937	3.771	D = W + 0.010"	XXXX PDWE 03750 X XXXX
3.875	4.062	3.896	D = W + 0.010"	XXXX PDWE 03875 X XXXX
4.000	4.187	4.021	D = W + 0.010"	XXXX PDWE 04000 X XXXX
4.125	4.312	4.146	D = W + 0.010"	XXXX PDWE 04125 X XXXX
4.250	4.437	4.271	D = W + 0.010"	XXXX PDWE 04250 X XXXX
4.375	4.562	4.396	D = W + 0.010"	XXXX PDWE 04375 X XXXX
4.500	4.687	4.521	D = W + 0.010"	XXXX PDWE 04500 X XXXX
4.625	4.812	4.646	D = W + 0.010"	XXXX PDWE 04625 X XXXX
4.750	4.937	4.771	D = W + 0.010"	XXXX PDWE 04750 X XXXX
4.875	5.062	4.896	D = W + 0.010"	XXXX PDWE 04875 X XXXX
5.000	5.187	5.021	D = W + 0.010"	XXXX PDWE 05000 X XXXX
<b>+.000/-.002</b>	<b>+.002/-.000</b>	<b>+.002/-.000</b>	<b>+.010/-.000</b>	<b>PDWF</b>
1.500	1.751	1.521	D = W + 0.010"	XXXX PDWF 01500 X XXXX
1.625	1.876	1.646	D = W + 0.010"	XXXX PDWF 01625 X XXXX
1.750	2.001	1.771	D = W + 0.010"	XXXX PDWF 01750 X XXXX
1.875	2.126	1.896	D = W + 0.010"	XXXX PDWF 01875 X XXXX
2.000	2.251	2.021	D = W + 0.010"	XXXX PDWF 02000 X XXXX
2.125	2.376	2.146	D = W + 0.010"	XXXX PDWF 02125 X XXXX
2.250	2.501	2.271	D = W + 0.010"	XXXX PDWF 02250 X XXXX
2.375	2.626	2.396	D = W + 0.010"	XXXX PDWF 02375 X XXXX
2.500	2.751	2.521	D = W + 0.010"	XXXX PDWF 02500 X XXXX
2.625	2.876	2.646	D = W + 0.010"	XXXX PDWF 02625 X XXXX
2.750	3.001	2.771	D = W + 0.010"	XXXX PDWF 02750 X XXXX
2.875	3.126	2.896	D = W + 0.010"	XXXX PDWF 02875 X XXXX
3.000	3.251	3.021	D = W + 0.010"	XXXX PDWF 03000 X XXXX
3.125	3.376	3.146	D = W + 0.010"	XXXX PDWF 03125 X XXXX
3.250	3.501	3.271	D = W + 0.010"	XXXX PDWF 03250 X XXXX
3.375	3.626	3.396	D = W + 0.010"	XXXX PDWF 03375 X XXXX
3.500	3.751	3.521	D = W + 0.010"	XXXX PDWF 03500 X XXXX
3.625	3.876	3.646	D = W + 0.010"	XXXX PDWF 03625 X XXXX
3.750	4.001	3.771	D = W + 0.010"	XXXX PDWF 03750 X XXXX
3.875	4.126	3.896	D = W + 0.010"	XXXX PDWF 03875 X XXXX
4.000	4.251	4.021	D = W + 0.010"	XXXX PDWF 04000 X XXXX

For custom groove calculations, see Appendix C.

09/01/07

9

**PDW Profile****Table 9-19. PDW Gland Dimensions (Rod) — Inch (Continued)**

A1 Rod Diameter	B1 Groove Diameter	C1 Throat Diameter	D Groove Width	Part Number
4.125	4.376	4.146	D = W + 0.010"	XXXX PDWF 04125 X XXXX
4.250	4.501	4.271	D = W + 0.010"	XXXX PDWF 04250 X XXXX
4.375	4.626	4.396	D = W + 0.010"	XXXX PDWF 04375 X XXXX
4.500	4.751	4.521	D = W + 0.010"	XXXX PDWF 04500 X XXXX
4.625	4.876	4.646	D = W + 0.010"	XXXX PDWF 04625 X XXXX
<b>+ .000/- .004</b>	<b>+ .003/- .000</b>	<b>+ .003/- .000</b>	<b>+ .010/- .000</b>	<b>PDWF</b>
4.750	5.001	4.772	D = W + 0.010"	XXXX PDWF 04750 X XXXX
4.875	5.126	4.897	D = W + 0.010"	XXXX PDWF 04875 X XXXX
5.000	5.251	5.022	D = W + 0.010"	XXXX PDWF 05000 X XXXX
5.125	5.376	5.147	D = W + 0.010"	XXXX PDWF 05125 X XXXX
5.250	5.501	5.272	D = W + 0.010"	XXXX PDWF 05250 X XXXX
5.375	5.626	5.397	D = W + 0.010"	XXXX PDWF 05375 X XXXX
5.500	5.751	5.522	D = W + 0.010"	XXXX PDWF 05500 X XXXX
5.625	5.876	5.647	D = W + 0.010"	XXXX PDWF 05625 X XXXX
5.750	6.001	5.772	D = W + 0.010"	XXXX PDWF 05750 X XXXX
5.875	6.126	5.897	D = W + 0.010"	XXXX PDWF 05875 X XXXX
6.000	6.251	6.022	D = W + 0.010"	XXXX PDWF 06000 X XXXX
6.250	6.501	6.272	D = W + 0.010"	XXXX PDWF 06250 X XXXX
6.500	6.751	6.522	D = W + 0.010"	XXXX PDWF 06500 X XXXX
6.750	7.001	6.772	D = W + 0.010"	XXXX PDWF 06750 X XXXX
7.000	7.251	7.022	D = W + 0.010"	XXXX PDWF 07000 X XXXX
7.250	7.501	7.272	D = W + 0.010"	XXXX PDWF 07250 X XXXX
7.500	7.751	7.522	D = W + 0.010"	XXXX PDWF 07500 X XXXX

For custom groove calculations, see Appendix C.

NOTE: For sizes larger than those shown in the table, please contact your local Parker Seal representative.

**PDW Rod Groove Calculation**

See Rod Wear Ring Groove Calculations in Appendix C.

## Contents

Product Offering ..... 10-3  
 Decision Tree ..... 10-3  
 Product Profiles  
   MB ..... 10-4  
   8700 ..... 10-10  
   5100 ..... 10-13  
   Positively-Activated..... 10-21  
   PDB ..... 10-22

## Back-up Rings

Back-up rings are the most common anti-extrusion devices in dynamic sealing. They provide simple solutions to safely increase system pressure or solve an existing seal extrusion problem. Back-up rings function by positioning a more robust material adjacent to the extrusion gap, taking the seal's place and providing a barrier against high pressures. Back-ups can be used to offset the reduced pressure rating effects of wear rings or to improve seal life at increased pressures. They can also be used to protect seals against pressure spikes, or to ensure seal performance at higher temperatures.

Parker offers a wide range of back-up ring profiles and materials to complement each seal type and to suit every application. Modular back-up rings disperse pressure from the seal throughout the gland to fill the extrusion gap and protect the seal (see Figure 10-1). The use of Profile MB can increase a PolyPak's pressure rating to 10,000 psi, while 8700 back-ups provide added extrusion resistance to u-cups with only a minimal increase in gland width.

Positively-actuated back-ups are actuated both axially and radially into the extrusion gap, guarding the seal against extrusion (see Figure 10-2). For many profiles, positively-actuated back-ups can provide the ultimate extrusion resistance while retaining the seal's original gland dimensions.

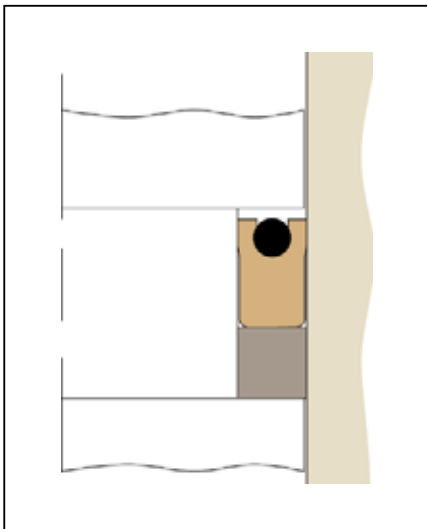

Figure 10-1. Modular Back-up Ring

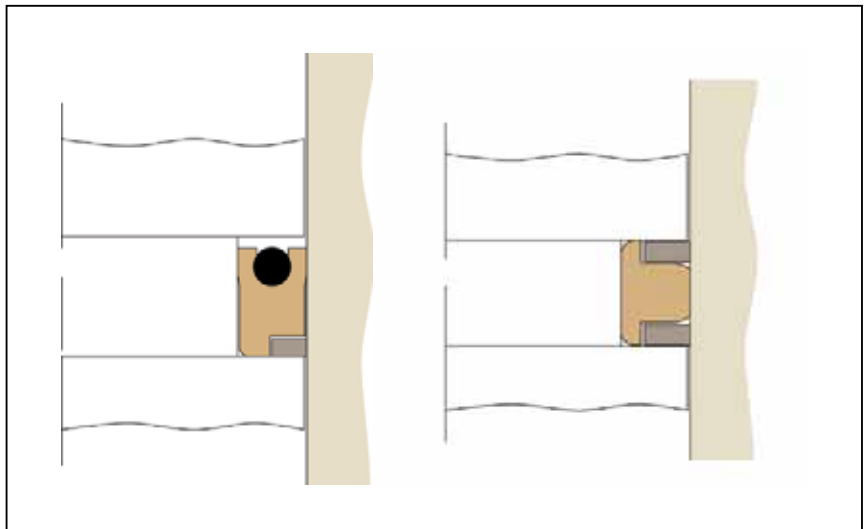
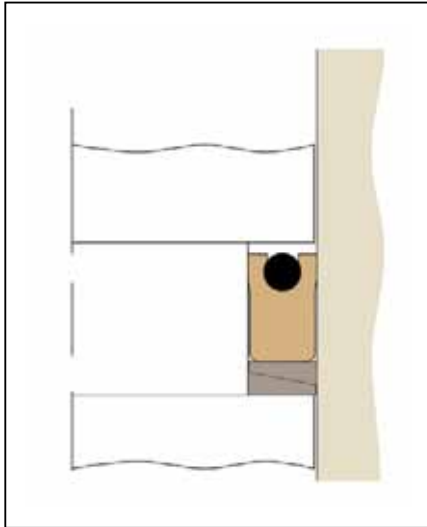

Figure 10-2. Positively-Actuated Back-up

**Back-up Rings Introduction (Continued)**

For extreme pressures, Parker can design custom back-up ring systems utilizing metal or engineered plastics technology and highly advanced geometries. In Figure 10-3 (angled back-ups), a single modular back-up is replaced with dual wedge-shaped back-ups, composed of UltraCOMP or bronze. As pressure increases, the angled back-ups are forced to bridge the clearance gap, eliminating extrusion. This method has been used successfully at pressures as high as 100,000 psi. Please contact Parker or your authorized distributor for engineering assistance in designing custom back-up configurations.



*Figure 10-3. Angled Back-up*

**When to Use Back-up Rings**







- System operating pressure exceeds the limitations of the seal's extrusion resistance.
- Pressure spikes in the system exceed normal operating conditions, risking damage to the seal.
- The use of wear rings has increased the extrusion gap, reducing the seal's pressure rating to an unacceptable level.
- The system temperature is high enough to lower the seal's extrusion resistance to an unacceptable level.

# Back-up Rings Product Offering





Catalog EPS 5370/USA

## Profiles

Table 10-1: Product Profiles

Series	Description	Application (Duty)				Page
		Light	Medium	Heavy	Pneumatic	
MB	Modular Back-up for PolyPaks & U-cups					10-4
8700	Low Profile Back-up for PolyPaks & U-cups					10-10
5100	O-ring Groove Back-up					10-13

Series	Description	Application (Duty)				Page
		Light	Medium	Heavy	Pneumatic	
PAB	Positively-Activated Back-up					10-21
PDB	PTFE Back-up					10-22

# Back-up Rings Decision Tree

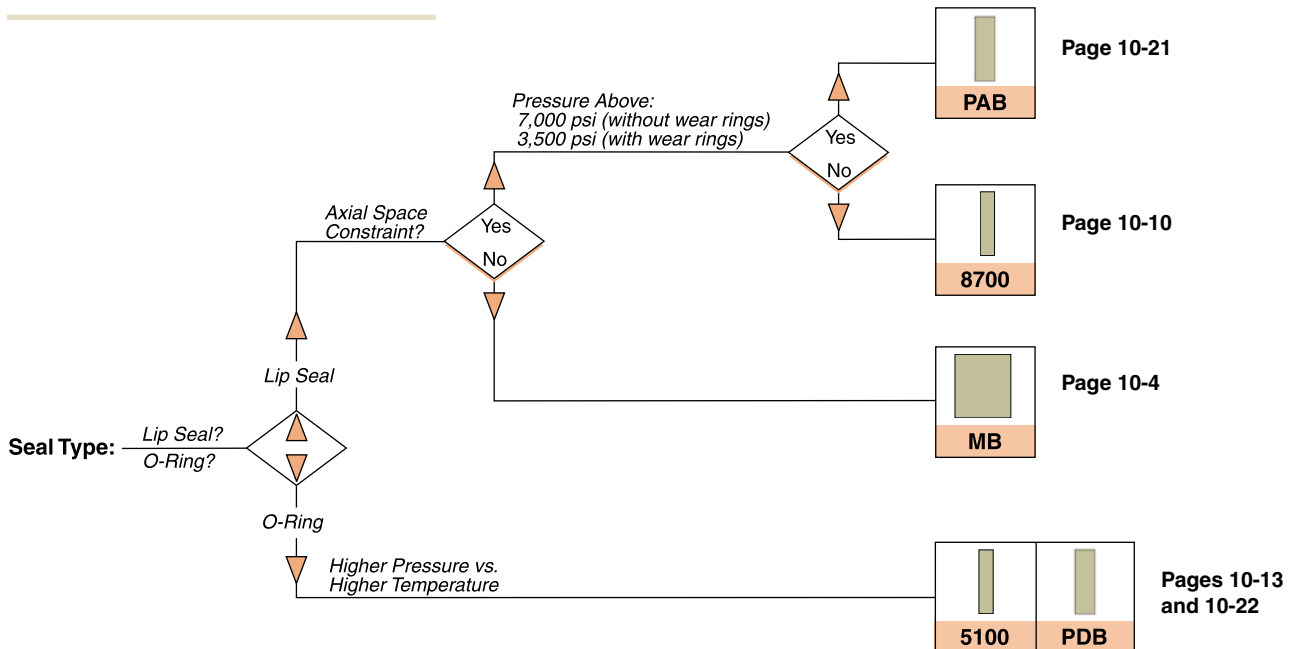

09/01/07



# Back-up Ring MB Profile

Catalog EPS 5370/USA



## MB Profile, Modular Back-up for PolyPaks and U-cups

Modular back-ups, MB profile, are specifically designed to compliment the PolyPak profiles. To help make the selection and ordering of the correct part number for the MB profile easy and efficient, the part numbering system used is very similar to that of the PolyPak. By formulating high modulus blends of Molythane (4617) and PolyMyte (4652), Parker has ensured that MB back-ups can be used with either type of base sealing material while maintaining the expected temperature range and fluid compatibility. The robust design ensures pressure ratings up to 10,000 psi are met.

### Technical Data

Standard Materials*	Temperature	Max. Pressure Range**
P4617D65	-65°F to 250°F (-54°C to 121°C)	10,000 psi (689 bar)
Z4652D65	-65°F to 275°F (-54°C to 135°C)	10,000 psi (689 bar)

\***Alternate Materials:** For applications that may require an alternate material, please contact your local Parker Seal representative.

\*\* 7,000 psi (482 bar) with tight-tolerance wear rings.  
5,000 psi (344 bar) with standard-tolerance wear rings.

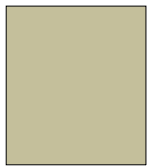

*MB Cross-Section*

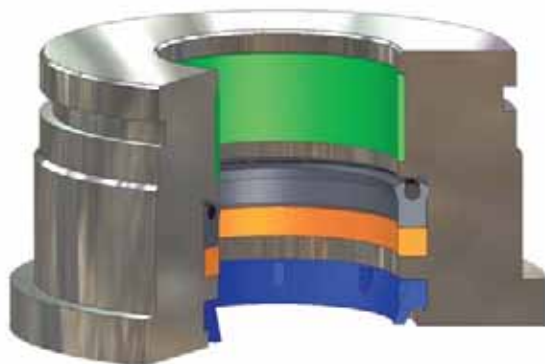

*MB installed in Rod Gland*

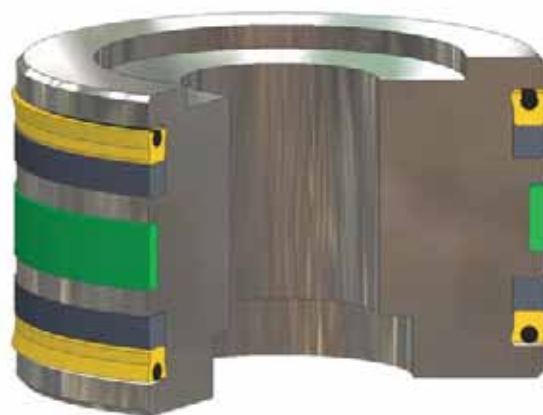

*MB installed in Piston Gland*

10

09/01/07



**Part Number Nomenclature — MB Profile**

**Table 10-2. MB Profile — Inch**

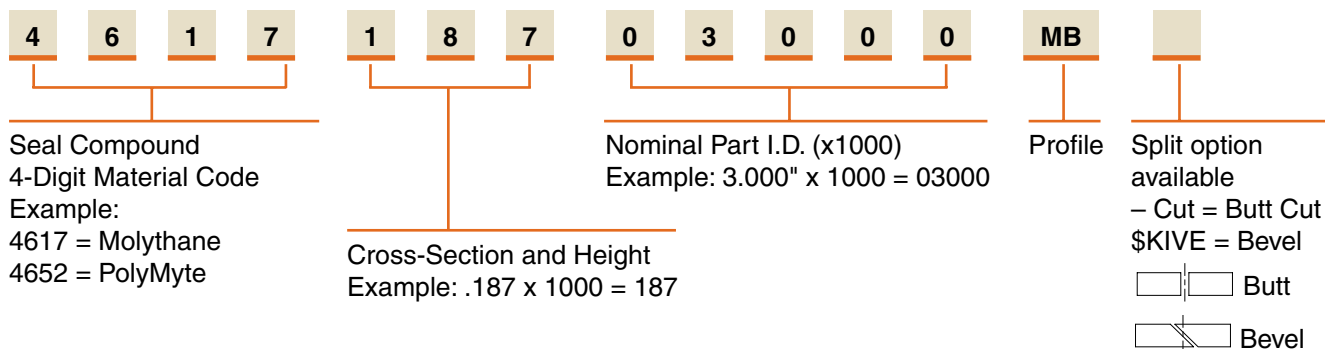

**Gland Dimensions — MB Profile**

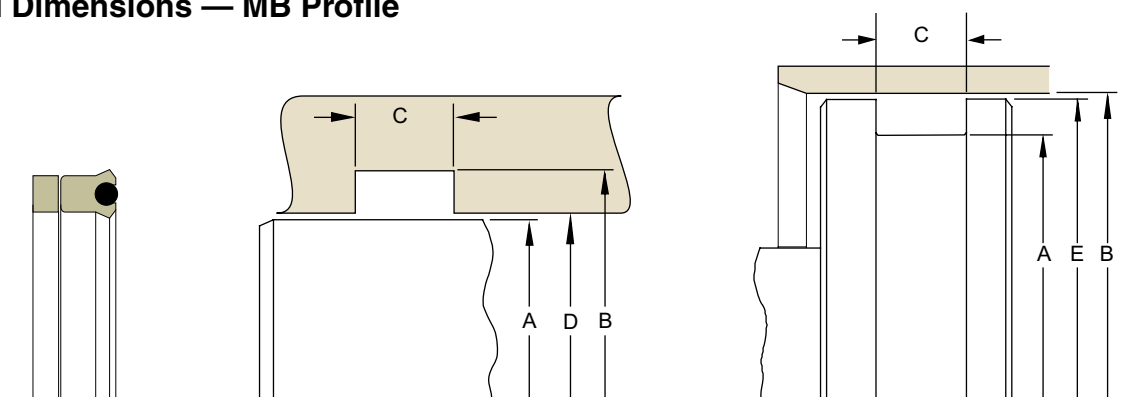

Please refer to Engineering Section 2, page 2-8 for surface finish and additional hardware considerations.

**How to Determine the Gland Width when Using Modular Back-up Rings**

The Modular Back-up ring allows you to extend the pressure rating of a seal that fits into the common gland used by such seals as the PolyPaks and the BS, BT, BD, B3, B7, UP, UR and US Profiles. In order to use the MB Back-up ring the width of the seal gland must be extended to account for the height of the Modular Back-up ring. Add the following width to the gland of the seal only as shown in this catalog.

**Table 10-3. Added Gland Width Values**

Seal Cross Section	Added Gland Width
1/8	0.138
3/16	0.206
1/4	0.275
5/16	0.343
3/8	0.413
7/16	0.481
1/2	0.550
5/8	0.688
3/4	0.825
1	1.100

**For non-standard cross sections** the added gland width can be determined by multiplying the cross section by (1.1). The tolerance on the extended gland remains the same as it is for the seal gland width, which is usually +.015.

**Table 10-4. MB Gland Dimensions — Inch (All dimensions are reference)**

A	B	C	D	E	Material		Part Number
Rod Diameter	(Rod) Groove Diameter	(Rod) Groove Width	Throat Diameter*		4617	4652	
(Piston) Groove Diameter	Bore Diameter	Groove Width		Piston Diameter**			
0.125	0.375	Add to gland width the corresponding value from Table 10-3.	0.126	0.374	X	X	xxxx12500125MB
0.250	0.500		0.251	0.499	X	X	xxxx12500250MB
0.312	0.562		0.313	0.561	X		xxxx12500312MB
0.375	0.625		0.376	0.624	X	X	xxxx12500375MB
0.500	0.750		0.501	0.749	X	X	xxxx12500500MB
0.500	0.875		0.501	0.874	X		xxxx18700500MB
0.500	1.000		0.501	0.999	X	X	xxxx25000500MB
0.625	0.875		0.626	0.874	X	X	xxxx12500625MB
0.625	1.000		0.626	0.999	X	X	xxxx18700625MB
0.625	1.125		0.626	1.124	X		xxxx25000625MB
0.625	1.375		0.627	1.373		X	xxxx37501000MB
0.687	0.937		0.688	0.936	X		xxxx12500687MB
0.750	1.000		0.751	0.999	X	X	xxxx12500750MB
0.750	1.250		0.751	1.249	X	X	xxxx25000750MB
0.875	1.375		0.876	1.374	X		xxxx25000875MB
0.937	1.187		0.938	1.186	X		xxxx12500937MB
1.000	1.250		1.001	1.249	X	X	xxxx12501000MB
1.000	1.375		1.001	1.374	X		xxxx18701000MB
1.000	1.500		1.001	1.499	X	X	xxxx25001000MB
1.125	1.500		1.126	1.499			xxxx18701125MB
1.250	1.500		1.251	1.499	X	X	xxxx12501250MB
1.250	1.625		1.251	1.624	X	X	xxxx18701250MB
1.250	1.750		1.251	1.749	X	X	xxxx25001250MB
1.250	1.875		1.252	1.873	X	X	xxxx31201250MB
1.250	2.000		1.252	1.998	X		xxxx37501250MB
1.312	1.812		1.313	1.811	X		xxxx25001312MB
1.375	1.625		1.376	1.624	X		xxxx12501375MB
1.375	1.750		1.376	1.749	X	X	xxxx18701375MB
1.375	1.875		1.376	1.874	X	X	xxxx25001375MB
1.375	2.000		1.377	1.998	X		xxxx31201375MB
1.500	1.750		1.501	1.749	X		xxxx12501500MB
1.500	1.875		1.501	1.874	X	X	xxxx18701500MB
1.500	2.000		1.501	1.999	X		xxxx25001500MB
1.500	2.125		1.502	2.123	X		xxxx31201500MB
1.500	2.250		1.502	2.248	X	X	xxxx37501500MB
1.625	2.000		1.626	1.999	X	X	xxxx18701625MB
1.625	2.250		1.627	2.248	X		xxxx31201625MB
1.625	2.375		1.627	2.373	X	X	xxxx37501625MB
1.750	2.250		1.751	2.249	X	X	xxxx25001750MB
1.750	2.375		1.752	2.373	X	X	xxxx31201750MB
1.750	2.500	1.752	2.498	X		xxxx37501750MB	
1.875	2.250	1.876	2.249	X	X	xxxx18701875MB	
1.875	2.500	1.877	2.498	X		xxxx31201875MB	
1.875	2.625	1.877	2.623	X	X	xxxx37501875MB	
2.000	2.500	2.001	2.499	X	X	xxxx25002000MB	
2.000	2.625	2.002	2.623	X		xxxx31202000MB	

\* If used with wear rings, refer to wear ring throat diameter, see Section 9.  
 \*\* If used with wear rings, refer to wear ring piston diameter, see Section 9.



Table 10-4. MB Gland Dimensions — Inch (Continued) (All dimensions are reference)

A Rod Diameter	B (Rod) Groove Diameter	C (Rod) Groove Width	D Throat Diameter*	E Piston Diameter**	Material		Part Number
					4617	4652	
(Piston) Groove Diameter	Bore Diameter	Groove Width					
2.000	2.750	Add to gland width the corresponding value from Table 10-3.	2.002	2.748	X	X	xxxx37502000MB
2.000	3.000		2.002	2.998	X		xxxx50002000MB
2.125	2.500		2.126	2.499	X	X	xxxx18702125MB
2.250	2.750		2.251	2.749	X	X	xxxx25002250MB
2.250	2.875		2.252	2.873	X		xxxx31202250MB
2.250	3.000		2.252	2.998	X		xxxx37502250MB
2.250	3.250		2.252	3.248	X		xxxx50002250MB
2.375	3.000		2.377	2.998	X		xxxx31202375MB
2.375	3.125		2.377	3.123	X		xxxx37502375MB
2.500	2.875		2.501	2.874	X		xxxx18702500MB
2.500	3.000		2.501	2.999	X	X	xxxx25002500MB
2.500	3.125		2.502	3.123	X		xxxx31202500MB
2.500	3.250		2.502	3.248	X		xxxx37502500MB
2.500	3.500		2.502	3.498	X		xxxx50002500MB
2.500	3.750		2.503	3.747	X		xxxx62502500MB
2.625	3.000		2.626	2.999	X		xxxx18702625MB
2.625	3.125		2.626	3.124	X		xxxx25002625MB
2.625	3.375		2.627	3.373	X		xxxx37502625MB
2.750	3.125		2.751	3.124	X		xxxx18702750MB
2.750	3.250		2.751	3.249	X	X	xxxx25002750MB
2.750	3.500		2.752	3.498	X	X	xxxx37502750MB
2.750	4.000		2.753	3.997	X		xxxx62502750MB
2.875	3.375		2.876	3.374	X		xxxx25002875MB
3.000	3.375		3.001	3.374	X	X	xxxx18703000MB
3.000	3.500		3.001	3.499	X	X	xxxx25003000MB
3.000	3.625		3.002	3.623	X		xxxx31203000MB
3.000	3.750		3.002	3.748	X	X	xxxx37503000MB
3.000	4.000		3.002	3.998	X		xxxx50003000MB
3.000	4.250		3.003	4.247	X		xxxx62503000MB
3.125	3.500		3.126	3.499	X	X	xxxx18703125MB
3.125	3.625		3.126	3.624		X	xxxx25003125MB
3.125	3.875		3.127	3.873	X		xxxx37503125MB
3.250	3.625		3.251	3.624	X		xxxx18703250MB
3.250	3.750		3.251	3.749	X	X	xxxx25003250MB
3.250	4.000		3.252	3.998	X		xxxx37503250MB
3.250	4.500		3.253	4.497	X		xxxx62503250MB
3.375	4.125		3.377	4.123	X		xxxx37503375MB
3.500	3.875		3.501	3.874	X	X	xxxx18703500MB
3.500	4.000		3.501	3.999	X	X	xxxx25003500MB
3.500	4.125		3.502	4.123	X	X	xxxx31203500MB
3.500	4.250	3.502	4.248	X	X	xxxx37503500MB	
3.500	4.500	3.502	4.498	X		xxxx50003500MB	
3.625	4.000	3.626	3.999	X	X	xxxx18703625MB	
3.750	4.250	3.751	4.249	X	X	xxxx25003750MB	
3.750	4.375	3.752	4.373	X		xxxx31203750MB	
3.750	4.500	3.752	4.498	X	X	xxxx37503750MB	

\* If used with wear rings, refer to wear ring throat diameter, see Section 9.

\*\* If used with wear rings, refer to wear ring piston diameter, see Section 9.

**Table 10-4. MB Gland Dimensions — Inch (Continued) (All dimensions are reference)**

A	B	C	D	E	Material		Part Number
Rod Diameter	(Rod) Groove Diameter	(Rod) Groove Width	Throat Diameter*		4617	4652	
(Piston) Groove Diameter	Bore Diameter	Groove Width		Piston Diameter**			
4.000	4.375	Add to gland width the corresponding value from Table 10-3.	4.001	4.374		X	xxxx18704000MB
4.000	4.500		4.001	4.499	X	X	xxxx25004000MB
4.000	4.750		4.002	4.748	X		xxxx37504000MB
4.000	5.000		4.002	4.998	X		xxxx50004000MB
4.250	4.750		4.251	4.749	X		xxxx25004250MB
4.250	5.000		4.252	4.998	X	X	xxxx37504250MB
4.375	4.750		4.376	4.749	X		xxxx18704375MB
4.375	5.000		4.377	4.998	X		xxxx31204375MB
4.375	5.125		4.377	5.123	X		xxxx37504375MB
4.500	5.000		4.501	4.999	X	X	xxxx25004500MB
4.500	5.125		4.502	5.123	X	X	xxxx31204500MB
4.500	5.500		4.502	5.498	X		xxxx50004500MB
4.750	5.500		4.752	5.498	X	X	xxxx37504750MB
4.875	5.625		4.877	5.623	X		xxxx37504875MB
5.000	5.500		5.001	5.499	X	X	xxxx25005000MB
5.000	5.750		5.002	5.748	X	X	xxxx37505000MB
5.000	6.000		5.002	5.998	X	X	xxxx50005000MB
5.250	5.750		5.251	5.749	X		xxxx25005250MB
5.250	6.000		5.252	5.998	X	X	xxxx37505250MB
5.250	6.250		5.252	6.248	X	X	xxxx50005250MB
5.375	6.000		5.377	5.998	X		xxxx31205375MB
5.375	6.125		5.377	6.123	X		xxxx37505375MB
5.500	6.000		5.501	5.999	X	X	xxxx25005500MB
5.500	6.250		5.502	6.248	X	X	xxxx37505500MB
5.500	6.500		5.502	6.498	X	X	xxxx50005500MB
5.750	6.250		5.751	6.249		X	xxxx25005750MB
5.875	6.625		5.877	6.623	X	X	xxxx37505875MB
6.000	6.500		6.001	6.499	X	X	xxxx25006000MB
6.000	6.750		6.002	6.748	X	X	xxxx37506000MB
6.000	7.000		6.002	6.998	X		xxxx50006000MB
6.250	7.000		6.252	6.998	X	X	xxxx37506250MB
6.500	7.250		6.502	7.248	X	X	xxxx37506500MB
6.500	7.500		6.502	7.498	X	X	xxxx50006500MB
6.500	8.000		6.503	7.997	X		xxxx75006500MB
6.750	7.750		6.752	7.748	X		xxxx50006750MB
7.000	7.750		7.002	7.748	X	X	xxxx37507000MB
7.000	8.000		7.002	7.998	X	X	xxxx50007000MB
7.000	8.250		7.003	8.247	X		xxxx62507000MB
7.250	8.000		7.252	7.998	X	X	xxxx37507250MB
7.500	8.000		7.501	7.999	X	X	xxxx25007500MB
7.500	8.250	7.502	8.248	X		xxxx37507500MB	
7.500	9.000	7.503	8.997	X		xxxx75007500MB	
7.750	8.250	7.751	8.249	X		xxxx25007750MB	
7.750	8.500	7.752	8.498	X		xxxx37507750MB	
8.000	8.625	8.002	8.623	X		xxxx31208000MB	
8.000	9.000	8.002	8.998	X		xxxx50008000MB	

\* If used with wear rings, refer to wear ring throat diameter, see Section 9.  
 \*\* If used with wear rings, refer to wear ring piston diameter, see Section 9.



Table 10-4. MB Gland Dimensions — Inch (Continued) (All dimensions are reference)

A	B	C	D	E	Material		Part Number
Rod Diameter	(Rod) Groove Diameter	(Rod) Groove Width	Throat Diameter*		4617	4652	
(Piston) Groove Diameter	Bore Diameter	Groove Width		Piston Diameter**			
8.500	9.500	Add to gland width the corresponding value from Table 10-3.	8.502	9.498	X	X	xxxx50008500MB
9.000	9.750		9.002	9.748	X	X	xxxx37509000MB
9.000	10.000		9.002	9.998	X	X	xxxx50009000MB
9.250	10.000		9.252	9.998	X	X	xxxx37509250MB
9.500	10.500		9.502	10.498	X		xxxx50009500MB
9.750	10.500		9.752	10.498	X		xxxx37509750MB
9.875	10.875		9.877	10.873	X		xxxx50009875MB
10.000	10.500		10.001	10.499	X		xxxx25010000MB
10.000	10.750		10.002	10.748	X		xxxx37510000MB
10.000	11.000		10.002	10.998	X		xxxx50010000MB
10.500	11.250		10.502	11.248	X		xxxx37510500MB
10.500	11.500		10.502	11.498	X	X	xxxx50010500MB
11.000	11.750		11.002	11.748	X		xxxx37511000MB
11.000	12.000		11.002	11.998		X	xxxx50011000MB
11.250	12.000		11.252	11.998	X		xxxx37511250MB
11.500	12.500		11.502	12.498	X	X	xxxx50011500MB
12.000	13.000		12.002	12.998	X	X	xxxx50012000MB
12.750	14.000		12.753	13.997	X		xxxx62512750MB
13.000	13.500		13.001	13.499	X	X	xxxx25011750MB
13.500	14.500		13.502	14.498	X	X	xxxx50013500MB
14.000	14.500		14.001	14.499		X	xxxx25012000MB
15.000	16.000		15.002	15.998	X	X	xxxx50015000MB
17.000	18.000		17.002	17.998	X		xxxx50017000MB
17.750	19.000		17.753	18.997		X	xxxx62517750MB
19.000	20.000		19.002	19.998	X		xxxx50019000MB
21.000	22.000		21.002	21.998	X	X	xxxx50021000MB
29.000	30.000		29.002	29.998	X		xxxx50029000MB

\* If used with wear rings, refer to wear ring throat diameter, see Section 9.

\*\* If used with wear rings, refer to wear ring piston diameter, see Section 9.

NOTE: For sizes larger than those shown in the table, please contact your local Parker Seal representative.

# Back-up Ring 8700 Profile

Catalog EPS 5370/USA



## 8700 Profile, Low Profile Modular Back-up for PolyPaks and U-cups

8700 back-ups provide added extrusion resistance to u-cups and PolyPaks with only minimal increase in gland width. This profile of back-ups was originally designed to dramatically increase the pressure rating of rubber u-cups in situations where temperature or fluid compatibility prevent the use of urethane seals. As such, 8700 back-ups share a part numbering system very similar to many of our rubber u-cup profiles for easy matching of components. Additionally, they are perfect for adding heavy duty pressure capabilities to medium duty urethane sealing systems.

### Technical Data

Standard Materials*	Temperature	Max. Pressure Range**
Z4651D60	-65°F to 275°F (-54°C to 135°C)	7,000 psi (482 bar)
Z4729D65	-65°F to 275°F (-54°C to 135°C)	7,000 psi (482 bar)

**\*Alternate Materials:** For applications that may require an alternate material, please contact your local Parker Seal representative.

\*\* 4,900 psi (337 bar) with tight-tolerance wear rings.  
3,500 psi (241 bar) with standard-tolerance wear rings.



8700 Cross-Section

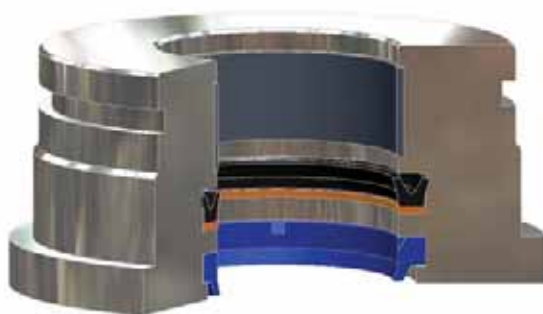

8700 installed in Rod Gland

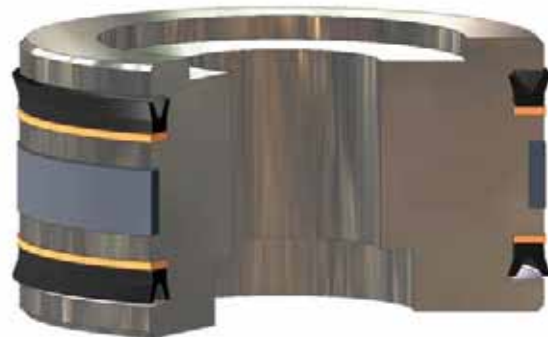

8700 installed in Piston Gland

**Part Number Nomenclature — 8700 Profile**

Table 10-5. 8700 Profile — Inch

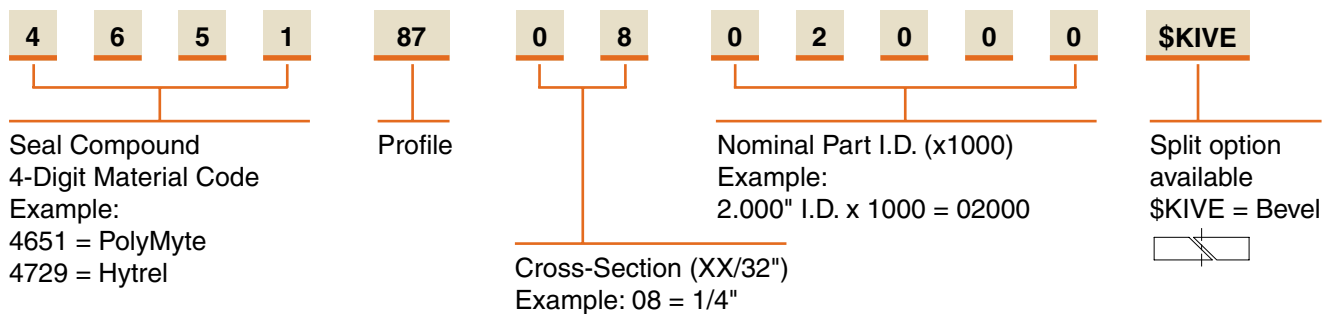

**Gland Dimensions — 8700 Profile**

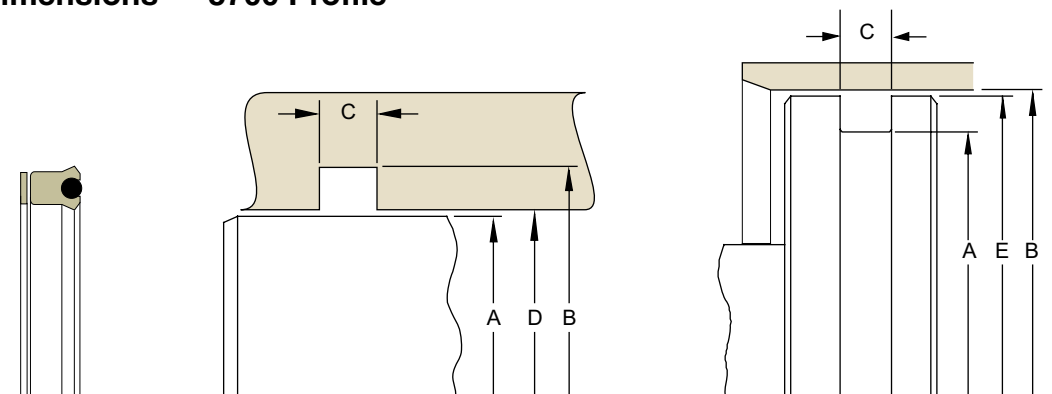

Please refer to Engineering Section 2, page 2-8 for surface finish and additional hardware considerations.

Table 10-6. 8700 Gland Dimensions (Standard) — Inch<sup>6</sup>

A	B	C	D	E	Part Number			
Rod Diameter	(Rod) Groove Diameter	(Rod) Groove Width	(Rod) Throat Diameter*			Compound Code	Profile Code	
(Bore) Groove Diameter	Bore Diameter	(Bore) Groove Width		(Bore) Piston Diameter**	Radial Cross Section			
0.375	0.625	Add .062" to seal groove width	0.376	0.624	0.1250	XXXX	87	0400375
0.500	0.750		0.501	0.749	0.1250	XXXX	87	0400500
0.625	0.875		0.626	0.874	0.1250	XXXX	87	0400625
0.750	1.000		0.751	0.999	0.1250	XXXX	87	0400750
1.000	1.250		1.001	1.249	0.1250	XXXX	87	0401000
1.000	1.312		1.001	1.311	0.1560	XXXX	87	0501000
1.187	1.500		1.188	1.499	0.1565	XXXX	87	0501187
1.250	1.625		1.251	1.624	0.1875	XXXX	87	0601250
1.250	1.750		1.251	1.749	0.2500	XXXX	87	0801250
1.375	1.687		1.376	1.686	0.1560	XXXX	87	0501375
1.375	1.750		1.377	1.749	0.1875	XXXX	87	0601375
1.500	1.812		1.501	1.811	0.1560	XXXX	87	0501500
1.500	1.875		1.502	1.874	0.1875	XXXX	87	0601500
1.500	2.250		1.501	2.249	0.2500	XXXX	87	0801500
1.625	2.000		1.627	1.999	0.1875	XXXX	87	0601625
1.750	2.125		1.752	2.124	0.1875	XXXX	87	0601750

\*If used with wear rings, refer to wear ring throat diameter, see Section 9.  
\*\*If used with wear rings, refer to wear ring piston diameter, see Section 9.



**8700 Profile**

**Table 10-6. 8700 Gland Dimensions — Inch (Continued)**

A	B	C	D	E	Part Number			
Rod Diameter	(Rod) Groove Diameter	(Rod) Groove Width	(Rod) Throat Diameter*					
(Bore) Groove Diameter	Bore Diameter	(Bore) Groove Width		(Bore) Piston Diameter**	Radial Cross Section	Compound Code	Profile Code	
2.000	2.375	Add .062" to seal groove width	2.002	2.374	0.1875	XXXX	87	0602000
2.000	2.500		2.001	2.499	0.2500	XXXX	87	0802000
2.125	2.500		2.127	2.499	0.1875	XXXX	87	0602125
2.500	2.937		2.501	2.936	0.2185	XXXX	87	0702500
2.812	3.250		2.813	3.249	0.2190	XXXX	87	0702812
3.000	3.437		3.001	3.436	0.2185	XXXX	87	0703000
3.062	3.500		3.063	3.499	0.2190	XXXX	87	0703062
3.250	3.750		3.251	3.749	0.2500	XXXX	87	0803250
3.500	4.000		3.501	3.999	0.2500	XXXX	87	0803500
3.750	4.250		3.751	4.249	0.2500	XXXX	87	0803750
4.000	4.500		4.001	4.499	0.2500	XXXX	87	0804000
4.500	5.000		4.501	4.999	0.2500	XXXX	87	0804500
5.000	5.562		5.001	5.561	0.2810	XXXX	87	0905000
5.375	6.000		5.377	5.998	0.3125	XXXX	87	1005375
5.375	6.125		5.377	6.123	0.3750	XXXX	87	1205375
5.437	6.000		5.438	5.999	0.2815	XXXX	87	0905437
5.500	6.125		5.502	6.123	0.3125	XXXX	87	1005500
6.375	7.000		6.377	6.998	0.3125	XXXX	87	1006375
6.437	7.000		6.438	6.999	0.2815	XXXX	87	0906437
7.000	7.625		7.002	7.623	0.3125	XXXX	87	1007000
7.375	8.000		7.377	7.998	0.3125	XXXX	87	1007375
8.500	9.125		8.502	9.123	0.3125	XXXX	87	1008500
10.000	10.750		10.002	10.748	0.3750	XXXX	87	1210000
11.000	12.000		11.002	11.998	0.5000	XXXX	87	1611000
11.250	12.000	11.252	11.998	0.3750	XXXX	87	1211250	

\*If used with wear rings, refer to wear ring throat diameter, see Section 9.

\*\*If used with wear rings, refer to wear ring piston diameter, see Section 9.

NOTE: For sizes larger than those shown in the table, please contact your local Parker Seal representative.

# Back-up Ring 5100 Profile

Catalog EPS 5370/USA



## 5100 Profile (5100 Series), O-ring Groove Back-up

Parker's 5100 Series back-up rings offer extrusion resistance up to 7,000 psi for dynamic applications and up to 20,000 psi for static applications. They are physically interchangeable with most existing o-ring back-ups. Our easy to identify orange colored 4651 PolyMyte material used with this profile, provides outstanding extrusion resistance when compared to hard nitrile back-ups plus offers extended fluid compatibility. 5100 Series back-ups are designed to meet standard industrial o-ring groove dimensions for single or dual back-up groove designs and will always install in the proper direction.

**Note:** For custom tolerances for rod or piston application, please contact your Parker Seal representative.

## Technical Data

Standard Materials*	Temperature	Max. Pressure Range	
		Dynamic**	Static
Z4651D60	-65°F to 275°F (-54°C to 135°C)	7,000 psi (482 bar)	20,000 psi (1,379 bar)
Z4729D65	-65°F to 275°F (-54°C to 135°C)	7,000 psi (482 bar)	20,000 psi (1,379 bar)

\***Alternate Materials:** For applications that may require an alternate material, please contact your local Parker Seal representative.

\*\* 4,900 psi (337 bar) with tight-tolerance wear rings.  
3,500 psi (241 bar) with standard-tolerance wear rings.



5100 Cross-Section

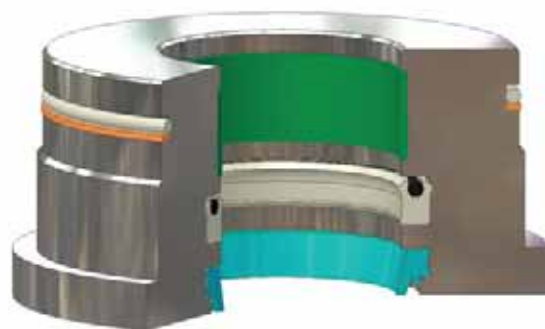

5100 installed in Rod Gland

10

09/01/07

## 5100 Profile

### Part Number Nomenclature — 5100 Profile

Table 10-7. 5100 Profile — Inch

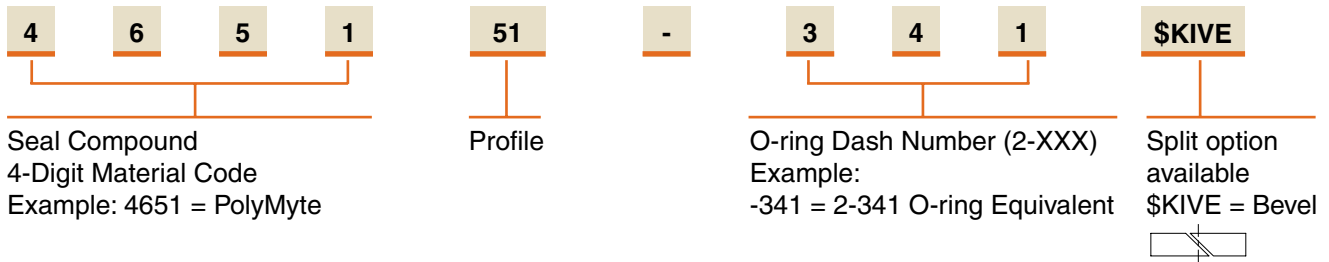

### Gland Dimensions — 5100 Profile

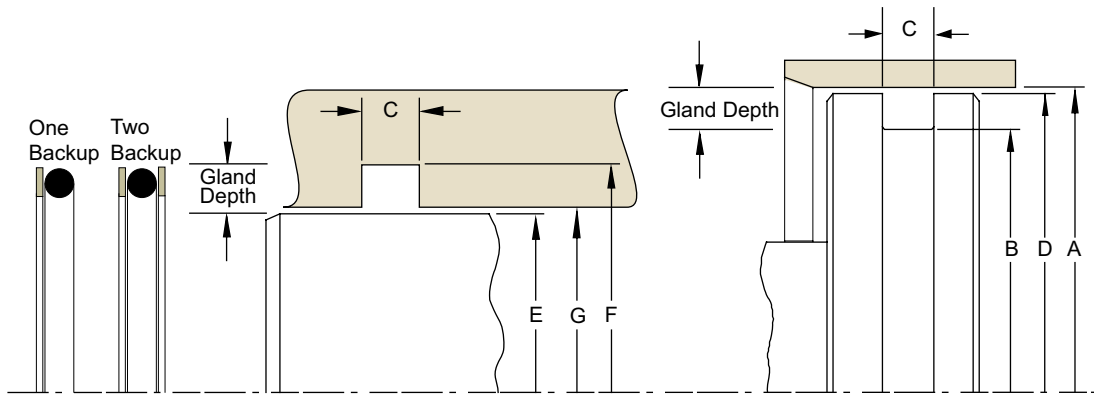

Please refer to Engineering Section 2, page 2-8 for surface finish and additional hardware considerations.

Table 10-8. 5100 Gland Dimensions (Standard) — Inch

	O-ring 2-Size AS568A-	Tooled	Piston			Rod			Groove Width	
			A Bore Diameter +.002/-.000	B Groove Diameter +.000/-.002	D Piston Diameter** +.000/-.001	E Rod Diameter +.002/-.000	F Groove Diameter +.002/-.000	G Throat Diameter* +.001/-.000	C1 One Back-up +.005/-.000	C2 Two Back-up +.005/-.000
Recommended for Dynamic	006	X	0.249	0.139	0.247	0.124	0.234	0.126	0.138	0.205
	007		0.280	0.170	0.278	0.155	0.265	0.157	0.138	0.205
	008	X	0.311	0.201	0.309	0.186	0.296	0.188	0.138	0.205
	009	X	0.343	0.233	0.341	0.218	0.328	0.220	0.138	0.205
	010	X	0.374	0.264	0.372	0.249	0.359	0.251	0.138	0.205
	011	X	0.436	0.326	0.434	0.311	0.421	0.313	0.138	0.205
Not Recommended for Dynamic	012	X	0.499	0.389	0.497	0.374	0.484	0.376	0.138	0.205
	013	X	0.561	0.451	0.559	0.436	0.546	0.439	0.138	0.205
	014	X	0.624	0.514	0.622	0.499	0.609	0.501	0.138	0.205
	015	X	0.686	0.576	0.684	0.561	0.671	0.564	0.138	0.205
	016	X	0.749	0.639	0.747	0.624	0.734	0.626	0.138	0.205
	017	X	0.811	0.701	0.809	0.686	0.796	0.689	0.138	0.205
	018	X	0.874	0.764	0.872	0.749	0.856	0.751	0.138	0.205
	019	X	0.936	0.826	0.934	0.811	0.921	0.814	0.138	0.205
	020	X	0.999	0.889	0.997	0.874	0.984	0.876	0.138	0.205
	021	X	1.061	0.951	1.059	0.936	1.046	0.939	0.138	0.205
	022	X	1.124	1.014	1.122	0.999	1.109	1.001	0.138	0.205
	023	X	1.186	1.076	1.184	1.061	1.171	1.064	0.138	0.205

\*If used with wear rings, refer to wear ring throat diameter, see Section 9.

\*\*If used with wear rings, refer to wear ring piston diameter, see Section 9.

Those Piston O.D.'s shown in darker shading may cause the back-up to exceed its ability to recover from stretching. If so, select a material with greater elongation or use a two piece piston.

**Table 10-8. 5100 Gland Dimensions — Inch (Continued)**

	O-ring 2-Size AS568A-	Tooled	Piston			Rod			Groove Width	
			A Bore Diameter +.002/-.000	B Groove Diameter +.000/-.002	D Piston Diameter** +.000/-.001	E Rod Diameter +.002/0.000	F Groove Diameter +.002/0.000	G Throat Diameter* +.001/-.000	C1 One Back-up +.005/0.000	C2 Two Back-up +.005/-.000
Not Recommended for Dynamic	024	X	1.249	1.139	1.247	1.124	1.234	1.126	0.138	0.205
	025	X	1.311	1.201	1.309	1.186	1.296	1.189	0.138	0.205
	026	X	1.374	1.264	1.372	1.249	1.359	1.251	0.138	0.205
	027	X	1.436	1.326	1.434	1.311	1.421	1.313	0.138	0.205
	028	X	1.499	1.389	1.497	1.374	1.484	1.376	0.138	0.205
	029		1.624	1.514	1.622	1.499	1.609	1.501	0.138	0.205
	030		1.749	1.639	1.747	1.624	1.734	1.626	0.138	0.205
	031	X	1.874	1.764	1.872	1.749	1.859	1.751	0.138	0.205
	032		1.999	1.889	1.997	1.874	1.984	1.876	0.138	0.205
	033	X	2.124	2.014	2.122	1.999	2.109	2.001	0.138	0.205
	034		2.249	2.139	2.247	2.124	2.234	2.126	0.138	0.205
	035		2.374	2.264	2.372	2.249	2.359	2.251	0.138	0.205
	036	X	2.499	2.389	2.497	2.374	2.484	2.376	0.138	0.205
	037		2.624	2.514	2.622	2.499	2.609	2.501	0.138	0.205
	038		2.749	2.639	2.747	2.624	2.734	2.626	0.138	0.205
039		2.874	2.764	2.872	2.749	2.859	2.751	0.138	0.205	
040	X	2.999	2.889	2.997	2.874	2.984	2.876	0.138	0.205	
041		3.124	3.014	3.122	2.999	3.109	3.001	0.138	0.205	
042		3.374	3.264	3.372	3.249	3.359	3.251	0.138	0.205	
043	X	3.874	3.764	3.872	3.749	3.859	3.751	0.138	0.205	
Recommended for Dynamic	104		0.312	0.136	0.310	0.124	0.300	0.126	0.171	0.238
	105		0.343	0.167	0.341	0.155	0.331	0.157	0.171	0.238
	106		0.374	0.198	0.372	0.186	0.362	0.188	0.171	0.238
	107		0.406	0.230	0.404	0.218	0.394	0.220	0.171	0.238
	108		0.437	0.261	0.435	0.249	0.425	0.251	0.171	0.238
	109		0.499	0.323	0.497	0.311	0.487	0.313	0.171	0.238
	110	X	0.562	0.386	0.560	0.374	0.550	0.376	0.171	0.238
	111	X	0.624	0.448	0.622	0.436	0.612	0.438	0.171	0.238
	112	X	0.687	0.511	0.685	0.499	0.675	0.501	0.171	0.238
	113	X	0.749	0.573	0.747	0.561	0.737	0.563	0.171	0.238
	114	X	0.812	0.636	0.810	0.624	0.800	0.626	0.171	0.238
	115	X	0.874	0.698	0.872	0.686	0.862	0.688	0.171	0.238
116	X	0.937	0.761	0.935	0.749	0.925	0.751	0.171	0.238	
117	X	0.999	0.823	0.997	0.811	0.987	0.814	0.171	0.238	
Not Recommended for Dynamic	118	X	1.062	0.886	1.060	0.874	1.050	0.876	0.171	0.238
	119	X	1.124	0.948	1.122	0.936	1.112	0.939	0.171	0.238
	120	X	1.187	1.011	1.185	0.999	1.175	1.001	0.171	0.238
	121	X	1.249	1.073	1.247	1.061	1.237	1.063	0.171	0.238
	122	X	1.312	1.136	1.310	1.124	1.300	1.126	0.171	0.238
	123	X	1.374	1.198	1.372	1.186	1.362	1.188	0.171	0.238
	124	X	1.437	1.261	1.435	1.249	1.425	1.251	0.171	0.238
	125	X	1.499	1.323	1.497	1.311	1.487	1.313	0.171	0.238
	126	X	1.562	1.386	1.560	1.374	1.550	1.376	0.171	0.238
	127	X	1.624	1.448	1.622	1.436	1.612	1.438	0.171	0.238
	128	X	1.687	1.511	1.685	1.499	1.675	1.501	0.171	0.238
	129	X	1.749	1.573	1.747	1.561	1.737	1.563	0.171	0.238

\*If used with wear rings, refer to wear ring throat diameter, see Section 9.

\*\*If used with wear rings, refer to wear ring piston diameter, see Section 9.

Those Piston O.D.'s shown in darker shading may cause the back-up to exceed its ability to recover from stretching. If so, select a material with greater elongation or use a two piece piston.



**Table 10-8. 5100 Gland Dimensions — Inch (Continued)**

	O-ring 2-Size AS568A-	Tooled	Piston			Rod			Groove Width	
			A Bore Diameter +.002/-0.000	B Groove Diameter +.000/-0.002	D Piston Diameter** +.000/-0.001	E Rod Diameter +.002/0.000	F Groove Diameter +.002/0.000	G Throat Diameter* +.001/-0.000	C1 One Back-up +.005/0.000	C2 Two Back-up +.005/-0.000
Not Recommended for Dynamic	130		1.812	1.636	1.810	1.624	1.800	1.626	0.171	0.238
	131	X	1.874	1.698	1.872	1.686	1.862	1.688	0.171	0.238
	132	X	1.937	1.761	1.935	1.749	1.925	1.751	0.171	0.238
	133	X	1.999	1.823	1.997	1.811	1.987	1.813	0.171	0.238
	134		2.062	1.886	2.060	1.874	2.050	1.876	0.171	0.238
	135		2.124	1.948	2.122	1.936	2.112	1.938	0.171	0.238
	136		2.187	2.011	2.185	1.999	2.175	2.001	0.171	0.238
	137	X	2.249	2.073	2.247	2.061	2.237	2.063	0.171	0.238
	138		2.312	2.136	2.310	2.124	2.300	2.126	0.171	0.238
	139		2.374	2.198	2.372	2.186	2.362	2.188	0.171	0.238
	140		2.437	2.261	2.435	2.249	2.425	2.251	0.171	0.238
	141	X	2.499	2.323	2.497	2.311	2.487	2.313	0.171	0.238
	142	X	2.562	2.386	2.560	2.374	2.550	2.376	0.171	0.238
	143	X	2.624	2.448	2.622	2.436	2.612	2.438	0.171	0.238
	144	X	2.687	2.511	2.685	2.499	2.675	2.501	0.171	0.238
	145		2.749	2.573	2.747	2.561	2.737	2.563	0.171	0.238
	146		2.812	2.636	2.810	2.624	2.800	2.626	0.171	0.238
	147		2.874	2.698	2.872	2.686	2.862	2.688	0.171	0.238
	148		2.937	2.761	2.935	2.749	2.925	2.751	0.171	0.238
149	X	2.999	2.823	2.997	2.811	2.987	2.813	0.171	0.238	
Recommended for Dynamic	201		0.437	0.195	0.434	0.185	0.427	0.188	0.208	0.275
	202		0.500	0.258	0.497	0.248	0.490	0.251	0.208	0.275
	203		0.562	0.320	0.559	0.310	0.552	0.313	0.208	0.275
	204		0.625	0.383	0.622	0.373	0.615	0.376	0.208	0.275
	205		0.687	0.445	0.684	0.435	0.677	0.438	0.208	0.275
	206	X	0.750	0.508	0.747	0.498	0.740	0.501	0.208	0.275
	207		0.812	0.570	0.809	0.560	0.802	0.563	0.208	0.275
	208		0.875	0.633	0.872	0.623	0.865	0.626	0.208	0.275
	209	X	0.937	0.695	0.934	0.685	0.927	0.688	0.208	0.275
	210	X	1.000	0.758	0.997	0.748	0.990	0.751	0.208	0.275
	211	X	1.062	0.820	1.059	0.810	1.052	0.813	0.208	0.275
	212	X	1.125	0.883	1.122	0.873	1.115	0.876	0.208	0.275
	213	X	1.187	0.945	1.184	0.935	1.177	0.938	0.208	0.275
	214	X	1.250	1.008	1.247	0.998	1.240	1.001	0.208	0.275
215	X	1.312	1.070	1.309	1.060	1.302	1.063	0.208	0.275	
216	X	1.375	1.133	1.372	1.123	1.365	1.126	0.208	0.275	
217	X	1.437	1.195	1.434	1.185	1.427	1.188	0.208	0.275	
218	X	1.500	1.258	1.497	1.248	1.490	1.251	0.208	0.275	
219		1.562	1.320	1.559	1.310	1.552	1.313	0.208	0.275	
220	X	1.625	1.383	1.622	1.373	1.615	1.376	0.208	0.275	
221	X	1.687	1.445	1.684	1.435	1.677	1.438	0.208	0.275	
222	X	1.750	1.508	1.747	1.498	1.740	1.501	0.208	0.275	

\*If used with wear rings, refer to wear ring throat diameter, see Section 9.

\*\*If used with wear rings, refer to wear ring piston diameter, see Section 9.

Those Piston O.D.'s shown in darker shading may cause the back-up to exceed its ability to recover from stretching. If so, select a material with greater elongation or use a two piece piston.

Table 10-8. 5100 Gland Dimensions — Inch (Continued)

	O-ring 2-Size AS568A-	Tooled	Piston			Rod			Groove Width	
			A Bore Diameter +.002/-0.000	B Groove Diameter +.000/-0.002	D Piston Diameter** +.000/-0.001	E Rod Diameter +.002/0.000	F Groove Diameter +.002/0.000	G Throat Diameter* +.001/-0.000	C1 One Back-up +.005/0.000	C2 Two Back-up +.005/-0.000
Not Recommended for Dynamic	223	X	1.875	1.633	1.872	1.623	1.865	1.626	0.208	0.275
	224	X	2.000	1.758	1.997	1.748	1.990	1.751	0.208	0.275
	225	X	2.125	1.883	2.122	1.873	2.115	2.876	0.208	0.275
	226	X	2.250	2.008	2.247	1.998	2.240	2.001	0.208	0.275
	227	X	2.375	2.133	2.372	2.123	2.365	2.126	0.208	0.275
	228	X	2.500	2.258	2.497	2.248	2.490	2.501	0.208	0.275
	229	X	2.625	2.383	2.622	2.373	2.615	2.376	0.208	0.275
	230	X	2.750	2.508	2.747	2.498	2.740	2.501	0.208	0.275
	231	X	2.875	2.633	2.872	2.623	2.865	2.626	0.208	0.275
	232	X	3.000	2.758	2.997	2.748	2.990	2.751	0.208	0.275
	233	X	3.125	2.883	3.122	2.873	3.115	2.876	0.208	0.275
	234	X	3.250	3.008	3.247	2.998	3.240	3.001	0.208	0.275
	235		3.375	3.133	3.372	3.123	3.365	3.126	0.208	0.275
	236	X	3.500	3.258	3.497	3.248	3.490	3.251	0.208	0.275
	237	X	3.625	3.383	3.622	3.373	3.615	3.376	0.208	0.275
	238	X	3.750	3.508	3.747	3.498	3.740	3.501	0.208	0.275
	239		3.875	3.633	3.872	3.623	3.865	3.626	0.208	0.275
	240	X	4.000	3.758	3.997	3.748	3.990	3.751	0.208	0.275
	241		4.125	3.883	4.122	3.873	4.115	3.876	0.208	0.275
	242	X	4.250	4.008	4.247	3.998	4.240	4.001	0.208	0.275
	243		4.375	4.133	4.372	4.123	4.365	4.126	0.208	0.275
	244	X	4.500	4.258	4.497	4.248	4.490	4.251	0.208	0.275
	245	X	4.625	4.383	4.622	4.373	4.615	4.376	0.208	0.275
	246	X	4.750	4.508	4.747	4.498	4.740	4.501	0.208	0.275
	247	X	4.875	4.633	4.872	4.623	4.865	4.626	0.208	0.275
	248	X	5.000	4.758	4.997	4.748	4.990	4.751	0.208	0.275
	249		5.125	4.883	5.122	4.873	5.115	4.876	0.208	0.275
250	X	5.250	5.008	5.247	4.998	5.240	5.001	0.208	0.275	
251		5.375	5.133	5.372	5.123	5.365	5.126	0.208	0.275	
252	X	5.500	5.258	5.497	5.248	5.490	5.251	0.208	0.275	
253		5.625	5.383	5.622	5.373	5.615	5.376	0.208	0.275	
254		5.750	5.508	5.747	5.498	5.740	5.501	0.208	0.275	
255		5.875	5.633	5.872	5.623	5.865	5.626	0.208	0.275	
256	X	6.000	5.758	5.997	5.748	5.990	5.751	0.208	0.275	
257		6.125	5.883	6.122	5.873	6.115	5.876	0.208	0.275	
258	X	6.250	6.008	6.247	5.998	6.240	6.001	0.208	0.275	
259		6.500	6.258	6.497	6.248	6.490	6.251	0.208	0.275	
260		6.750	6.508	6.747	6.498	6.740	6.501	0.208	0.275	
261		7.000	6.758	6.997	6.748	6.990	6.751	0.208	0.275	
262		7.250	7.008	7.247	6.998	7.240	7.001	0.208	0.275	
263		7.500	7.258	7.497	7.248	7.490	7.251	0.208	0.275	
264	X	7.750	7.508	7.747	7.498	7.740	7.501	0.208	0.275	
265	X	8.000	7.758	7.997	7.748	7.990	7.751	0.208	0.275	
277	X	11.750	11.508	11.747	11.498	11.740	11.501	0.208	0.275	

\*If used with wear rings, refer to wear ring throat diameter, see Section 9.

\*\*If used with wear rings, refer to wear ring piston diameter, see Section 9.

Those Piston O.D.'s shown in darker shading may cause the back-up to exceed its ability to recover from stretching. If so, select a material with greater elongation or use a two piece piston.

Table 10-8. 5100 Gland Dimensions — Inch (Continued)

	O-ring 2-Size AS568A-	Tooled	Piston			Rod			Groove Width	
			A Bore Diameter +.002/-0.000	B Groove Diameter +.000/-0.002	D Piston Diameter** +.000/-0.001	E Rod Diameter +.002/.000	F Groove Diameter +.002/.000	G Throat Diameter* +.001/-0.000	C1 One Back-up +.005/.000	C2 Two Back-up +.005/-0.000
Recommended for Dynamic	309	X	0.812	0.442	0.809	0.435	0.805	0.438	0.311	0.410
	310	X	0.875	0.505	0.872	0.498	0.868	0.501	0.311	0.410
	311		0.937	0.567	0.934	0.560	0.930	0.563	0.311	0.410
	312		1.000	0.630	0.997	0.623	0.993	0.626	0.311	0.410
	313		1.062	0.692	1.059	0.685	1.055	0.688	0.311	0.410
	314	X	1.125	0.755	1.122	0.748	1.118	0.751	0.311	0.410
	315		1.187	0.817	1.184	0.810	1.180	0.813	0.311	0.410
Recommended for Dynamic	316	X	1.250	0.880	1.247	0.873	1.243	0.876	0.311	0.410
	317		1.312	0.942	1.309	0.935	1.305	0.938	0.311	0.410
	318	X	1.375	1.005	1.372	0.998	1.368	1.001	0.311	0.410
	319		1.437	1.067	1.434	1.060	1.430	1.063	0.311	0.410
	320		1.500	1.130	1.497	1.123	1.493	1.126	0.311	0.410
	321		1.562	1.192	1.559	1.185	1.555	1.188	0.311	0.410
	322	X	1.625	1.255	1.622	1.248	1.618	1.251	0.311	0.410
	323		1.687	1.317	1.684	1.310	1.680	1.313	0.311	0.410
	324		1.750	1.380	1.747	1.373	1.743	1.376	0.311	0.410
	325	X	1.875	1.505	1.872	1.498	1.868	1.501	0.311	0.410
	326	X	2.000	1.630	1.997	1.623	1.993	1.626	0.311	0.410
	327	X	2.125	1.755	2.122	1.748	2.118	1.751	0.311	0.410
	328	X	2.250	1.880	2.247	1.873	2.243	1.876	0.311	0.410
	329	X	2.375	2.005	2.372	1.998	2.368	2.001	0.311	0.410
	330	X	2.500	2.130	2.497	2.123	2.493	2.126	0.311	0.410
	331	X	2.625	2.255	2.622	2.248	2.618	2.251	0.311	0.410
	332	X	2.750	2.380	2.747	2.373	2.743	2.376	0.311	0.410
	333	X	2.875	2.505	2.872	2.498	2.868	2.501	0.311	0.410
	334	X	3.000	2.630	2.997	2.623	2.993	2.626	0.311	0.410
	335	X	3.125	2.755	3.122	2.748	3.118	2.751	0.311	0.410
	336	X	3.250	2.880	3.247	2.873	3.243	2.876	0.311	0.410
	337	X	3.375	3.005	3.372	2.998	3.368	3.001	0.311	0.410
	338	X	3.500	3.130	3.497	3.123	3.493	3.126	0.311	0.410
	339	X	3.625	3.255	3.622	3.248	3.618	3.251	0.311	0.410
	340	X	3.750	3.380	3.747	3.373	3.743	3.376	0.311	0.410
	341	X	3.875	3.505	3.872	3.498	3.868	3.501	0.311	0.410
	342	X	4.000	3.630	3.997	3.623	3.993	3.626	0.311	0.410
	343	X	4.125	3.755	4.122	3.748	4.118	3.751	0.311	0.410
	344	X	4.250	3.880	4.247	3.873	4.243	3.876	0.311	0.410
	345	X	4.375	4.005	4.372	3.998	4.368	4.001	0.311	0.410
	346	X	4.500	4.130	4.497	4.123	4.493	4.126	0.311	0.410
	347	X	4.625	4.255	4.622	4.248	4.618	4.251	0.311	0.410
	348	X	4.750	4.380	4.747	4.373	4.743	4.376	0.311	0.410
349	X	4.875	4.505	4.872	4.498	4.868	4.501	0.311	0.410	

\*If used with wear rings, refer to wear ring throat diameter, see Section 9.

\*\*If used with wear rings, refer to wear ring piston diameter, see Section 9.

Those Piston O.D.'s shown in darker shading may cause the back-up to exceed its ability to recover from stretching. If so, select a material with greater elongation or use a two piece piston.



Table 10-8. 5100 Gland Dimensions — Inch (Continued)

	O-ring 2-Size AS568A-	Tooled	Piston			Rod			Groove Width	
			A Bore Diameter +.002/-.000	B Groove Diameter +.000/-.002	D Piston Diameter** +.000/-.001	E Rod Diameter +.002/-.000	F Groove Diameter +.002/-.000	G Throat Diameter* +.001/-.000	C1 One Back-up +.005/-.000	C2 Two Back-up +.005/-.000
Not Recommended for Dynamic	350		5.000	4.630	4.997	4.623	4.993	4.626	0.311	0.410
	351		5.125	4.755	5.122	4.748	5.118	4.751	0.311	0.410
	352	X	5.250	4.880	5.247	4.873	5.243	4.876	0.311	0.410
	353		5.375	5.005	5.372	4.998	5.368	5.001	0.311	0.410
	354	X	5.500	5.130	5.497	5.123	5.493	5.126	0.311	0.410
	355		5.625	5.255	5.622	5.248	5.618	5.251	0.311	0.410
	356		5.750	5.380	5.747	5.373	5.743	5.376	0.311	0.410
	357		5.875	5.505	5.872	5.498	5.868	5.501	0.311	0.410
	358	X	6.000	5.630	5.997	5.623	5.993	5.626	0.311	0.410
	359		6.125	5.755	6.122	5.748	6.118	5.751	0.311	0.410
	360		6.250	5.880	6.247	5.873	6.243	5.876	0.311	0.410
361	X	6.375	6.005	6.372	5.998	6.368	6.001	0.311	0.410	
Recommended for Dynamic	425	X	5.002	4.528	4.998	4.497	4.971	4.501	0.408	0.538
	426		5.127	4.653	5.123	4.622	5.096	4.626	0.408	0.538
	427		5.252	4.778	5.248	4.747	5.221	4.751	0.408	0.538
	428		5.377	4.903	5.373	4.872	5.346	4.876	0.408	0.538
	429	X	5.502	5.028	5.498	4.997	5.471	5.001	0.408	0.538
	430		5.627	5.153	5.623	5.122	5.596	5.126	0.408	0.538
	431		5.752	5.278	5.748	5.247	5.721	5.251	0.408	0.538
	432	X	5.877	5.403	5.873	5.372	5.846	5.376	0.408	0.538
	433	X	6.002	5.528	5.998	5.497	5.971	5.501	0.408	0.538
	434		6.127	5.653	6.123	5.622	6.096	5.626	0.408	0.538
	435		6.252	5.778	6.248	5.747	6.221	5.751	0.408	0.538
	436		6.377	5.903	6.373	5.872	6.346	5.876	0.408	0.538
	437	X	6.502	6.028	6.498	5.997	6.471	6.001	0.408	0.538
	438		6.752	6.278	6.748	6.247	6.721	6.251	0.408	0.538
	439	X	7.002	6.528	6.998	6.497	6.971	6.501	0.408	0.538
	440		7.252	6.778	7.248	6.747	7.221	6.751	0.408	0.538
	441		7.502	7.028	7.498	6.997	7.471	7.001	0.408	0.538
	442		7.752	7.278	7.748	7.247	7.721	7.251	0.408	0.538
	443	X	8.002	7.528	7.998	7.497	7.971	7.501	0.408	0.538
	444		8.252	7.778	8.248	7.747	8.221	7.751	0.408	0.538
	445		8.502	8.028	8.498	7.997	8.471	8.001	0.408	0.538
	446	X	9.002	8.528	8.998	8.497	8.971	8.501	0.408	0.538
	447		9.502	9.028	9.498	8.997	9.471	9.001	0.408	0.538
448		10.002	9.528	9.998	9.497	9.971	9.501	0.408	0.538	
449		10.502	10.028	10.498	9.997	10.471	10.001	0.408	0.538	
450		11.002	10.528	10.998	10.497	10.971	10.501	0.408	0.538	
451	X	11.502	11.028	11.498	10.997	11.471	11.001	0.408	0.538	
452		12.002	11.528	11.998	11.497	11.971	11.501	0.408	0.538	
453	X	12.502	12.028	12.498	11.997	12.471	12.001	0.408	0.538	

\*If used with wear rings, refer to wear ring throat diameter, see Section 9.

\*\*If used with wear rings, refer to wear ring piston diameter, see Section 9.

Those Piston O.D.'s shown in darker shading may cause the back-up to exceed its ability to recover from stretching. If so, select a material with greater elongation or use a two piece piston.

**Table 10-8. 5100 Gland Dimensions — Inch (Continued)**

	O-ring 2-Size AS568A-	Tooled	Piston			Rod			Groove Width	
			A Bore Diameter +.002/-0.000	B Groove Diameter +.000/-0.002	D Piston Diameter** +.000/-0.001	E Rod Diameter +.002/.000	F Groove Diameter +.002/.000	G Throat Diameter* +.001/-0.000	C1 One Back-up +.005/.000	C2 Two Back-up +.005/-0.000
Recommended for Dynamic	454		13.002	12.528	12.998	12.497	12.971	12.501	0.408	0.538
	455		13.502	13.028	13.498	12.997	13.471	13.001	0.408	0.538
	456		14.002	13.528	13.998	13.497	13.971	13.501	0.408	0.538
	457		14.502	14.028	14.498	13.997	14.471	14.001	0.408	0.538
	458		15.002	14.528	14.998	14.497	14.971	14.501	0.408	0.538
	459		15.502	15.028	15.498	14.997	15.471	15.001	0.408	0.538
Not Recommended for Dynamic	460		16.002	15.528	15.998	15.497	15.971	15.501	0.408	0.538
	461		16.502	16.028	16.498	15.997	16.471	16.001	0.408	0.538
	462		17.002	16.528	16.998	16.497	16.971	16.501	0.408	0.538
	463		17.502	17.028	17.498	16.997	17.471	17.001	0.408	0.538
	464		18.002	17.528	17.998	17.497	17.971	17.501	0.408	0.538
	465		18.502	18.028	18.498	17.997	18.471	18.001	0.408	0.538
	466	X	19.002	18.528	18.998	18.497	18.971	18.501	0.408	0.538
	467		19.502	19.028	19.498	18.997	19.471	19.001	0.408	0.538
	468		20.002	19.528	19.998	19.497	19.971	19.501	0.408	0.538
	469		20.502	20.028	20.498	19.997	20.471	20.001	0.408	0.538
	470		21.502	21.028	21.498	20.997	21.471	21.001	0.408	0.538
	471		22.502	22.028	22.498	21.997	22.471	22.001	0.408	0.538
	472	X	23.502	23.028	23.498	22.997	23.471	23.001	0.408	0.538
	473		24.502	24.028	24.498	23.997	24.471	24.001	0.408	0.538
474		25.502	25.028	25.498	24.997	25.471	25.001	0.408	0.538	
475	X	26.502	26.028	26.498	25.997	26.471	26.001	0.408	0.538	

\*If used with wear rings, refer to wear ring throat diameter, see Section 9.

\*\*If used with wear rings, refer to wear ring piston diameter, see Section 9.

Those Piston O.D.'s shown in darker shading may cause the back-up to exceed its ability to recover from stretching. If so, select a material with greater elongation or use a two piece piston.

NOTE: For sizes larger than those shown in the table, please contact your local Parker Seal representative.

# Back-up Ring PAB Profile



## PAB Profile, Positively-Actuated Back-up

While modular back-ups require an increase in groove width to be incorporated into the sealing system, because they are integrated with the seal positively-actuated back-ups do not change the required axial groove width. For many profiles, these back-ups can provide the ultimate extrusion resistance while retaining the seal's original groove dimensions. While the most common material used to manufacture positively-actuated back-ups is nylon, it is not uncommon to see applications that require materials such as UltraCOMP, PTFE or polyacetal.

Due to the nature of this product line and the design relationship between the back-up and the seal, parts are sold only as part of an assembly that includes the seal design best suited to the application.

Positively-actuated back-ups can be incorporated into profiles such as the BPP and BD. Tooling may be required.

## Technical Data

Standard Materials*	Temperature	Max. Pressure Range**
<b>Rod</b>		
R0 (Virgin PTFE)	-65°F to 250°F (-54°C to 121°C)	5,000 psi (344 bar)
R1 (Nylatron)	-20°F to 250°F (-29°C to 121°C)	3,000 psi (206 bar)
R12 (PEEK)	-65°F to 500°F (-54°C to 260°C)	10,000 psi (689 bar)
<b>Piston</b>		
P0 (Virgin PTFE)	-65°F to 250°F (-54°C to 121°C)	5,000 psi (344 bar)
P1 (Nylatron)	-20°F to 250°F (-29°C to 121°C)	3,000 psi (206 bar)
P12 (PEEK)	-65°F to 500°F (-54°C to 260°C)	10,000 psi (689 bar)

\* **Alternate Materials:** For applications that may require an alternate material, please contact your local Parker Seal representative.

\*\* 7,000 psi (482 bar) with tight-tolerance wear rings.  
5,000 psi (344 bar) with standard-tolerance wear rings.

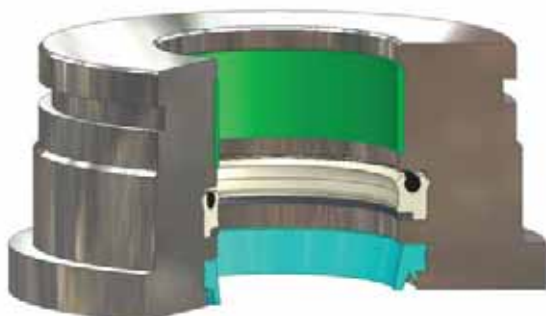
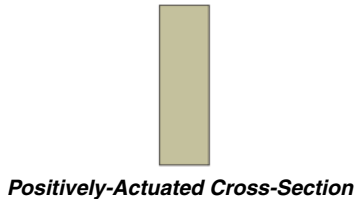

Positively-Actuated installed in Rod Gland

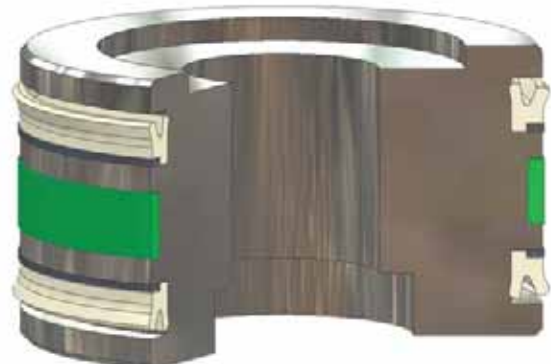

Positively-Actuated installed in Piston Gland

# Back-up Ring PDB Profile

Catalog EPS 5370/USA

## PDB Profile, PTFE Modular Back-up



PDB back-ups are PTFE anti-extrusion rings. The PDBA and PDBB profiles are designed to retrofit MIL Spec grooves used in commercial applications. PDBA styles are split rings retrofitting MS28774 designs, while PDBB styles are solid rings retrofitting MS27595 designs. Due to the fact that these profiles are designed to commercial grooves, MIL Spec certifications are not available. Although the standard material is virgin PTFE, any of Parker's available PTFE blends can be used.

## Technical Data

### Standard

#### Materials\*

0100 Virgin PTFE

#### Temperature

-425°F to 450°F  
(-254°C to 232°C)

#### Max. Pressure Range

1,500 psi (103 bar) dynamic  
4,500 psi (310 bar) static

**\*Alternate Materials:** For applications that may require an alternate material, please see Section 3 (Table 3-7) for alternate PTFE materials.



*PDB Cross-Section*

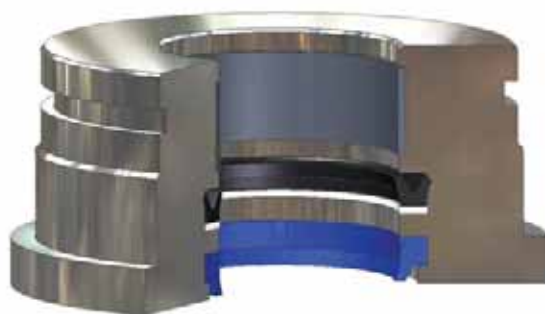

*PDB installed in Rod Gland*



*PDB installed in Piston Gland*

10

09/01/07



10-22

[www.parkerseals.com](http://www.parkerseals.com)

**Parker Hannifin Corporation**  
Engineered Polymer Systems Division  
Phone: 801 972 3000

### Part Number Nomenclature — PDBA Profile

Table 10-9. PDBA Profile — Inch

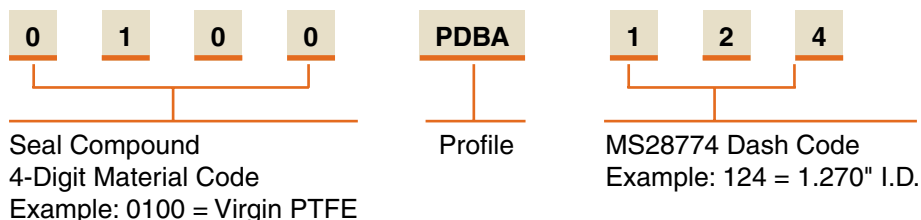

### Gland Dimensions — PDBA Profile

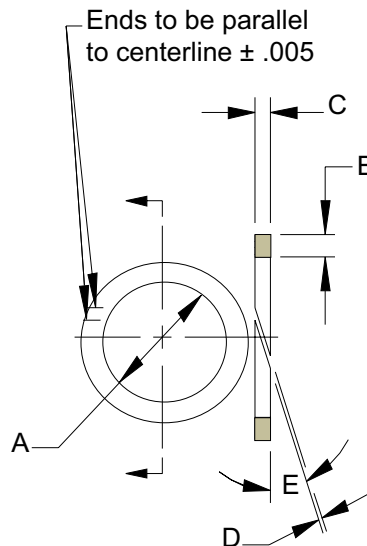

Please refer to Engineering Section 2, page 2-8 for surface finish and additional hardware considerations.

Table 10-10. PDBA Gland Dimensions — Inch

Dash Number MS28774	Seal Dimensions				
	A Inside Diameter	B Radial Cross- Section	C Width	D Split Gap	E Split Angle Degree
	+.001/ -.001				
004	0.109	.052/.054	.045/.052	.000/.005	39
005	0.124	.052/.054	.045/.052	.000/.005	33
006	0.140	.052/.054	.045/.052	.000/.005	30
007	0.171	.052/.054	.045/.052	.000/.005	26
008	0.202	.052/.054	.045/.052	.000/.005	22
009	0.234	.052/.054	.045/.052	.000/.005	22
010	0.265	.052/.054	.045/.052	.000/.005	22
011	0.327	.052/.054	.045/.052	.000/.005	22
012	0.390	.052/.054	.045/.052	.000/.005	22
013	0.455	.052/.054	.045/.052	.000/.005	22
014	0.518	.052/.054	.045/.052	.000/.005	22
015	0.580	.052/.054	.045/.052	.000/.005	22
016	0.643	.052/.054	.045/.052	.000/.005	22
017	0.705	.052/.054	.045/.052	.000/.005	22
018	0.768	.052/.054	.045/.052	.000/.005	22
019	0.830	.052/.054	.045/.052	.000/.005	22
020	0.898	.052/.054	.045/.052	.000/.005	22
021	0.960	.052/.054	.045/.052	.000/.005	22

NOTE: Measure Split Gap using a Mandrel with "A" Diameter.

Dash Number MS28774	Seal Dimensions				
	A Inside Diameter	B Radial Cross- Section	C Width	D Split Gap	E Split Angle Degree
	+.001/ -.001				
022	1.023	.052/.054	.045/.052	.000/.005	22
023	1.085	.052/.054	.045/.052	.000/.005	22
024	1.148	.052/.054	.045/.052	.000/.005	22
025	1.210	.052/.054	.045/.052	.000/.005	22
026	1.273	.052/.054	.045/.052	.000/.005	22
027	1.335	.052/.054	.045/.052	.000/.005	22
028	1.398	.052/.054	.045/.052	.000/.005	22
110	0.390	.085/.087	.045/.052	.000/.006	22
111	0.452	.085/.087	.045/.052	.000/.006	22
112	0.515	.085/.087	.045/.052	.000/.006	22
113	0.577	.085/.087	.045/.052	.000/.006	22
114	0.640	.085/.087	.045/.052	.000/.006	22
115	0.702	.085/.087	.045/.052	.000/.006	22
116	0.765	.085/.087	.045/.052	.000/.006	22
117	0.832	.085/.087	.045/.052	.000/.006	22
118	0.895	.085/.087	.045/.052	.000/.006	22
119	0.957	.085/.087	.045/.052	.000/.006	22
120	1.020	.085/.087	.045/.052	.000/.006	22

NOTE: Measure Split Gap using a Mandrel with "A" Diameter.

09/01/07

**Table 10-10. PDBA Gland Dimensions — Inch (Continued)**

Dash Number MS28774	Seal Dimensions				
	A Inside Diameter	B Radial Cross- Section	C Width	D Split Gap	E Split Angle Degree
	+0.001/ -.001				
121	1.082	.085/.087	.045/.052	.000/.006	22
122	1.145	.085/.087	.045/.052	.000/.006	22
123	1.207	.085/.087	.045/.052	.000/.006	22
124	1.270	.085/.087	.045/.052	.000/.006	22
125	1.332	.085/.087	.045/.052	.000/.006	22
126	1.397	.085/.087	.045/.052	.000/.006	22
127	1.459	.085/.087	.045/.052	.000/.006	22
128	1.522	.085/.087	.045/.052	.000/.006	22
129	1.584	.085/.087	.045/.052	.000/.006	22
130	1.647	.085/.087	.045/.052	.000/.006	22
131	1.709	.085/.087	.045/.052	.000/.006	22
132	1.772	.085/.087	.045/.052	.000/.006	22
133	1.934	.085/.087	.045/.052	.000/.006	22
134	1.897	.085/.087	.045/.052	.000/.006	22
135	1.959	.085/.087	.045/.052	.000/.006	22
136	2.022	.085/.087	.045/.052	.000/.006	22
137	2.084	.085/.087	.045/.052	.000/.006	22
138	2.147	.085/.087	.045/.052	.000/.006	22
139	2.209	.085/.087	.045/.052	.000/.006	22
140	2.258	.085/.087	.045/.052	.000/.006	22
141	2.320	.085/.087	.045/.052	.000/.006	22
142	2.383	.085/.087	.045/.052	.000/.006	22
143	2.445	.085/.087	.045/.052	.000/.006	22
144	2.508	.085/.087	.045/.052	.000/.006	22
145	2.570	.085/.087	.045/.052	.000/.006	22
146	2.633	.085/.087	.045/.052	.000/.006	22
147	2.695	.085/.087	.045/.052	.000/.006	22
148	2.758	.085/.087	.045/.052	.000/.006	22
149	2.820	.085/.087	.045/.052	.000/.006	22
210	0.766	.118/.120	.045/.052	.000/.006	22
211	0.828	.118/.120	.045/.052	.000/.006	22
212	0.891	.118/.120	.045/.052	.000/.006	22
213	0.953	.118/.120	.045/.052	.000/.006	22
214	1.016	.118/.120	.045/.052	.000/.006	22
215	1.078	.118/.120	.045/.052	.000/.006	22
216	1.141	.118/.120	.045/.052	.000/.006	22
217	1.203	.118/.120	.045/.052	.000/.006	22
218	1.266	.118/.120	.045/.052	.000/.006	22
219	1.344	.118/.120	.045/.052	.000/.006	22
220	1.397	.118/.120	.045/.052	.000/.006	22
221	1.459	.118/.120	.045/.052	.000/.006	22
222	1.522	.118/.120	.045/.052	.000/.006	22
223	1.647	.118/.120	.045/.052	.000/.007	22
224	1.772	.118/.120	.045/.052	.000/.007	22
225	1.897	.118/.120	.045/.052	.000/.007	22
226	2.022	.118/.120	.045/.052	.000/.007	22

NOTE: Measure Split Gap using a Mandrel with "A" Diameter.

Dash Number MS28774	Seal Dimensions				
	A Inside Diameter	B Radial Cross- Section	C Width	D Split Gap	E Split Angle Degree
	+0.001/ -.001				
227	2.147	.118/.120	.045/.052	.000/.007	22
228	2.272	.118/.120	.045/.052	.000/.007	22
229	2.397	.118/.120	.045/.052	.000/.007	22
230	2.522	.118/.120	.045/.052	.000/.007	22
231	2.631	.118/.120	.045/.052	.000/.007	22
232	2.756	.118/.120	.045/.052	.000/.007	22
233	2.881	.118/.120	.045/.052	.000/.007	22
234	3.006	.118/.120	.045/.052	.000/.007	22
235	3.131	.118/.120	.045/.052	.000/.007	22
236	3.256	.118/.120	.045/.052	.000/.007	22
237	3.381	.118/.120	.045/.052	.000/.007	22
238	3.506	.118/.120	.045/.052	.000/.007	22
239	3.631	.118/.120	.045/.052	.000/.007	22
240	3.756	.118/.120	.045/.052	.000/.007	22
241	3.881	.118/.120	.045/.052	.000/.007	22
242	4.006	.118/.120	.045/.052	.000/.007	22
243	4.131	.118/.120	.045/.052	.000/.007	22
244	4.256	.118/.120	.045/.052	.000/.007	22
245	4.381	.118/.120	.045/.052	.000/.007	22
246	4.506	.118/.120	.045/.052	.000/.007	22
247	4.631	.118/.120	.045/.052	.000/.007	22
325	1.513	.182/.184	.065/.075	.000/.007	22
326	1.638	.182/.184	.065/.075	.000/.007	22
327	1.763	.182/.184	.065/.075	.000/.007	22
328	1.888	.182/.184	.065/.075	.000/.007	22
329	2.013	.182/.184	.065/.075	.000/.007	22
330	2.138	.182/.184	.065/.075	.000/.007	22
331	2.268	.182/.184	.065/.075	.000/.007	22
332	2.393	.182/.184	.065/.075	.000/.007	22
333	2.518	.182/.184	.065/.075	.000/.007	22
334	2.643	.182/.184	.065/.075	.000/.007	22
335	2.768	.182/.184	.065/.075	.000/.007	22
336	2.893	.182/.184	.065/.075	.000/.007	22
337	3.018	.182/.184	.065/.075	.000/.007	22
338	3.143	.182/.184	.065/.075	.000/.007	22
339	3.273	.182/.184	.065/.075	.000/.007	22
340	3.398	.182/.184	.065/.075	.000/.007	22
341	3.523	.182/.184	.065/.075	.000/.007	22
342	3.648	.182/.184	.065/.075	.000/.007	22
343	3.773	.182/.184	.065/.075	.000/.007	22
344	3.898	.182/.184	.065/.075	.000/.007	22
345	4.028	.182/.184	.065/.075	.000/.007	22
346	4.153	.182/.184	.065/.075	.000/.007	22
347	4.278	.182/.184	.065/.075	.000/.007	22
348	4.403	.182/.184	.065/.075	.000/.007	22
349	4.528	.182/.184	.065/.075	.000/.007	22

NOTE: Measure Split Gap using a Mandrel with "A" Diameter.

Table 10-10. PDBA Gland Dimensions — Inch (Continued)

Dash Number MS28774	Seal Dimensions				
	A Inside Diameter	B Radial Cross- Section	C Width	D Split Gap	E Split Angle Degree
	+0.001/ -0.001				
425	4.551	.235/.237	.106/.110	.000/.008	22
426	4.676	.235/.237	.106/.110	.000/.008	22
427	4.801	.235/.237	.106/.110	.000/.008	22
428	4.926	.235/.237	.106/.110	.000/.008	22
429	5.051	.235/.237	.106/.110	.000/.008	22
430	5.176	.235/.237	.106/.110	.000/.008	22
431	5.301	.235/.237	.106/.110	.000/.008	22
432	5.426	.235/.237	.106/.110	.000/.008	22
433	5.551	.235/.237	.106/.110	.000/.008	22
434	5.676	.235/.237	.106/.110	.000/.008	22
435	5.801	.235/.237	.106/.110	.000/.008	22
436	5.926	.235/.237	.106/.110	.000/.008	22
437	6.051	.235/.237	.106/.110	.000/.008	22
438	6.274	.235/.237	.106/.110	.000/.008	22
439	6.524	.235/.237	.106/.110	.000/.008	22
440	6.774	.235/.237	.106/.110	.000/.008	22
441	7.024	.235/.237	.106/.110	.000/.008	22
442	7.274	.235/.237	.106/.110	.000/.008	22

NOTE: Measure Split Gap using a Mandrel with "A" Diameter.

Dash Number MS28774	Seal Dimensions				
	A Inside Diameter	B Radial Cross- Section	C Width	D Split Gap	E Split Angle Degree
	+0.001/ -0.001				
443	7.524	.235/.237	.106/.110	.000/.008	22
444	7.774	.235/.237	.106/.110	.000/.008	22
445	8.024	.235/.237	.106/.110	.000/.008	22
446	8.524	.235/.237	.106/.110	.000/.008	22
447	9.024	.235/.237	.106/.110	.000/.008	22
448	9.524	.235/.237	.106/.110	.000/.008	22
449	10.024	.235/.237	.106/.110	.000/.008	22
450	10.524	.235/.237	.106/.110	.000/.008	22
451	11.024	.235/.237	.106/.110	.000/.008	22
452	11.524	.235/.237	.106/.110	.000/.008	22
453	12.024	.235/.237	.106/.110	.000/.008	22
454	12.524	.235/.237	.106/.110	.000/.008	22
455	13.024	.235/.237	.106/.110	.000/.008	22
456	13.524	.235/.237	.106/.110	.000/.008	22
457	14.024	.235/.237	.106/.110	.000/.008	22
458	14.524	.235/.237	.106/.110	.000/.008	22
459	15.024	.235/.237	.106/.110	.000/.008	22
460	15.524	.235/.237	.106/.110	.000/.008	22

NOTE: Measure Split Gap using a Mandrel with "A" Diameter.

NOTE: For sizes larger than those shown in the table, please contact your local Parker Seal representative.



**PDB Profile**

**Part Number Nomenclature — PDBB Profile**

Table 10-11. PDBB Profile — Inch

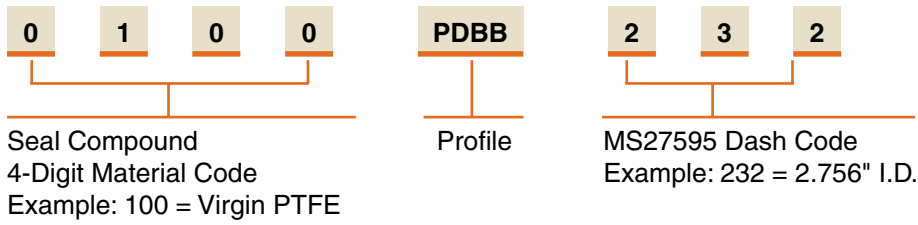

**Gland Dimensions — PDBB Profile**

Please refer to Engineering Section 2, page 2-8 for surface finish and additional hardware considerations.

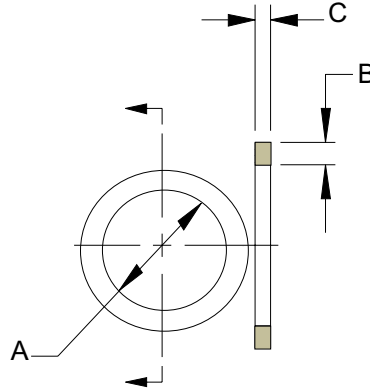

Table 10-12. PDBB Gland Dimensions — Inch

Dash Number MS27595	Seal Dimensions		
	A I.D.	B Radial Cross- Section	C Width
	+.001/ -.000		
004	0.080	.048/.052	.054/.056
005	0.111	.048/.052	.054/.056
006	0.125	.048/.052	.054/.056
007	0.156	.048/.052	.054/.056
008	0.187	.048/.052	.054/.056
009	0.219	.048/.052	.054/.056
010	0.250	.048/.052	.054/.056
011	0.312	.048/.052	.054/.056
012	0.375	.048/.052	.054/.056
013	0.440	.048/.052	.054/.056
014	0.503	.048/.052	.054/.056
015	0.565	.048/.052	.054/.056
016	0.628	.048/.052	.054/.056
017	0.690	.048/.052	.054/.056
018	0.753	.048/.052	.054/.056
019	0.815	.048/.052	.054/.056
020	0.881	.048/.052	.054/.056
	+.002/ -.002		
021	0.943	.048/.052	.054/.056
022	1.006	.048/.052	.054/.056
023	1.068	.048/.052	.054/.056
024	1.131	.048/.052	.054/.056
025	1.193	.048/.052	.054/.056

Dash Number MS27595	Seal Dimensions		
	A I.D.	B Radial Cross- Section	C Width
	+.002/ -.002		
026	1.256	.048/.052	.054/.056
027	1.318	.048/.052	.054/.056
028	1.381	.048/.052	.054/.056
	+.001/ -.002		
110	0.374	.048/.052	.087/.089
111	0.437	.048/.052	.087/.089
112	0.499	.048/.052	.087/.089
113	0.562	.048/.052	.087/.089
114	0.624	.048/.052	.087/.089
115	0.687	.048/.052	.087/.089
116	0.749	.048/.052	.087/.089
117	0.815	.048/.052	.087/.089
118	0.877	.048/.052	.087/.089
119	0.940	.048/.052	.087/.089
120	1.002	.048/.052	.087/.089
	+.002/ -.002		
121	1.065	.048/.052	.087/.089
122	1.127	.048/.052	.087/.089
123	1.190	.048/.052	.087/.089
124	1.252	.048/.052	.087/.089
125	1.315	.048/.052	.087/.089
126	1.377	.048/.052	.087/.089

Dash Number MS27595	Seal Dimensions		
	A I.D.	B Radial Cross- Section	C Width
	+.002/ -.002		
127	1.440	.048/.052	.087/.089
128	1.502	.048/.052	.087/.089
129	1.565	.048/.052	.087/.089
130	1.629	.048/.052	.087/.089
131	1.691	.048/.052	.087/.089
132	1.754	.048/.052	.087/.089
133	1.816	.048/.052	.087/.089
134	1.879	.048/.052	.087/.089
135	1.942	.048/.052	.087/.089
136	2.004	.048/.052	.087/.089
137	2.067	.048/.052	.087/.089
138	2.129	.048/.052	.087/.089
139	2.192	.048/.052	.087/.089
140	2.254	.048/.052	.087/.089
141	2.317	.048/.052	.087/.089
142	2.379	.048/.052	.087/.089
143	2.442	.048/.052	.087/.089
144	2.504	.048/.052	.087/.089
145	2.567	.048/.052	.087/.089
146	2.629	.048/.052	.087/.089
147	2.692	.048/.052	.087/.089
148	2.754	.048/.052	.087/.089
149	2.817	.048/.052	.087/.089

09/01/07

Table 10-12. PDBB Gland Dimensions — Inch (Continued)

Dash Number MS27595	Seal Dimensions			Dash Number MS27595	Seal Dimensions			Dash Number MS27595	Seal Dimensions		
	A I.D.	B Radial Cross- Section	C Width		A I.D.	B Radial Cross- Section	C Width		A I.D.	B Radial Cross- Section	C Width
	+0.01/ -0.02				+0.01/ -0.02				+0.02/ -0.00		
210	0.753	.048/.052	.118/.120	246	4.505	.048/.052	.118/.120	432	5.377	.106/.110	.235/.237
211	0.815	.048/.052	.118/.120	247	4.630	.048/.052	.118/.120	433	5.502	.106/.110	.235/.237
212	0.878	.048/.052	.118/.120	325	1.497	.071/.075	.184/.186	434	5.627	.106/.110	.235/.237
213	0.940	.048/.052	.118/.120	326	1.622	.071/.075	.184/.186	435	5.752	.106/.110	.235/.237
214	1.003	.048/.052	.118/.120	327	1.748	.071/.075	.184/.186	436	5.877	.106/.110	.235/.237
215	1.065	.048/.052	.118/.120	328	1.873	.071/.075	.184/.186	437	6.002	.106/.110	.235/.237
216	1.128	.048/.052	.118/.120	329	1.998	.071/.075	.184/.186	438	6.252	.106/.110	.235/.237
217	1.190	.048/.052	.118/.120	330	2.123	.071/.075	.184/.186	439	6.502	.106/.110	.235/.237
218	1.253	.048/.052	.118/.120	331	2.248	.071/.075	.184/.186	440	6.752	.106/.110	.235/.237
219	1.315	.048/.052	.118/.120	332	2.373	.071/.075	.184/.186	441	7.002	.106/.110	.235/.237
220	1.378	.048/.052	.118/.120	333	2.498	.071/.075	.184/.186	442	7.252	.106/.110	.235/.237
221	1.440	.048/.052	.118/.120	334	2.623	.071/.075	.184/.186	443	7.502	.106/.110	.235/.237
222	1.503	.048/.052	.118/.120	335	2.748	.071/.075	.184/.186	444	7.752	.106/.110	.235/.237
223	1.629	.048/.052	.118/.120	336	2.873	.071/.075	.184/.186	445	8.002	.106/.110	.235/.237
224	1.754	.048/.052	.118/.120	337	2.998	.071/.075	.184/.186		+0.03/ -0.03		
225	1.880	.048/.052	.118/.120	338	3.123	.071/.075	.184/.186	446	8.502	.106/.110	.235/.237
226	2.005	.048/.052	.118/.120	339	3.248	.071/.075	.184/.186	447	9.002	.106/.110	.235/.237
227	2.130	.048/.052	.118/.120	340	3.373	.071/.075	.184/.186	448	9.502	.106/.110	.235/.237
228	2.255	.048/.052	.118/.120	341	3.498	.071/.075	.184/.186	449	10.002	.106/.110	.235/.237
229	2.380	.048/.052	.118/.120	342	3.623	.071/.075	.184/.186	450	10.502	.106/.110	.235/.237
230	2.505	.048/.052	.118/.120	343	3.748	.071/.075	.184/.186		+0.04/ -0.04		
231	2.630	.048/.052	.118/.120	344	3.873	.071/.075	.184/.186	451	11.002	.106/.110	.235/.237
232	2.755	.048/.052	.118/.120	345	3.998	.071/.075	.184/.186	452	11.502	.106/.110	.235/.237
233	2.880	.048/.052	.118/.120	346	4.123	.071/.075	.184/.186	453	12.002	.106/.110	.235/.237
234	3.005	.048/.052	.118/.120	347	4.248	.071/.075	.184/.186	454	12.502	.106/.110	.235/.237
235	3.130	.048/.052	.118/.120	348	4.373	.071/.075	.184/.186	455	13.002	.106/.110	.235/.237
236	3.255	.048/.052	.118/.120	349	4.498	.071/.075	.184/.186		+0.05/ -0.05		
237	3.380	.048/.052	.118/.120		+0.02/ -0.00			456	13.502	.106/.110	.235/.237
238	3.505	.048/.052	.118/.120	425	4.502	.106/.110	.235/.237	457	14.002	.106/.110	.235/.237
239	3.630	.048/.052	.118/.120	426	4.627	.106/.110	.235/.237	458	14.502	.106/.110	.235/.237
240	3.755	.048/.052	.118/.120	427	4.752	.106/.110	.235/.237	459	15.002	.106/.110	.235/.237
241	3.880	.048/.052	.118/.120	428	4.877	.106/.110	.235/.237	460	15.502	.106/.110	.235/.237
242	4.005	.048/.052	.118/.120	429	5.002	.106/.110	.235/.237				
243	4.130	.048/.052	.118/.120	430	5.127	.106/.110	.235/.237				
244	4.255	.048/.052	.118/.120	431	5.252	.106/.110	.235/.237				
245	4.380	.048/.052	.118/.120								

NOTE: For sizes larger than those shown in the table, please contact your local Parker Seal representative.



# Urethane O-rings & Head Seals

## Contents

Product Profiles  
 568 Resilon O-ring ..... 11-2  
 HS Head Seal..... 11-15

## Urethane O-rings & Head Seals

Parker offers many materials for fluid power applications that have unique advantages in comparison to traditional materials (see Section 3, Materials). Urethane based compounds such as Resilon used in AS568 style o-rings and P4700 used in urethane head seals exhibit these unique advantages including low compression set and excellent extrusion resistance.

### Urethane O-rings









Parker urethane o-rings offer the material advantages exclusive to the Resilon family of compounds in standard and custom o-ring sizes. High temperature Resilon o-rings eliminates the need for back-ups, simplifying installation and reducing damage due to spiral failure.

### Urethane Head Seals

The HS profile static head seals are ideal for replacing o-rings and back-ups in hydraulic cylinder heads. Installation can be simplified and failures due to pinching and blow-out eliminated. The characteristics offered by P4700 urethane provide the performance advantages for this profile.

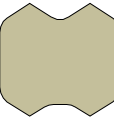
## Profiles

Table 11-1: Product Profiles

Series	Description	Application (Duty)				Page
		Light	Medium	Heavy	Pneumatic	
568 	High Performance Urethane O-rings					11-2
HS 	Static Head Seals					11-15

# Urethane O-ring 568 Profile

Catalog EPS 5370/USA

## 568 Profile, Resilon O-ring

Parker is pleased to offer the material advantages of the Resilon family of urethanes in standard o-ring sizes. The high extrusion resistance of 4300 and related compounds eliminates the need for a back-up in many hydraulic applications, thereby simplifying installation and reducing groove width. Resilon's unmatched temperature rating makes it suitable in applications where other urethanes fail. In addition, Resilon WR (4301) provides superior water resistance and compression set resistance in water-based fluids. Premium urethane o-rings are much less prone to spiral failure and installation damage compared with rubber o-rings. Dimensions and tolerances of Parker Resilon o-rings match up with AS568B specifications for diameter and cross-section and are used in the same grooves.



568 Cross Section

## Technical Data

Standard Materials*	Temperature	Pressure
P4300A90	-65°F to 275°F (-54°C to 135°C)	5,000 psi (344 bar) dynamic 10,000 psi (688 bar) static
P4301A90	-65°F to 275°F (-54°C to 135°C)	5,000 psi (344 bar) dynamic 10,000 psi (688 bar) static

**\*Alternate Materials:** For applications that may require an alternate material, please contact your local Parker Seal representative.

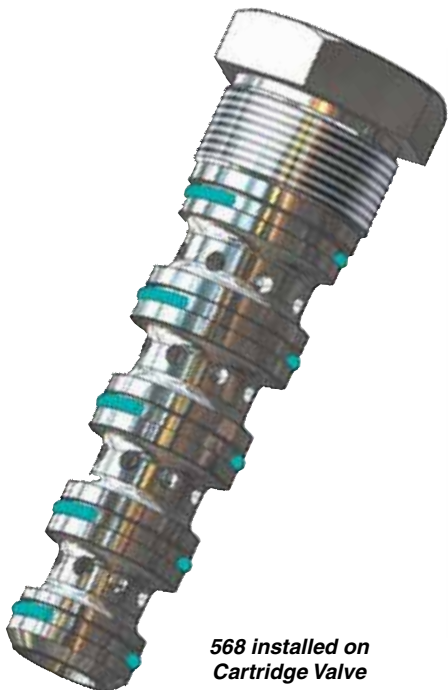

568 installed on  
Cartridge Valve

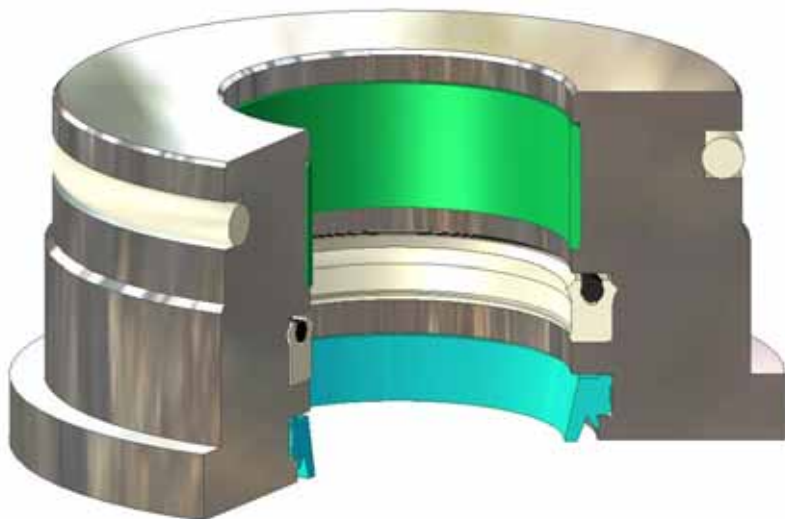

568 installed in Static Head Gland

### Part Number Nomenclature — 568 Profile

Table 11-2. 568 Profile — Inch

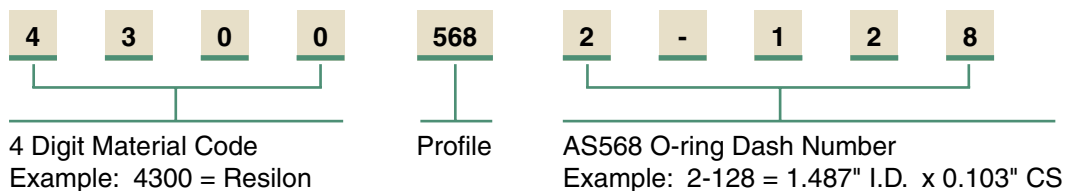

### Gland Dimensions — 568 Profile — Dynamic

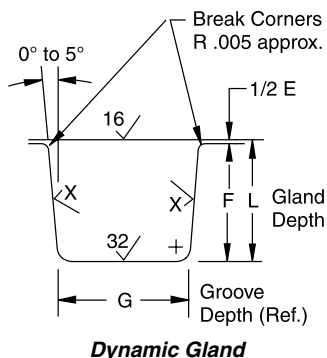
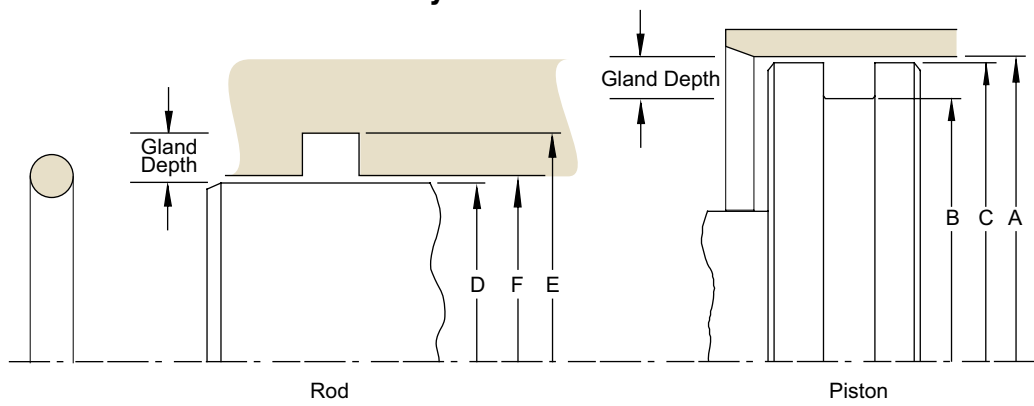

Table 11-3. General O-ring Dimensional Data

O-ring 2-Size AS568	Cross Section		Dynamic			E Diametral Clearance (a)	G-Groove Width			R Groove Radius	Max. Eccentricity (b)
	Nominal	Actual	L Gland Depth	Squeeze			0 Back-up Ring (G)	1 Back-up Ring (G)	2 Back-up Ring (G)		
				Actual	%						
004 to 050	1/16	.070 ±.003	.055 to .057	.010 to .018	15 to 25	.002 to .005	.093 to .098	.138 to .143	.205 to .210	.005 to .015	.002
102 through 178	3/32	.103 ±.003	.088 to .090	.01 to .018	10 to 17	.002 to .005	.140 to .145	.171 to .176	.238 to .243	.005 to .015	.002
201 through 284	1/8	.139 ±.004	.121 to .123	.012 to .022	9 to 16	.003 to .006	.187 to .192	.208 to .213	.275 to .280	.010 to .025	.003
309 through 395	3/16	.210 ±.005	.185 to .188	.017 to .030	8 to 14	.003 to .006	.281 to .286	.311 to .316	.410 to .415	.020 to .035	.004
425 through 475	1/4	.275 ±.006	.237 to .240	.029 to .044	11 to 16	.004 to .007	.375 to .380	.408 to .413	.538 to .543	.020 to .035	.005

(a) Clearance (extrusion gap) must be held to a minimum consistent with design requirements for temperature range variation.  
 (b) Total indicator reading between groove and adjacent bearing surface.

NOTE: For sizes larger than those shown in the table, please contact your local Parker Seal representative.

09/01/07



**Table 11-4. 568 Dynamic O-ring Gland Dimensions — Inch**

O-ring 2-Size AS568	Standard Offering	Seal Dimensions					Hardware Dimensions					
		Inside Dia- meter	±	Width	±	Mean O.D. (Ref)	Piston			Rod		
							A Bore Diameter	B Groove Diameter	C Piston Diameter	D Rod Diameter	E Groove Diameter	F Throat Diameter
							+.002/ -.000	+.000/ -.002	+.000/ -.001	+.000/ -.002	+.002/ -.000	+.001/ -.000
006	X	0.114	0.005	0.070	0.003	0.254	0.249	0.139	0.247	0.124	0.234	0.126
007	X	0.145	0.005	0.070	0.003	0.285	0.280	0.170	0.278	0.155	0.265	0.157
008	X	0.176	0.005	0.070	0.003	0.316	0.311	0.201	0.309	0.186	0.296	0.188
009	X	0.208	0.005	0.070	0.003	0.348	0.343	0.233	0.341	0.218	0.328	0.220
010	X	0.239	0.005	0.070	0.003	0.379	0.374	0.264	0.372	0.249	0.359	0.251
011	X	0.301	0.005	0.070	0.003	0.441	0.436	0.326	0.434	0.311	0.421	0.313
012	X	0.364	0.005	0.070	0.003	0.504	0.499	0.389	0.497	0.374	0.484	0.376
104	X	0.112	0.005	0.103	0.003	0.318	0.312	0.136	0.310	0.124	0.300	0.126
105		0.143	0.005	0.103	0.003	0.349	0.343	0.167	0.341	0.155	0.331	0.157
106		0.174	0.005	0.103	0.003	0.380	0.374	0.198	0.372	0.186	0.362	0.188
107		0.206	0.005	0.103	0.003	0.412	0.406	0.230	0.404	0.218	0.394	0.220
108		0.237	0.005	0.103	0.003	0.443	0.437	0.261	0.435	0.249	0.425	0.313
110	X	0.362	0.005	0.103	0.003	0.568	0.562	0.386	0.560	0.374	0.550	0.376
111	X	0.424	0.005	0.103	0.003	0.630	0.624	0.448	0.622	0.436	0.612	0.438
112	X	0.487	0.005	0.103	0.003	0.693	0.687	0.511	0.685	0.499	0.675	0.501
113	X	0.549	0.007	0.103	0.003	0.755	0.749	0.573	0.747	0.561	0.737	0.563
114	X	0.612	0.009	0.103	0.003	0.818	0.812	0.636	0.810	0.624	0.800	0.626
115	X	0.674	0.009	0.103	0.003	0.880	0.874	0.698	0.872	0.686	0.862	0.688
116	X	0.737	0.009	0.103	0.003	0.943	0.937	0.761	0.935	0.749	0.925	0.751
201		0.171	0.005	0.139	0.004	0.449	0.437	0.195	0.434	0.185	0.427	0.188
202		0.234	0.005	0.139	0.004	0.512	0.500	0.258	0.497	0.248	0.490	0.251
203		0.296	0.005	0.139	0.004	0.574	0.562	0.320	0.559	0.310	0.552	0.313
204		0.359	0.005	0.139	0.004	0.637	0.625	0.383	0.622	0.373	0.615	0.376
205		0.421	0.005	0.139	0.004	0.699	0.687	0.445	0.684	0.435	0.677	0.438
206	X	0.484	0.005	0.139	0.004	0.762	0.750	0.508	0.747	0.498	0.740	0.501
207		0.546	0.007	0.139	0.004	0.824	0.812	0.570	0.809	0.560	0.802	0.563
208	X	0.609	0.009	0.139	0.004	0.887	0.875	0.633	0.872	0.623	0.865	0.626
209	X	0.671	0.009	0.139	0.004	0.949	0.937	0.695	0.934	0.685	0.927	0.688
210	X	0.734	0.010	0.139	0.004	1.012	1.000	0.758	0.997	0.748	0.990	0.751
211	X	0.796	0.010	0.139	0.004	1.074	1.062	0.820	1.059	0.810	1.052	0.813
212	X	0.859	0.010	0.139	0.004	1.137	1.125	0.883	1.122	0.873	1.115	0.876
213	X	0.921	0.010	0.139	0.004	1.199	1.187	0.945	1.184	0.935	1.177	0.938
214	X	0.984	0.010	0.139	0.004	1.262	1.250	1.008	1.247	0.998	1.240	1.001
215		1.046	0.010	0.139	0.004	1.324	1.312	1.070	1.309	1.060	1.302	1.063
216	X	1.109	0.012	0.139	0.004	1.387	1.375	1.133	1.372	1.123	1.365	1.126
217	X	1.171	0.012	0.139	0.004	1.449	1.437	1.195	1.434	1.185	1.427	1.188
218	X	1.234	0.012	0.139	0.004	1.512	1.500	1.258	1.497	1.248	1.490	1.251
219	X	1.296	0.012	0.139	0.004	1.574	1.562	1.320	1.559	1.310	1.552	1.313

Those Piston O.D.'s shown in shaded area may over stretch the o-ring. If so, select a material with greater elongation or use a two-piece piston.



Table 11-4. 568 Dynamic O-ring Gland Dimensions — Inch (Continued)

O-ring 2-Size AS568	Standard Offering	Seal Dimensions					Hardware Dimensions					
		Inside Dia- meter	±	Width	±	Mean O.D. (Ref)	Piston			Rod		
							A Bore Diameter	B Groove Diameter	C Piston Diameter	D Rod Diameter	E Groove Diameter	F Throat Diameter
							+0.002/ -0.000	+0.000/ -0.002	+0.000/ -0.001	+0.000/ -0.002	+0.002/ -0.000	+0.001/ -0.000
220	X	1.359	0.012	0.139	0.004	1.637	1.625	1.383	1.622	1.373	1.615	1.376
221		1.421	0.012	0.139	0.004	1.699	1.687	1.445	1.684	1.435	1.677	1.438
222	X	1.484	0.015	0.139	0.004	1.762	1.750	1.508	1.747	1.498	1.740	1.501
309		0.412	0.005	0.210	0.005	0.832	0.812	0.442	0.809	0.435	0.805	0.438
310		0.475	0.005	0.210	0.005	0.895	0.875	0.505	0.872	0.498	0.868	0.501
311	X	0.537	0.007	0.210	0.005	0.957	0.937	0.567	0.934	0.560	0.930	0.563
312		0.600	0.009	0.210	0.005	1.020	1.000	0.630	0.997	0.623	0.993	0.626
313		0.662	0.009	0.210	0.005	1.082	1.062	0.692	1.059	0.685	1.055	0.688
314		0.725	0.010	0.210	0.005	1.145	1.125	0.755	1.122	0.748	1.118	0.751
315		0.787	0.010	0.210	0.005	1.207	1.187	0.817	1.184	0.810	1.180	0.813
316		0.850	0.010	0.210	0.005	1.270	1.250	0.880	1.247	0.873	1.243	0.876
317		0.912	0.010	0.210	0.005	1.332	1.312	0.942	1.309	0.935	1.305	0.938
318		0.975	0.010	0.210	0.005	1.395	1.375	1.005	1.372	0.998	1.368	1.001
319	X	1.037	0.010	0.210	0.005	1.457	1.437	1.067	1.434	1.060	1.430	1.063
320		1.100	0.012	0.210	0.005	1.520	1.500	1.130	1.497	1.123	1.493	1.126
321	X	1.162	0.012	0.210	0.005	1.582	1.562	1.192	1.559	1.185	1.555	1.188
322		1.225	0.012	0.210	0.005	1.645	1.625	1.255	1.622	1.248	1.618	1.251
323		1.287	0.012	0.210	0.005	1.707	1.687	1.317	1.684	1.310	1.680	1.313
324	X	1.350	0.012	0.210	0.005	1.770	1.750	1.380	1.747	1.373	1.743	1.376
325	X	1.475	0.015	0.210	0.005	1.895	1.875	1.505	1.872	1.498	1.868	1.501
326		1.600	0.015	0.210	0.005	2.020	2.000	1.630	1.997	1.623	1.993	1.626
327	X	1.725	0.015	0.210	0.005	2.145	2.125	1.755	2.122	1.748	2.118	1.751
328	X	1.850	0.015	0.210	0.005	2.270	2.250	1.880	2.247	1.873	2.243	1.876
329	X	1.975	0.018	0.210	0.005	2.395	2.375	2.005	2.372	1.998	2.368	2.001
330		2.100	0.018	0.210	0.005	2.520	2.500	2.130	2.497	2.123	2.493	2.126
331		2.225	0.018	0.210	0.005	2.645	2.625	2.255	2.622	2.248	2.618	2.251
332	X	2.350	0.018	0.210	0.005	2.770	2.750	2.380	2.747	2.373	2.743	2.376
333		2.475	0.020	0.210	0.005	2.895	2.875	2.505	2.872	2.498	2.868	2.501
334		2.600	0.020	0.210	0.005	3.020	3.000	2.630	2.997	2.623	2.993	2.626
335		2.725	0.020	0.210	0.005	3.145	3.125	2.755	3.122	2.748	3.118	2.751
336		2.850	0.020	0.210	0.005	3.270	3.250	2.880	3.247	2.873	3.243	2.876
337	X	2.975	0.024	0.210	0.005	3.395	3.375	3.005	3.372	2.998	3.368	3.001
338		3.100	0.024	0.210	0.005	3.520	3.500	3.130	3.497	3.123	3.493	3.126
339		3.225	0.024	0.210	0.005	3.645	3.625	3.255	3.622	3.248	3.618	3.251
340		3.350	0.024	0.210	0.005	3.770	3.750	3.380	3.747	3.373	3.743	3.376
341	X	3.475	0.024	0.210	0.005	3.895	3.875	3.505	3.872	3.498	3.868	3.501
342		3.600	0.028	0.210	0.005	4.020	4.000	3.630	3.997	3.623	3.993	3.626
343		3.725	0.028	0.210	0.005	4.145	4.125	3.755	4.122	3.748	4.118	3.751

Those Piston O.D.'s shown in shaded area may over stretch the o-ring. If so, select a material with greater elongation or use a two-piece piston.

**Table 11-4. 568 Dynamic O-ring Gland Dimensions — Inch (Continued)**

O-ring 2-Size AS568	Standard Offering	Seal Dimensions					Hardware Dimensions					
		Inside Dia- meter	±	Width	±	Mean O.D. (Ref)	Piston			Rod		
							A Bore Diameter	B Groove Diameter	C Piston Diameter	D Rod Diameter	E Groove Diameter	F Throat Diameter
							+.002/ -.000	+.000/ -.002	+.000/ -.001	+.000/ -.002	+.002/ -.000	+.001/ -.000
344		3.850	0.028	0.210	0.005	4.270	4.250	3.880	4.247	3.873	4.243	3.876
345		3.975	0.028	0.210	0.005	4.395	4.375	4.005	4.372	3.998	4.368	4.001
346		4.100	0.028	0.210	0.005	4.520	4.500	4.130	4.497	4.123	4.493	4.126
347		4.225	0.030	0.210	0.005	4.645	4.625	4.255	4.622	4.248	4.618	4.251
348	X	4.350	0.030	0.210	0.005	4.770	4.750	4.380	4.747	4.373	4.743	4.376
349		4.475	0.030	0.210	0.005	4.895	4.875	4.505	4.872	4.498	4.868	4.501
425		4.475	0.033	0.275	0.006	5.025	5.002	4.528	4.998	4.497	4.971	4.501
426		4.600	0.033	0.275	0.006	5.150	5.127	4.653	5.123	4.622	5.096	4.626
427		4.725	0.033	0.275	0.006	5.275	5.252	4.778	5.248	4.747	5.221	4.751
428		4.850	0.033	0.275	0.006	5.400	5.377	4.903	5.373	4.872	5.346	4.876
429		4.975	0.037	0.275	0.006	5.525	5.502	5.028	5.498	4.997	5.471	5.001
430		5.100	0.037	0.275	0.006	5.650	5.627	5.153	5.623	5.122	5.596	5.126
431		5.225	0.037	0.275	0.006	5.775	5.752	5.278	5.748	5.247	5.721	5.251
432	X	5.350	0.037	0.275	0.006	5.900	5.877	5.403	5.873	5.372	5.846	5.376
433		5.475	0.037	0.275	0.006	6.025	6.002	5.528	5.998	5.497	5.971	5.501
434		5.600	0.037	0.275	0.006	6.150	6.127	5.653	6.123	5.622	6.096	5.626
435		5.725	0.037	0.275	0.006	6.275	6.252	5.778	6.248	5.747	6.221	5.751
436		5.850	0.037	0.275	0.006	6.400	6.377	5.903	6.373	5.872	6.346	5.876
437		5.975	0.037	0.275	0.006	6.525	6.502	6.028	6.498	5.997	6.471	6.001
438		6.225	0.040	0.275	0.006	6.775	6.752	6.278	6.748	6.247	6.721	6.251
439		6.475	0.040	0.275	0.006	7.025	7.002	6.528	6.998	6.497	6.971	6.501
440		6.725	0.040	0.275	0.006	7.275	7.252	6.778	7.248	6.747	7.221	6.751
441		6.975	0.040	0.275	0.006	7.525	7.502	7.028	7.498	6.997	7.471	7.001
442		7.225	0.045	0.275	0.006	7.775	7.752	7.278	7.748	7.247	7.721	7.251
443		7.475	0.045	0.275	0.006	8.025	8.002	7.528	7.998	7.497	7.971	7.501
444		7.725	0.045	0.275	0.006	8.275	8.252	7.778	8.248	7.747	8.221	7.751
445		7.975	0.045	0.275	0.006	8.525	8.502	8.028	8.498	7.997	8.471	8.001
446		8.475	0.055	0.275	0.006	9.025	9.002	8.528	8.998	8.497	8.971	8.501
447		8.975	0.055	0.275	0.006	9.525	9.502	9.028	9.498	8.997	9.471	9.001
448		9.475	0.055	0.275	0.006	10.025	10.002	9.528	9.998	9.497	9.971	9.501
449		9.975	0.055	0.275	0.006	10.525	10.502	10.028	10.498	9.997	10.471	10.001
450		10.475	0.060	0.275	0.006	11.025	11.002	10.528	10.998	10.497	10.971	10.501
451		10.975	0.060	0.275	0.006	11.525	11.502	11.028	11.498	10.997	11.471	11.001
452		11.475	0.060	0.275	0.006	12.025	12.002	11.528	11.998	11.497	11.971	11.501
453		11.975	0.060	0.275	0.006	12.525	12.502	12.028	12.498	11.997	12.471	12.001
454		12.475	0.060	0.275	0.006	13.025	13.002	12.528	12.998	12.497	12.971	12.501
455		12.975	0.060	0.275	0.006	13.525	13.502	13.028	13.498	12.997	13.471	13.001
456		13.475	0.070	0.275	0.006	14.025	14.002	13.528	13.998	13.497	13.971	13.501

Those Piston O.D.'s shown in shaded area may over stretch the o-ring. If so, select a material with greater elongation or use a two-piece piston.

**Table 11-4. 568 Dynamic O-ring Gland Dimensions — Inch (Continued)**

O-ring 2-Size AS568	Standard Offering	Seal Dimensions					Hardware Dimensions					
		Inside Dia-meter	±	Width	±	Mean O.D. (Ref)	Piston			Rod		
							A Bore Diameter	B Groove Diameter	C Piston Diameter	D Rod Diameter	E Groove Diameter	F Throat Diameter
							+0.002/ -0.000	+0.000/ -0.002	+0.000/ -0.001	+0.000/ -0.002	+0.002/ -0.000	+0.001/ -0.000
457		13.975	0.070	0.275	0.006	14.525	14.502	14.028	14.498	13.997	14.471	14.001
458		14.475	0.070	0.275	0.006	15.025	15.002	14.528	14.998	14.497	14.971	14.501
459		14.975	0.070	0.275	0.006	15.525	15.502	15.028	15.498	14.997	15.471	15.001
460		15.475	0.070	0.275	0.006	16.025	16.002	15.528	15.998	15.497	15.971	15.501

Those Piston O.D.'s shown in shaded area may over stretch the o-ring. If so, select a material with greater elongation or use a two-piece piston.

NOTE: For sizes larger than those shown in the table, please contact your local Parker Seal representative.

**Gland Dimensions — 568 Profile — Static**

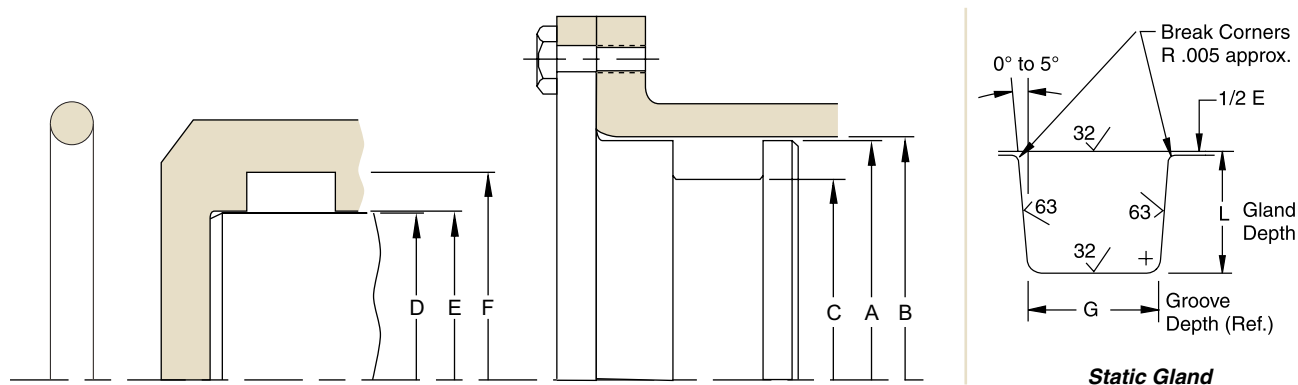

Please refer to Engineering Section 2, page 2-8 for surface finish and additional hardware considerations.

**Table 11-5. General O-ring Dimensional Data**

O-ring 2-Size AS568	Cross Section		Static			E Diametral Clearance (a)	G-Groove Width			R Groove Radius	Max. Eccentricity (b)
	Nominal	Actual	L Gland Depth	Squeeze			0 Back-up Ring (G)	1 Back-up Ring (G)	2 Back-up Ring (G)		
				Actual	%						
004 to 050	1/16	0.070 ±0.003	0.050 to 0.052	0.015 to 0.023	22 to 32	0.002 to 0.005	0.093 to 0.098	0.138 to 0.143	0.205 to 0.210	0.005 to 0.015	0.002
102 through 178	3/32	.103 ±0.003	0.081 to 0.083	0.017 to 0.025	17 to 24	0.002 to 0.005	0.140 to 0.145	0.171 to 0.176	0.238 to 0.243	0.005 to 0.015	0.002
201 through 284	1/8	.139 ±0.004	0.111 to 0.113	0.022 to 0.032	16 to 23	0.003 to 0.006	0.187 to 0.192	0.208 to 0.213	0.275 to 0.280	0.010 to 0.025	0.003
309 through 395	3/16	.210 ±0.005	0.170 to 0.173	0.032 to 0.045	15 to 21	0.003 to 0.006	0.281 to 0.286	0.311 to 0.316	0.410 to 0.415	0.020 to 0.035	0.004
425 through 475	1/4	.275 ±0.006	0.226 to 0.229	0.040 to 0.055	15 to 20	0.004 to 0.007	0.375 to 0.380	0.408 to 0.413	0.538 to 0.543	0.020 to 0.035	0.005

(a) Clearance (extrusion gap) must be held to a minimum consistent with design requirements for temperature range variation.

(b) Total indicator reading between groove and adjacent bearing surface.

NOTE: For sizes larger than those shown in the table, please contact your local Parker Seal representative.

**Table 11-6. 568 Static O-ring Gland Dimensions — Inch**

O-ring 2-Size AS568	X*	Seal Dimensions					Piston			Rod		
		Inside Diameter	±	Width	±	Mean O.D. (Ref)	A	B	C	D	E	F
							Piston Diameter	Bore Diameter	Groove Diameter	Rod Diameter	Throat Diameter	Groove Diameter
							+ .000/- .001	+ .002/- .000	+ .000/- .002	+ .000/- .002	+ .001/- .000	+ .002/- .000
001		0.029	0.004	0.040	0.003	0.109	0.103	0.105	0.044	0.040	0.042	0.101
002		0.042	0.004	0.050	0.003	0.142	0.136	0.138	0.059	0.053	0.055	0.132
003		0.056	0.004	0.060	0.003	0.176	0.170	0.173	0.077	0.067	0.069	0.162
004		0.070	0.005	0.070	0.003	0.210	0.204	0.206	0.106	0.081	0.083	0.181
005	X	0.101	0.005	0.070	0.003	0.241	0.235	0.237	0.137	0.112	0.114	0.212
006	X	0.114	0.005	0.070	0.003	0.254	0.248	0.250	0.150	0.125	0.127	0.225
007	X	0.145	0.005	0.070	0.003	0.285	0.279	0.281	0.181	0.156	0.158	0.256
008	X	0.176	0.005	0.070	0.003	0.316	0.310	0.312	0.212	0.187	0.189	0.287
009	X	0.208	0.005	0.070	0.003	0.348	0.341	0.343	0.243	0.218	0.220	0.318
010	X	0.239	0.005	0.070	0.003	0.379	0.373	0.375	0.275	0.250	0.252	0.350
011	X	0.301	0.005	0.070	0.003	0.441	0.435	0.437	0.337	0.312	0.314	0.412
012	X	0.364	0.005	0.070	0.003	0.504	0.498	0.500	0.400	0.375	0.377	0.475
013	X	0.426	0.005	0.070	0.003	0.566	0.560	0.562	0.462	0.437	0.439	0.537
014	X	0.489	0.005	0.070	0.003	0.629	0.623	0.625	0.525	0.500	0.502	0.600
015	X	0.551	0.007	0.070	0.003	0.691	0.685	0.687	0.587	0.562	0.564	0.662
016	X	0.614	0.009	0.070	0.003	0.754	0.748	0.750	0.650	0.625	0.627	0.725
017	X	0.676	0.009	0.070	0.003	0.816	0.810	0.812	0.712	0.687	0.689	0.787
018	X	0.739	0.009	0.070	0.003	0.879	0.873	0.875	0.775	0.750	0.752	0.850
019	X	0.801	0.009	0.070	0.003	0.941	0.935	0.937	0.837	0.812	0.814	0.912
020	X	0.864	0.009	0.070	0.003	1.004	0.998	1.000	0.900	0.875	0.877	0.975
021	X	0.926	0.009	0.070	0.003	1.066	1.060	1.062	0.962	0.937	0.939	1.037
022	X	0.989	0.010	0.070	0.003	1.129	1.123	1.125	1.025	1.000	1.002	1.100
023	X	1.051	0.010	0.070	0.003	1.191	1.185	1.187	1.087	1.062	1.064	1.162
024	X	1.114	0.010	0.070	0.003	1.254	1.248	1.250	1.150	1.125	1.127	1.225
025		1.176	0.011	0.070	0.003	1.316	1.310	1.312	1.212	1.187	1.189	1.287
026	X	1.239	0.011	0.070	0.003	1.379	1.373	1.375	1.275	1.250	1.252	1.350
027	X	1.301	0.011	0.070	0.003	1.441	1.435	1.437	1.337	1.312	1.314	1.412
028	X	1.364	0.013	0.070	0.003	1.504	1.498	1.500	1.400	1.375	1.377	1.475
029	X	1.489	0.013	0.070	0.003	1.629	1.623	1.625	1.525	1.500	1.502	1.600
030	X	1.614	0.013	0.070	0.003	1.754	1.748	1.750	1.650	1.625	1.627	1.725
031		1.739	0.015	0.070	0.003	1.879	1.873	1.875	1.775	1.750	1.752	1.850
032		1.864	0.015	0.070	0.003	2.004	1.998	2.000	1.900	1.875	1.877	1.975
033		1.989	0.018	0.070	0.003	2.129	2.123	2.125	2.025	2.000	2.002	2.100
034		2.114	0.018	0.070	0.003	2.254	2.248	2.250	2.150	2.125	2.127	2.225
035		2.239	0.018	0.070	0.003	2.379	2.373	2.375	2.275	2.250	2.252	2.350
036		2.364	0.018	0.070	0.003	2.504	2.498	2.500	2.400	2.375	2.377	2.475
037	X	2.489	0.018	0.070	0.003	2.629	2.623	2.625	2.525	2.500	2.502	2.600

\*X = Standard Offering.

Those Piston O.D.'s shown in shaded area may over stretch the o-ring. If so, select a material with greater elongation or use a two-piece piston.

Table 11-6. 568 Static O-ring Gland Dimensions — Inch (Continued)

O-ring 2-Size AS568	X*	Seal Dimensions					Piston			Rod		
		Inside Diameter	±	Width	±	Mean O.D. (Ref)	A	B	C	D	E	F
							Piston Diameter	Bore Diameter	Groove Diameter	Rod Diameter	Throat Diameter	Groove Diameter
							+0.000/-0.001	+0.002/-0.000	+0.000/-0.002	+0.000/-0.002	+0.001/-0.000	+0.002/-0.000
038		2.614	0.020	0.070	0.003	2.754	2.748	2.750	2.650	2.625	2.627	2.725
039		2.739	0.020	0.070	0.003	2.879	2.873	2.875	2.775	2.750	2.752	2.850
040		2.864	0.020	0.070	0.003	3.004	2.998	3.000	2.900	2.875	2.877	2.975
041		2.989	0.024	0.070	0.003	3.129	3.123	3.125	3.025	3.000	3.002	3.100
042		3.239	0.024	0.070	0.003	3.379	3.373	3.375	3.275	3.250	3.252	3.350
043		3.489	0.024	0.070	0.003	3.629	3.623	3.625	3.525	3.500	3.502	3.600
044		3.739	0.027	0.070	0.003	3.879	3.873	3.875	3.775	3.750	3.752	3.850
045		3.989	0.027	0.070	0.003	4.129	4.123	4.125	4.025	4.000	4.002	4.100
046		4.239	0.030	0.070	0.003	4.379	4.373	4.375	4.275	4.250	4.252	4.350
047		4.489	0.030	0.070	0.003	4.629	4.623	4.625	4.525	4.500	4.502	4.600
048		4.739	0.030	0.070	0.003	4.879	4.873	4.875	4.775	4.750	4.752	4.850
049		4.989	0.037	0.070	0.003	5.129	5.123	5.125	5.025	5.000	5.002	5.100
050		5.239	0.037	0.070	0.003	5.379	5.373	5.375	5.275	5.250	5.252	5.350
102		0.049	0.005	0.103	0.003	0.255	0.245	0.247	0.085	0.062	0.064	0.224
103		0.081	0.005	0.103	0.003	0.287	0.276	0.278	0.116	0.094	0.095	0.256
104		0.112	0.005	0.103	0.003	0.318	0.308	0.310	0.148	0.125	0.127	0.287
105		0.143	0.005	0.103	0.003	0.349	0.340	0.342	0.180	0.156	0.158	0.318
106		0.174	0.005	0.103	0.003	0.380	0.372	0.374	0.212	0.187	0.189	0.349
107		0.206	0.005	0.103	0.003	0.412	0.403	0.405	0.243	0.219	0.221	0.381
108		0.237	0.005	0.103	0.003	0.443	0.435	0.437	0.275	0.250	0.252	0.412
109	X	0.299	0.005	0.103	0.003	0.505	0.498	0.500	0.338	0.312	0.314	0.474
110	X	0.362	0.005	0.103	0.003	0.568	0.560	0.562	0.400	0.375	0.377	0.537
111	X	0.424	0.005	0.103	0.003	0.630	0.623	0.625	0.463	0.437	0.439	0.599
112	X	0.487	0.005	0.103	0.003	0.693	0.685	0.687	0.525	0.500	0.502	0.662
113	X	0.549	0.007	0.103	0.003	0.755	0.748	0.750	0.588	0.562	0.564	0.724
114	X	0.612	0.009	0.103	0.003	0.818	0.810	0.812	0.650	0.625	0.627	0.787
115	X	0.674	0.009	0.103	0.003	0.880	0.873	0.875	0.713	0.687	0.689	0.849
116	X	0.737	0.009	0.103	0.003	0.943	0.935	0.937	0.775	0.750	0.752	0.912
117	X	0.799	0.010	0.103	0.003	1.005	0.998	1.000	0.838	0.812	0.814	0.974
118	X	0.862	0.010	0.103	0.003	1.068	1.060	1.062	0.900	0.875	0.877	1.037
119	X	0.924	0.010	0.103	0.003	1.130	1.123	1.125	0.963	0.937	0.939	1.099
120	X	0.987	0.010	0.103	0.003	1.193	1.185	1.187	1.025	1.000	1.002	1.162
121	X	1.049	0.010	0.103	0.003	1.255	1.248	1.250	1.088	1.062	1.064	1.224
122	X	1.112	0.010	0.103	0.003	1.318	1.310	1.312	1.150	1.125	1.127	1.287
123	X	1.174	0.012	0.103	0.003	1.380	1.373	1.375	1.213	1.187	1.189	1.349
124	X	1.237	0.012	0.103	0.003	1.443	1.435	1.437	1.275	1.250	1.252	1.412
125	X	1.299	0.012	0.103	0.003	1.505	1.498	1.500	1.338	1.312	1.314	1.474

\*X = Standard Offering.

Those Piston O.D.'s shown in shaded area may over stretch the o-ring. If so, select a material with greater elongation or use a two-piece piston.

Table 11-6. 568 Static O-ring Gland Dimensions — Inch (Continued)

O-ring 2-Size AS568	X*	Seal Dimensions					Piston			Rod		
		Inside Diameter	±	Width	±	Mean O.D. (Ref)	A	B	C	D	E	F
							Piston Diameter	Bore Diameter	Groove Diameter	Rod Diameter	Throat Diameter	Groove Diameter
							+0.000/-0.001	+0.002/-0.000	+0.000/-0.002	+0.000/-0.002	+0.001/-0.000	+0.002/-0.000
126	X	1.362	0.012	0.103	0.003	1.568	1.560	1.562	1.400	1.375	1.377	1.537
127	X	1.424	0.012	0.103	0.003	1.630	1.623	1.625	1.463	1.437	1.439	1.599
128	X	1.487	0.012	0.103	0.003	1.693	1.685	1.687	1.525	1.500	1.502	1.662
129	X	1.549	0.015	0.103	0.003	1.755	1.748	1.750	1.588	1.562	1.564	1.724
130	X	1.612	0.015	0.103	0.003	1.818	1.810	1.812	1.650	1.625	1.627	1.787
131	X	1.674	0.015	0.103	0.003	1.880	1.873	1.875	1.713	1.687	1.689	1.849
132		1.737	0.015	0.103	0.003	1.943	1.935	1.937	1.775	1.750	1.752	1.912
133	X	1.799	0.015	0.103	0.003	2.005	1.998	2.000	1.838	1.812	1.814	1.974
134	X	1.862	0.015	0.103	0.003	2.068	2.060	2.062	1.900	1.875	1.877	2.037
135	X	1.925	0.017	0.103	0.003	2.131	2.123	2.125	1.963	1.997	1.939	2.099
136	X	1.987	0.017	0.103	0.003	2.193	2.185	2.187	2.025	2.000	2.002	2.162
137		2.050	0.017	0.103	0.003	2.256	2.248	2.250	2.088	2.062	2.064	2.224
138		2.112	0.017	0.103	0.003	2.318	2.310	2.312	2.150	2.125	2.127	2.287
139		2.175	0.017	0.103	0.003	2.381	2.373	2.375	2.213	2.187	2.189	2.349
140		2.237	0.017	0.103	0.003	2.443	2.435	2.437	2.275	2.250	2.252	2.412
141		2.300	0.020	0.103	0.003	2.506	2.498	2.500	2.338	2.312	2.315	2.474
142	X	2.362	0.020	0.103	0.003	2.568	2.560	2.562	2.400	2.375	2.377	2.537
143	X	2.425	0.020	0.103	0.003	2.631	2.623	2.625	2.463	2.437	2.439	2.599
144	X	2.487	0.020	0.103	0.003	2.693	2.685	2.687	2.525	2.500	2.502	2.662
145		2.550	0.020	0.103	0.003	2.756	2.748	2.750	2.588	2.562	2.564	2.724
146		2.612	0.020	0.103	0.003	2.818	2.810	2.812	2.650	2.625	2.627	2.787
147		2.675	0.022	0.103	0.003	2.881	2.873	2.875	2.713	2.687	2.689	2.849
148		2.737	0.022	0.103	0.003	2.943	2.935	2.937	2.775	2.750	2.752	2.912
149		2.800	0.022	0.103	0.003	3.006	2.998	3.000	2.838	2.812	2.814	2.974
150		2.862	0.022	0.103	0.003	3.068	3.060	3.062	2.900	2.875	2.877	3.037
151		2.987	0.024	0.103	0.003	3.193	3.185	3.187	3.025	3.000	3.002	3.162
152		3.237	0.024	0.103	0.003	3.443	3.435	3.437	3.275	3.250	3.252	3.412
153		3.487	0.024	0.103	0.003	3.693	3.685	3.687	3.525	3.500	3.502	3.662
154		3.737	0.028	0.103	0.003	3.943	3.935	3.937	3.775	3.750	3.752	3.912
155	X	3.987	0.028	0.103	0.003	4.193	4.185	4.187	4.025	4.000	4.002	4.162
156	X	4.237	0.030	0.103	0.003	4.443	4.435	4.437	4.275	4.250	4.252	4.412
157		4.487	0.030	0.103	0.003	4.693	4.685	4.687	4.525	4.500	4.502	4.662
158		4.737	0.030	0.103	0.003	4.943	4.935	4.937	4.775	4.750	4.752	4.912
159		4.987	0.035	0.103	0.003	5.193	5.185	5.187	5.025	5.000	5.002	5.162
160		5.237	0.035	0.103	0.003	5.443	5.435	5.437	5.275	5.250	5.252	5.412
161		5.487	0.035	0.103	0.003	5.693	5.685	5.687	5.525	5.500	5.502	5.662
162		5.737	0.035	0.103	0.003	5.943	5.935	5.937	5.775	5.750	5.752	5.912

\*X = Standard Offering.

Those Piston O.D.'s shown in shaded area may over stretch the o-ring. If so, select a material with greater elongation or use a two-piece piston.

Table 11-6. 568 Static O-ring Gland Dimensions — Inch (Continued)

O-ring 2-Size AS568	X*	Seal Dimensions					Piston			Rod		
		Inside Diameter	±	Width	±	Mean O.D. (Ref)	A	B	C	D	E	F
							Piston Diameter	Bore Diameter	Groove Diameter	Rod Diameter	Throat Diameter	Groove Diameter
							+0.000/-0.001	+0.002/-0.000	+0.000/-0.002	+0.000/-0.002	+0.001/-0.000	+0.002/-0.000
163		5.987	0.035	0.103	0.003	6.193	6.185	6.187	6.025	6.000	6.002	6.162
164		6.237	0.040	0.103	0.003	6.443	6.435	6.437	6.275	6.250	6.252	6.412
165		6.487	0.040	0.103	0.003	6.693	6.685	6.687	6.525	6.500	6.502	6.662
166		6.737	0.040	0.103	0.003	6.943	6.935	6.937	6.775	6.750	6.752	6.912
167		6.987	0.040	0.103	0.003	7.193	7.185	7.187	7.025	7.000	7.002	7.162
201		0.171	0.005	0.139	0.004	0.449	0.434	0.437	0.215	0.187	0.190	0.409
202		0.234	0.005	0.139	0.004	0.512	0.497	0.500	0.278	0.250	0.253	0.472
203		0.296	0.005	0.139	0.004	0.574	0.559	0.562	0.340	0.312	0.315	0.534
204		0.359	0.005	0.139	0.004	0.637	0.622	0.625	0.403	0.375	0.378	0.597
205		0.421	0.005	0.139	0.004	0.699	0.684	0.687	0.465	0.437	0.440	0.659
206	X	0.484	0.005	0.139	0.004	0.762	0.747	0.750	0.528	0.500	0.503	0.722
207		0.546	0.007	0.139	0.004	0.824	0.809	0.812	0.590	0.562	0.565	0.784
208	X	0.609	0.009	0.139	0.004	0.887	0.872	0.875	0.653	0.625	0.628	0.847
209	X	0.671	0.009	0.139	0.004	0.949	0.934	0.937	0.715	0.687	0.690	0.909
210	X	0.734	0.010	0.139	0.004	1.012	0.997	1.000	0.778	0.750	0.753	0.972
211	X	0.796	0.010	0.139	0.004	1.074	1.059	1.062	0.840	0.812	0.815	1.034
212	X	0.859	0.010	0.139	0.004	1.137	1.122	1.125	0.903	0.875	0.878	1.097
213	X	0.921	0.010	0.139	0.004	1.199	1.184	1.187	0.965	0.937	0.940	1.159
214	X	0.984	0.010	0.139	0.004	1.262	1.247	1.250	1.028	1.000	1.003	1.222
215		1.046	0.010	0.139	0.004	1.324	1.309	1.312	1.090	1.062	1.065	1.284
216	X	1.109	0.012	0.139	0.004	1.387	1.372	1.375	1.153	1.125	1.128	1.347
217	X	1.171	0.012	0.139	0.004	1.449	1.434	1.437	1.215	1.187	1.190	1.409
218	X	1.234	0.012	0.139	0.004	1.512	1.497	1.500	1.278	1.250	1.253	1.472
219	X	1.296	0.012	0.139	0.004	1.574	1.559	1.562	1.340	1.312	1.315	1.534
220	X	1.359	0.012	0.139	0.004	1.637	1.622	1.625	1.403	1.375	1.378	1.597
221		1.421	0.012	0.139	0.004	1.699	1.684	1.687	1.465	1.437	1.440	1.659
222	X	1.484	0.015	0.139	0.004	1.762	1.747	1.750	1.528	1.500	1.503	1.722
223	X	1.609	0.015	0.139	0.004	1.887	1.872	1.875	1.653	1.625	1.628	1.847
224	X	1.734	0.015	0.139	0.004	2.012	1.997	2.000	1.778	1.750	1.753	1.972
225	X	1.859	0.015	0.139	0.004	2.137	2.122	2.125	1.903	1.875	1.878	2.097
226		1.984	0.018	0.139	0.004	2.262	2.247	2.250	2.028	2.000	2.003	2.222
227		2.109	0.018	0.139	0.004	2.387	2.372	2.375	2.153	2.125	2.128	2.347
228	X	2.234	0.020	0.139	0.004	2.512	2.497	2.500	2.278	2.250	2.253	2.472
229		2.359	0.020	0.139	0.004	2.637	2.622	2.625	2.403	2.375	2.378	2.597
230		2.484	0.020	0.139	0.004	2.762	2.747	2.750	2.528	2.500	2.503	2.722
231	X	2.609	0.020	0.139	0.004	2.887	2.872	2.875	2.653	2.625	2.628	2.847
232	X	2.734	0.024	0.139	0.004	3.012	2.997	3.000	2.778	2.750	2.753	2.972

\*X = Standard Offering.

Those Piston O.D.'s shown in shaded area may over stretch the o-ring. If so, select a material with greater elongation or use a two-piece piston.



Table 11-6. 568 Static O-ring Gland Dimensions — Inch (Continued)

O-ring 2-Size AS568	X*	Seal Dimensions					Piston			Rod		
		Inside Diameter	±	Width	±	Mean O.D. (Ref)	A	B	C	D	E	F
							Piston Diameter	Bore Diameter	Groove Diameter	Rod Diameter	Throat Diameter	Groove Diameter
							+0.000/-0.001	+0.002/-0.000	+0.000/-0.002	+0.000/-0.002	+0.001/-0.000	+0.002/-0.000
233	X	2.859	0.024	0.139	0.004	3.137	3.122	3.125	2.903	2.875	2.878	3.097
234	X	2.984	0.024	0.139	0.004	3.262	3.247	3.250	3.028	3.000	3.003	3.222
235	X	3.109	0.024	0.139	0.004	3.387	3.372	3.375	3.153	3.125	3.128	3.347
236	X	3.234	0.024	0.139	0.004	3.512	3.497	3.500	3.278	3.250	3.253	3.472
237	X	3.359	0.024	0.139	0.004	3.637	3.622	3.625	3.403	3.375	3.378	3.597
238		3.484	0.024	0.139	0.004	3.762	3.747	3.750	3.528	3.500	3.503	3.722
239		3.609	0.028	0.139	0.004	3.887	3.872	3.875	3.653	3.625	3.628	3.847
240	X	3.734	0.028	0.139	0.004	4.012	3.997	4.000	3.778	3.750	3.753	3.972
241		3.859	0.028	0.139	0.004	4.137	4.122	4.125	3.903	3.875	3.878	4.097
242	X	3.984	0.028	0.139	0.004	4.262	4.247	4.250	4.028	4.000	4.003	4.222
243		4.109	0.028	0.139	0.004	4.387	4.372	4.375	4.153	4.125	4.128	4.347
244		4.234	0.030	0.139	0.004	4.512	4.497	4.500	4.278	4.250	4.253	4.472
245		4.359	0.030	0.139	0.004	4.637	4.622	4.625	4.403	4.375	4.378	4.597
246		4.484	0.030	0.139	0.004	4.762	4.747	4.750	4.528	4.500	4.503	4.722
247		4.609	0.030	0.139	0.004	4.887	4.872	4.875	4.653	4.625	4.628	4.847
248		4.734	0.030	0.139	0.004	5.012	4.997	5.000	4.778	4.750	4.753	4.972
							+0.000/-0.001	+0.002/-0.000	+0.000/-0.004	+0.000/-0.002	+0.001/-0.000	+0.004/-0.000
249		4.859	0.035	0.139	0.004	5.137	5.122	5.125	4.903	4.875	4.878	5.097
250		4.984	0.035	0.139	0.004	5.262	5.247	5.250	5.028	5.000	5.003	5.222
251		5.109	0.035	0.139	0.004	5.387	5.372	5.375	5.153	5.125	5.128	5.347
252		5.234	0.035	0.139	0.004	5.512	5.497	5.500	5.278	5.250	5.253	5.472
253		5.359	0.035	0.139	0.004	5.637	5.622	5.625	5.403	5.375	5.378	5.597
254		5.484	0.035	0.139	0.004	5.762	5.747	5.750	5.528	5.500	5.503	5.722
255		5.609	0.035	0.139	0.004	5.887	5.872	5.875	5.653	5.625	5.628	5.847
256		5.734	0.035	0.139	0.004	6.012	5.997	6.000	5.778	5.750	5.753	5.972
257		5.859	0.035	0.139	0.004	6.137	6.122	6.125	5.903	5.875	5.878	6.097
258		5.984	0.035	0.139	0.004	6.262	6.247	6.250	6.028	6.000	6.003	6.222
259		6.234	0.040	0.139	0.004	6.512	6.497	6.500	6.278	6.250	6.253	6.472
260		6.484	0.040	0.139	0.004	6.762	6.747	6.750	6.528	6.500	6.503	6.722
261		6.734	0.040	0.139	0.004	7.012	6.997	7.000	6.778	6.750	6.753	6.972
262		6.984	0.040	0.139	0.004	7.262	7.247	7.250	7.028	7.000	7.003	7.222
309		0.412	0.005	0.210	0.005	0.832	0.809	0.812	0.472	0.437	0.440	0.777
310		0.475	0.005	0.210	0.005	0.895	0.872	0.875	0.535	0.500	0.503	0.840
311	X	0.537	0.007	0.210	0.005	0.957	0.934	0.937	0.597	0.562	0.565	0.902
312		0.600	0.009	0.210	0.005	1.020	0.997	1.000	0.660	0.625	0.628	0.965
313		0.662	0.009	0.210	0.005	1.082	1.059	1.062	0.722	0.687	0.690	1.027
314		0.725	0.010	0.210	0.005	1.145	1.122	1.125	0.785	0.750	0.753	1.090

\*X = Standard Offering.

Those Piston O.D.'s shown in shaded area may over stretch the o-ring. If so, select a material with greater elongation or use a two-piece piston.

Table 11-6. 568 Static O-ring Gland Dimensions — Inch (Continued)

O-ring 2-Size AS568	X*	Seal Dimensions					Piston			Rod		
		Inside Diameter	±	Width	±	Mean O.D. (Ref)	A	B	C	D	E	F
							Piston Diameter	Bore Diameter	Groove Diameter	Rod Diameter	Throat Diameter	Groove Diameter
							+0.000/-0.001	+0.002/-0.000	+0.000/-0.004	+0.000/-0.002	+0.001/-0.000	+0.004/-0.000
315		0.787	0.010	0.210	0.005	1.207	1.184	1.187	0.847	0.812	0.815	1.152
316		0.850	0.010	0.210	0.005	1.270	1.247	1.250	0.910	0.875	0.878	1.215
317		0.912	0.010	0.210	0.005	1.332	1.309	1.312	0.972	0.937	0.940	1.277
318		0.975	0.010	0.210	0.005	1.395	1.372	1.375	1.035	1.000	1.003	1.340
319	X	1.037	0.010	0.210	0.005	1.457	1.434	1.437	1.097	1.062	1.065	1.402
320		1.100	0.012	0.210	0.005	1.520	1.497	1.500	1.160	1.125	1.128	1.465
321	X	1.162	0.012	0.210	0.005	1.582	1.559	1.562	1.222	1.187	1.190	1.527
322		1.225	0.012	0.210	0.005	1.645	1.622	1.625	1.285	1.250	1.253	1.590
323		1.287	0.012	0.210	0.005	1.707	1.684	1.687	1.347	1.312	1.315	1.652
324	X	1.350	0.012	0.210	0.005	1.770	1.747	1.750	1.410	1.375	1.378	1.715
325	X	1.475	0.015	0.210	0.005	1.895	1.872	1.875	1.535	1.500	1.503	1.840
326		1.600	0.015	0.210	0.005	2.020	1.997	2.000	1.660	1.625	1.628	1.965
327	X	1.725	0.015	0.210	0.005	2.145	2.122	2.125	1.785	1.750	1.753	2.090
328	X	1.850	0.015	0.210	0.005	2.270	2.247	2.250	1.910	1.875	1.878	2.215
329	X	1.975	0.018	0.210	0.005	2.395	2.372	2.375	2.035	2.000	2.003	2.340
330		2.100	0.018	0.210	0.005	2.520	2.497	2.500	2.160	2.125	2.128	2.465
331		2.225	0.018	0.210	0.005	2.645	2.622	2.625	2.285	2.250	2.253	2.590
332	X	2.350	0.018	0.210	0.005	2.770	2.747	2.750	2.410	2.375	2.378	2.715
333		2.475	0.020	0.210	0.005	2.895	2.872	2.875	2.535	2.500	2.503	2.840
334		2.600	0.020	0.210	0.005	3.020	2.997	3.000	2.660	2.625	2.628	2.965
335		2.725	0.020	0.210	0.005	3.145	3.122	3.125	2.785	2.750	2.753	3.090
336		2.850	0.020	0.210	0.005	3.270	3.247	3.250	2.910	2.875	2.878	3.215
337	X	2.975	0.024	0.210	0.005	3.395	3.372	3.375	3.035	3.000	3.003	3.340
338		3.100	0.024	0.210	0.005	3.520	3.497	3.500	3.160	3.125	3.128	3.465
339		3.225	0.024	0.210	0.005	3.645	3.622	3.625	3.285	3.250	3.253	3.590
340		3.350	0.024	0.210	0.005	3.770	3.747	3.750	3.410	3.375	3.378	3.715
341	X	3.475	0.024	0.210	0.005	3.895	3.872	3.875	3.535	3.500	3.503	3.840
342		3.600	0.028	0.210	0.005	4.020	3.997	4.000	3.660	3.625	3.628	3.965
343		3.725	0.028	0.210	0.005	4.145	4.122	4.125	3.785	3.750	3.753	4.090
344		3.850	0.028	0.210	0.005	4.270	4.247	4.250	3.910	3.875	3.878	4.215
345		3.975	0.028	0.210	0.005	4.395	4.372	4.375	4.035	4.000	4.003	4.340
346		4.100	0.028	0.210	0.005	4.520	4.497	4.500	4.160	4.125	4.128	4.465
347		4.225	0.030	0.210	0.005	4.645	4.622	4.625	4.285	4.250	4.253	4.590
348	X	4.350	0.030	0.210	0.005	4.773	4.747	4.750	4.410	4.375	4.378	4.717
349		4.475	0.030	0.210	0.005	4.895	4.872	4.875	4.535	4.500	4.503	4.840
350		4.600	0.030	0.210	0.005	5.020	4.997	5.000	4.660	4.625	4.628	4.965
351		4.725	0.030	0.210	0.005	5.145	5.122	5.125	4.785	4.750	4.753	5.090

\*X = Standard Offering.

Those Piston O.D.'s shown in shaded area may over stretch the o-ring. If so, select a material with greater elongation or use a two-piece piston.

Table 11-6. 568 Static O-ring Gland Dimensions — Inch (Continued)

O-ring 2-Size AS568	X*	Seal Dimensions					Piston			Rod		
		Inside Diameter	±	Width	±	Mean O.D. (Ref)	A	B	C	D	E	F
							Piston Diameter	Bore Diameter	Groove Diameter	Rod Diameter	Throat Diameter	Groove Diameter
							+ .000/- .001	+ .002/- .000	+ .000/- .004	+ .000/- .002	+ .001/- .000	+ .004/- .000
352		4.850	0.030	0.210	0.005	5.270	5.247	5.250	4.910	4.875	4.878	5.215
353		4.975	0.037	0.210	0.005	5.395	5.372	5.375	5.035	5.000	5.003	5.340
354		5.100	0.037	0.210	0.005	5.520	5.497	5.500	5.160	5.125	5.128	5.465
355		5.225	0.037	0.210	0.005	5.645	5.622	5.625	5.285	5.250	5.253	5.590
356		5.350	0.037	0.210	0.005	5.770	5.747	5.750	5.410	5.375	5.378	5.715
357		5.475	0.037	0.210	0.005	5.895	5.872	5.875	5.535	5.500	5.503	5.840
358		5.600	0.037	0.210	0.005	6.020	5.997	6.000	5.660	5.625	5.628	5.965
359		5.725	0.037	0.210	0.005	6.145	6.122	6.125	5.785	5.750	5.753	6.090
360		5.850	0.037	0.210	0.005	6.270	6.247	6.250	5.910	5.875	5.878	6.215
361		5.975	0.037	0.210	0.005	6.395	6.372	6.375	6.035	6.000	6.003	6.340
362		6.225	0.040	0.210	0.005	6.645	6.622	6.625	6.285	6.250	6.253	6.590
363		6.475	0.040	0.210	0.005	6.895	6.872	6.875	6.535	6.500	6.503	6.840
364		6.725	0.040	0.210	0.005	7.145	7.122	7.125	6.785	6.750	6.753	7.090
365		6.975	0.040	0.210	0.005	7.395	7.372	7.375	7.035	7.000	7.003	7.340
425		4.475	0.033	0.275	0.006	5.025	4.996	5.000	4.548	4.500	4.504	4.952
426		4.600	0.033	0.275	0.006	5.150	5.121	5.125	4.673	4.625	4.629	5.077
427		4.725	0.033	0.275	0.006	5.275	5.246	5.250	4.798	4.750	4.754	5.202
428		4.850	0.033	0.275	0.006	5.400	5.371	5.375	4.923	4.875	4.879	5.327
429		4.975	0.037	0.275	0.006	5.525	5.496	5.500	5.048	5.000	5.004	5.452
430		5.100	0.037	0.275	0.006	5.650	5.621	5.625	5.173	5.125	5.129	5.577
431		5.225	0.037	0.275	0.006	5.775	5.746	5.750	5.298	5.250	5.254	5.702
432	X	5.350	0.037	0.275	0.006	5.900	5.871	5.875	5.423	5.375	5.379	5.827
433		5.475	0.037	0.275	0.006	6.025	5.996	6.000	5.548	5.500	5.504	5.952
434		5.600	0.037	0.275	0.006	6.150	6.121	6.125	5.673	5.625	5.629	6.077
435		5.725	0.037	0.275	0.006	6.275	6.246	6.250	5.798	5.750	5.754	6.202
436		5.850	0.037	0.275	0.006	6.400	6.371	6.375	5.923	5.875	5.879	6.327
437		5.975	0.037	0.275	0.006	6.525	6.496	6.500	6.048	6.000	6.004	6.452
438		6.225	0.040	0.275	0.006	6.775	6.746	6.750	6.298	6.250	6.254	6.702
439		6.475	0.040	0.275	0.006	7.025	6.996	7.000	6.548	6.500	6.504	6.952
440		6.725	0.040	0.275	0.006	7.275	7.246	7.250	6.798	6.750	6.754	7.202
441		6.975	0.040	0.275	0.006	7.525	7.496	7.500	7.048	7.000	7.004	7.452

\*X = Standard Offering.

Those Piston O.D.'s shown in shaded area may over stretch the o-ring. If so, select a material with greater elongation or use a two-piece piston.

NOTE: For sizes larger than those shown in the table, please contact your local Parker representative.

# Urethane Head Seal HS Profile

Catalog EPS 5370/USA

## HS Profile, Static Head Seal



As mobile equipment OEM's continue to consider warranty costs, one area of focus has been a review of down time related to cylinder head glands. Two of the most common seal failures on cylinder heads are o-ring back-up blow-out and pinched back-ups. Both failures are common in systems with high eccentricities or large extrusion gaps. To address these situations and to reduce down time HS Profile static head seals are specified to replace the industry-standard o-ring and back-up. Incorporating high performance plastics with a stable, symmetrical geometry, dramatically reduces the risks of installation damage and back-up blow-out. Both problems are eliminated with the HS Profile's one piece urethane design offering improved fit and a stable geometry.

## Technical Data

**Standard  
Materials\***  
P4700A90

**Temperature**  
-65°F to 200°F  
(-54°C to 93°C)

**Pressure**  
10,000 psi (688 bar) static

**\*Alternate Materials:** For applications that may require an alternate material, please contact your local Parker Seal representative.

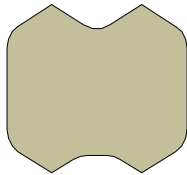

*HS Cross Section*

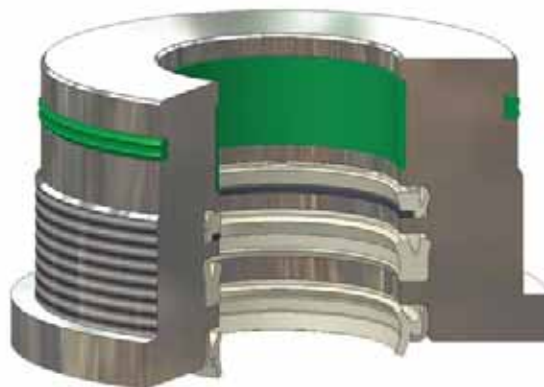

*HS installed in Static Head Gland*

## HS Profile

### Part Number Nomenclature —HS Profile

Table 11-7. HS Profile — Inch

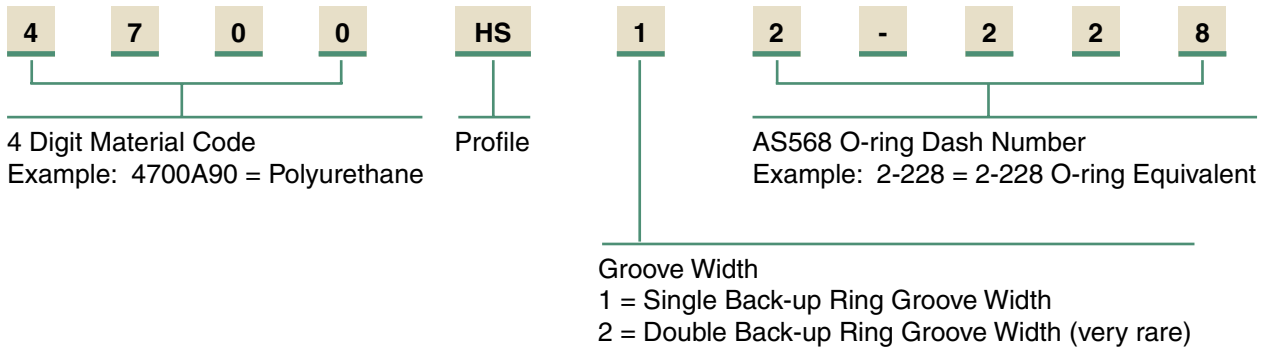

### Gland Dimensions — HS Profile

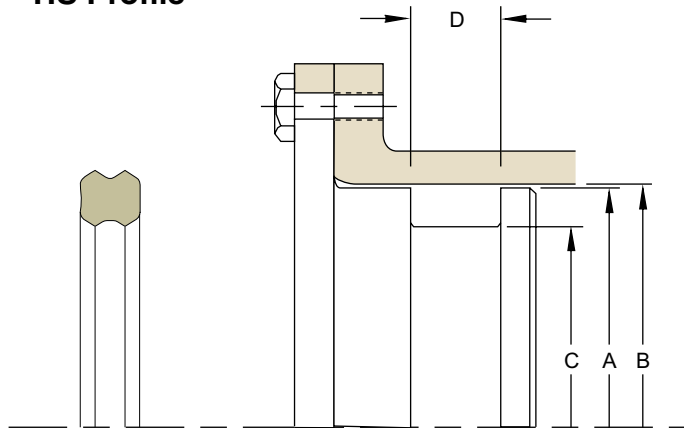

Table 11-8. HS Gland Dimensions — Inch

O-ring 2-Size AS568	Gland Dimensions				Part Number
	A Head Diameter	B Bore Diameter	C Groove Diameter	D Groove Width	
	<b>+0.000/-0.001</b>	<b>+0.002/-0.000</b>	<b>+0.000/-0.002</b>	<b>+0.005/-0.000</b>	
228	2.497	2.500	2.278	0.208	<b>4700HS12-228</b>
230	2.747	2.750	2.528	0.208	<b>4700HS12-230</b>
232	2.997	3.000	2.778	0.208	<b>4700HS12-232</b>
234	3.247	3.250	3.028	0.208	<b>4700HS12-234</b>
235	3.372	3.375	3.153	0.208	<b>4700HS12-235</b>
236	3.497	3.500	3.278	0.208	<b>4700HS12-236</b>
238	3.747	3.750	3.528	0.208	<b>4700HS12-238</b>
240	3.997	4.000	3.778	0.208	<b>4700HS12-240</b>
242	4.247	4.250	4.028	0.208	<b>4700HS12-242</b>
244	4.497	4.500	4.278	0.208	<b>4700HS12-244</b>
246	4.747	4.750	4.528	0.208	<b>4700HS12-246</b>
248	4.997	5.000	4.778	0.208	<b>4700HS12-248</b>
	<b>+0.000/-0.001</b>	<b>+0.002/-0.000</b>	<b>+0.000/-0.004</b>	<b>+0.005/-0.000</b>	
250	5.247	5.250	5.028	0.208	<b>4700HS12-250</b>
251	5.372	5.375	5.153	0.208	<b>4700HS12-251</b>

Table 11-8. HS Gland Dimensions — Inch (Continued)

O-ring 2-Size AS568	Gland Dimensions				Part Number
	A Head Diameter	B Bore Diameter	C Groove Diameter	D Groove Width	
	<b>+0.000/-0.001</b>	<b>+0.002/-0.000</b>	<b>+0.000/-0.004</b>	<b>+0.005/-0.000</b>	
252	5.497	5.500	5.278	0.208	<b>4700HS12-252</b>
254	5.747	5.750	5.528	0.208	<b>4700HS12-254</b>
256	5.997	6.000	5.778	0.208	<b>4700HS12-256</b>
342	3.997	4.000	3.660	0.311	<b>4700HS12-342</b>
344	4.247	4.250	3.910	0.311	<b>4700HS12-344</b>
346	4.497	4.500	4.160	0.311	<b>4700HS12-346</b>
348	4.747	4.750	4.410	0.311	<b>4700HS12-348</b>
350	4.997	5.000	4.660	0.311	<b>4700HS12-350</b>
352	5.247	5.250	4.910	0.311	<b>4700HS12-352</b>
353	5.372	5.375	5.035	0.311	<b>4700HS12-353</b>
354	5.497	5.500	5.160	0.311	<b>4700HS12-354</b>
356	5.747	5.750	5.410	0.311	<b>4700HS12-356</b>
358	5.997	6.000	5.660	0.311	<b>4700HS12-358</b>
360	6.247	6.250	5.910	0.311	<b>4700HS12-360</b>

NOTE: For sizes larger than those shown in the table, please contact your local Parker Seal representative.





# Fluid Power Seal Design Guide Appendix Table of Contents

**Design Action Request Form**

**A**

**English/Metric Conversions**

**B**

**Custom Groove Calculations**

**C**

**Chemical Compatibility**

**D**

**ASTM D2000 Compatibility**

**E**

**ISO Gland Tolerances**

**F**

**Other Parker EPS Products**

**G**



**Parker Hannifin Corporation**  
Engineered Polymer Systems Division  
Phone: 801 972 3000  
Fax: 801 973 4019

[www.parkerseals.com](http://www.parkerseals.com)





# Design Action Request Form

Catalog EPS 5370/USA

NEED HELP? If you need assistance, please photocopy these pages. Fill out the required information and fax to 801 973 4019. Submit a sketch if necessary. Use the information below and other information in this catalog to determine the dimensions needed. We will contact you to discuss your specific application and make recommendations. If you need help filling out this form, please call Applications Engineering at 801 972 3000.

## ENGINEERED POLYMER SYSTEMS DIVISION DESIGN ACTION REQUEST

### EPS Division

2220 South 3600 West  
Salt Lake City, UT  
Tel: (801) 972-3000  
Fax: (801) 973-4019

### Applications Engineering Use:

Project # \_\_\_\_\_  
Date Entered \_\_\_\_\_  
Date Required \_\_\_\_\_  
Prepared by \_\_\_\_\_  
Territory Mgr. \_\_\_\_\_  
Distributor \_\_\_\_\_  
Dist. Sales \_\_\_\_\_

Referred by \_\_\_\_\_  
Lead # \_\_\_\_\_

COMPANY: \_\_\_\_\_ FAX NUMBER: \_\_\_\_\_  
ADDRESS: \_\_\_\_\_ P.O. BOX: \_\_\_\_\_ MAIL STOP: \_\_\_\_\_  
CITY: \_\_\_\_\_ STATE: \_\_\_\_\_ ZIP: \_\_\_\_\_ COUNTRY: \_\_\_\_\_  
CONTACT: \_\_\_\_\_ TITLE: \_\_\_\_\_ PHONE: \_\_\_\_\_ EXT: \_\_\_\_\_  
ALT. CONTACT: \_\_\_\_\_ TITLE: \_\_\_\_\_ PHONE: \_\_\_\_\_ EXT: \_\_\_\_\_  
E-MAIL: \_\_\_\_\_

EQUIPMENT/MANUFACTURER: \_\_\_\_\_ MODEL NO.: \_\_\_\_\_  
EXISTING SEAL MANUFACTURER: \_\_\_\_\_ PART NO.: \_\_\_\_\_  
**REASON FOR CHANGE:**  PERFORMANCE  DELIVERY  NEW APPLICATION  PRICE  
CURRENT PRICE: \_\_\_\_\_ @ \_\_\_\_\_ PCS. MONTHLY USAGE: \_\_\_\_\_ HOURS OPERATION: \_\_\_\_\_ HOURS SERV. LIFE: \_\_\_\_\_  
TARGET PRICE: \_\_\_\_\_ @ \_\_\_\_\_ PCS. QUOTE QTY.: \_\_\_\_\_ PROTO QTY.: \_\_\_\_\_ DATE PROTO REQ'D.: \_\_\_\_\_  
SPECIAL INSPECTION REQUIREMENTS:  YES  NO SPECIAL PACKAGING REQUIREMENTS:  YES  NO  
EXPLAIN: \_\_\_\_\_

### MOTION

STATIC  RECIPROCATING  OSCILLATORY  ROTARY

### PRODUCT TYPE

NON-ROTARY — FILL OUT SECOND PAGE

ROD/SHAFT  WIPER  
 PISTON  BEARING  
 INTERNAL FACE  VANE  
 EXTERNAL FACE  NON-SEAL

ROTARY — FILL OUT THIRD PAGE

SOLID SEAL  PTFE LIP SEAL  
 SPLIT SEAL  ELASTOMER LIP SEAL  
 BEARING ISOLATOR

09/01/07



# Design Action Request Form

**A**

**OPERATING PARAMETERS**

TEMPERATURE: \_\_\_\_\_  
 PRESSURE: \_\_\_\_\_  
 STROKE LENGTH (RECIPROCATING): \_\_\_\_\_  
 CYCLE RATE: \_\_\_\_\_  
 DEGREE OF ARC (OSCILLATING): \_\_\_\_\_  
 VELOCITY: \_\_\_\_\_  
 VACUUM: \_\_\_\_\_  
 ROTARY SPEED \_\_\_\_\_  
 MEDIA TO BE SEALED: \_\_\_\_\_

**UNIT (CIRCLE ONE)**

°K °F °C  
 PSI BAR MPA  
 INCH MM  
 CYCLES/MIN CYCLES/HR HZ  
 DEGREES  
 FT/MIN. MM/MIN.  
 IN HG TORR  
 RPM

**MINIMUM**

\_\_\_\_\_  
 \_\_\_\_\_  
 \_\_\_\_\_  
 \_\_\_\_\_  
 \_\_\_\_\_  
 \_\_\_\_\_  
 \_\_\_\_\_

**OPERATING**

\_\_\_\_\_  
 \_\_\_\_\_  
 \_\_\_\_\_  
 \_\_\_\_\_  
 \_\_\_\_\_  
 \_\_\_\_\_  
 \_\_\_\_\_

**MAXIMUM**

\_\_\_\_\_  
 \_\_\_\_\_  
 \_\_\_\_\_  
 \_\_\_\_\_  
 \_\_\_\_\_  
 \_\_\_\_\_  
 \_\_\_\_\_

**Rod**

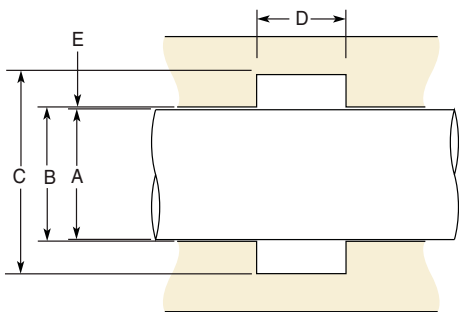

**Piston**

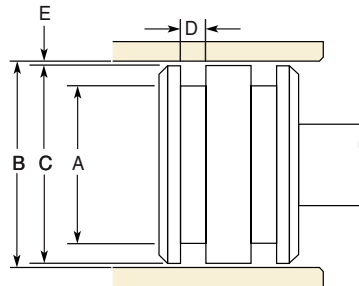

**Face Seal**

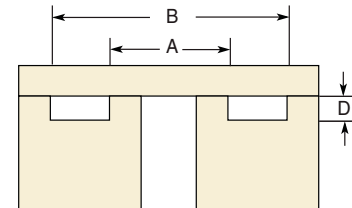

**Other Piston**

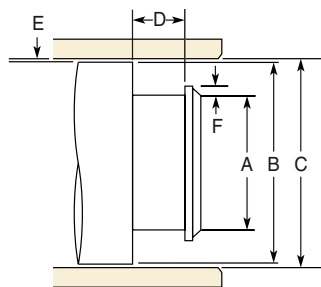

**Other Rod**

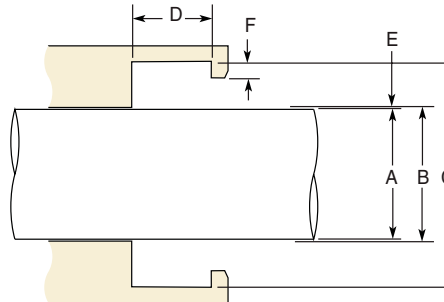

**HARDWARE SPECIFICATIONS**

A DIAMETER: MIN. \_\_\_\_\_ MAX. \_\_\_\_\_  
 B DIAMETER: MIN. \_\_\_\_\_ MAX. \_\_\_\_\_  
 C DIAMETER: MIN. \_\_\_\_\_ MAX. \_\_\_\_\_  
 D GROOVE WIDTH: MIN. \_\_\_\_\_ MAX. \_\_\_\_\_  
 E RADIAL CLEARANCE: MIN. \_\_\_\_\_ MAX. \_\_\_\_\_  
 F ROD / PISTON STEP HEIGHT: MIN. \_\_\_\_\_ MAX. \_\_\_\_\_

**HARDWARE DRAWINGS INCLUDED WITH DAR:**  YES  NO

HARDNESS \_\_\_\_\_ FINISH \_\_\_\_\_ MAT'L \_\_\_\_\_  
 HARDNESS \_\_\_\_\_ FINISH \_\_\_\_\_ MAT'L \_\_\_\_\_  
 HARDNESS \_\_\_\_\_ FINISH \_\_\_\_\_ MAT'L \_\_\_\_\_  
 CAN HARDWARE BE CHANGED?  YES  NO  
 HOW? \_\_\_\_\_

SIDE LOAD (LBS. NEWTONS): \_\_\_\_\_  
 MIL-G-5514 O-RING DASH #: \_\_\_\_\_ BACK-UP WIDTH \_\_\_\_\_  
 AS4716 O-RING DASH #: \_\_\_\_\_ BACK-UP WIDTH \_\_\_\_\_  
 RUNOUT (TIR) \_\_\_\_\_  
 ECCENTRICITY \_\_\_\_\_

**PERFORMANCE REQUIREMENTS (CIRCLE ONE)**

FRICITION: LBS OZ GMS BREAKOUT \_\_\_\_\_ DYNAMIC \_\_\_\_\_  
 EXPECTED LIFE: CYC HRS YRS \_\_\_\_\_  
 MAX. LEAKAGE: DROPS CC/MIN \_\_\_\_\_  
 MOST CRITICAL ASPECT: \_\_\_\_\_  
 CONTAMINATION: \_\_\_\_\_

**GLAND TYPE**

\_\_\_ SPLIT \_\_\_ OPEN

**METRIC**

YES

# English / Metric Conversions: Fractions

Catalog EPS 5370/USA

**B**

Fractional	Decimal	Metric
—	0.004	0.10
—	0.010	0.25
1/64	0.016	0.40
—	0.020	0.50
—	0.030	0.75
1/32	0.031	0.79
—	0.039	1.00
3/64	0.047	1.19
—	0.059	1.50
1/16	0.063	1.59
5/64	0.078	1.98
—	0.079	2.00
3/32	0.094	2.38
—	0.098	2.50
7/64	0.109	2.78
—	0.118	3.00
1/8	0.125	3.18
—	0.138	3.50
9/64	0.141	3.57
5/32	0.156	3.97
—	0.158	4.00
11/64	0.172	4.37
—	0.177	4.50
3/16	0.188	4.76
—	0.197	5.00
13/64	0.203	5.16
—	0.217	5.50
7/32	0.219	5.56
15/64	0.234	5.95
—	0.236	6.00
1/4	0.250	6.35
—	0.256	6.50
17/64	0.266	6.75
—	0.276	7.00
9/32	0.281	7.14
—	0.295	7.50
19/64	0.297	7.54
5/16	0.313	7.94
—	0.315	8.00
21/64	0.328	8.33
—	0.335	8.50
11/32	0.344	8.73
—	0.354	9.00
23/64	0.359	9.13
—	0.374	9.50
3/8	0.375	9.53
25/64	0.391	9.92
—	0.394	10.00
12/32	0.406	10.32
—	0.413	10.50
27/64	0.422	10.72
—	0.433	11.00
7/16	0.438	11.11
29/64	0.453	11.51
15/32	0.469	11.91
—	0.472	12.00
31/64	0.484	12.30
—	0.492	12.50
1/2	0.500	12.70
—	0.512	13.00
33/64	0.516	13.10
17/32	0.531	13.50
35/64	0.547	13.90
—	0.551	14.00
9/16	0.563	14.29
—	0.571	14.50

Fractional	Decimal	Metric
37/64	0.578	14.68
—	0.591	15.00
19/32	0.594	15.08
39/64	0.609	15.48
5/8	0.625	15.88
—	0.630	16.00
41/64	0.641	16.27
—	0.650	16.50
21/32	0.656	16.67
—	0.669	17.00
43/64	0.672	17.01
11/16	0.688	17.46
45/64	0.703	17.86
—	0.709	18.00
23/32	0.719	18.26
—	0.728	18.49
47/64	0.734	18.65
—	0.748	19.00
3/4	0.750	19.05
49/64	0.766	19.45
25/32	0.781	19.84
—	0.787	20.00
51/64	0.797	20.24
13/16	0.813	20.64
—	0.827	21.00
53/64	0.828	21.03
27/32	0.844	21.43
55/64	0.859	21.83
—	0.866	22.00
7/8	0.875	22.23
57/64	0.891	22.62
—	0.906	23.00
29/32	0.906	23.02
59/64	0.922	23.42
15/16	0.938	23.81
—	0.945	24.00
61/64	0.953	24.21
31/32	0.969	24.61
—	0.984	25.00
1	1.000	25.40
—	1.024	26.00
1 1/32	1.031	26.19
1 1/16	1.062	26.99
—	1.063	27.00
1 3/32	1.094	27.78
—	1.102	28.00
1 1/8	1.125	28.58
—	1.148	29.00
1 5/32	1.156	29.37
—	1.181	30.00
1 3/16	1.188	30.16
1 7/32	1.219	30.96
—	1.221	31.00
1 1/4	1.250	31.75
—	1.260	32.00
1 9/32	1.281	32.54
—	1.299	33.00
1 5/16	1.312	33.34
—	1.339	34.00
1 11/32	1.344	34.13
1 3/8	1.375	34.93
—	1.378	35.00
1 13/32	1.406	35.72
—	1.417	36.00
1 7/16	1.438	36.51
—	1.457	37.00

Fractional	Decimal	Metric
1 15/32	1.469	37.31
—	1.496	38.00
1 1/2	1.500	38.10
1 17/32	1.531	38.89
—	1.535	39.00
1 9/16	1.562	39.69
—	1.575	40.00
1 19/64	1.594	40.48
—	1.614	41.00
1 5/8	1.625	41.28
—	1.654	42.00
1 21/32	1.656	42.07
1 11/16	1.688	42.86
—	1.693	43.00
1 23/32	1.719	43.66
—	1.732	44.00
1 3/4	1.750	44.50
—	1.772	45.00
1 25/32	1.781	45.24
—	1.811	46.00
1 13/16	1.813	46.04
1 27/32	1.844	46.83
—	1.850	47.00
1 7/8	1.875	47.63
—	1.890	48.00
1 29/32	1.906	48.42
—	1.929	49.00
1 15/16	1.938	49.21
—	1.970	50.00
1 31/32	1.970	50.01
2	2.000	50.80
—	2.008	51.00
—	2.047	52.00
2 1/16	2.062	52.39
—	2.087	53.00
2 1/8	2.125	53.98
—	2.126	54.00
—	2.165	55.00
2 3/16	2.188	55.56
—	2.205	56.00
—	2.244	57.00
2 1/4	2.250	57.15
—	2.284	58.00
2 5/16	2.312	58.74
—	2.323	59.00
—	2.362	60.00
2 3/8	2.375	60.33
—	2.402	61.00
2 7/16	2.438	61.91
—	2.441	62.00
—	2.480	63.00
2 1/2	2.500	63.50
—	2.520	64.00
—	2.559	65.00
2 9/16	2.562	65.09
—	2.598	66.00
2 5/8	2.625	66.68
—	2.638	67.00
—	2.677	68.00
2 11/16	2.688	68.26
—	2.717	69.00
2 3/4	2.750	69.85
—	2.756	70.00
—	2.795	71.00
2 13/16	2.813	71.44
—	2.835	72.00

Fractional	Decimal	Metric
—	2.874	73.00
2 7/8	2.875	73.03
—	2.913	74.00
2 15/16	2.938	74.61
—	2.953	75.00
—	2.992	76.00
3	3.000	76.20
—	3.032	77.00
3 1/16	3.062	77.79
—	3.071	78.00
—	3.110	79.00
3 1/8	3.125	79.38
—	3.150	80.00
3 3/16	3.188	80.96
—	3.189	81.00
—	3.228	82.00
3 1/4	3.250	82.55
—	3.268	83.00
—	3.307	84.00
3 5/16	3.312	84.14
—	3.346	85.00
3 3/8	3.375	85.73
—	3.386	86.00
—	3.425	87.00
3 7/16	3.438	87.31
—	3.465	88.00
3 1/2	3.500	88.90
—	3.504	89.00
—	3.543	90.00
3 9/16	3.562	90.49
—	3.583	91.00
—	3.622	92.00
3 5/8	3.625	92.08
—	3.661	93.00
3 11/16	3.688	93.66
—	3.701	94.00
—	3.740	95.00
3 3/4	3.750	95.25
—	3.780	96.00
3 13/16	3.813	96.84
—	3.819	97.00
—	3.858	98.00
3 7/8	3.875	98.43
—	3.898	99.00
—	3.937	100.00
3 15/16	3.938	100.01
—	3.976	101.00
4	4.000	101.60
4 1/16	4.062	103.19
4 1/8	4.125	104.78
—	4.134	105.00
4 3/16	4.188	106.36
4 1/4	4.250	107.95
4 5/16	4.312	109.54
—	4.331	110.00
4 3/8	4.375	111.13
4 7/16	4.438	112.71
4 1/2	4.500	114.30
—	4.528	115.00
4 9/16	4.562	115.89
4 5/8	4.625	117.48
—	4.724	120.00
4 3/4	4.750	120.65
4 7/8	4.875	123.83
—	4.921	125.00
5	5.000	127.00

09/01/07



# RPM to FPM Conversion

**B**

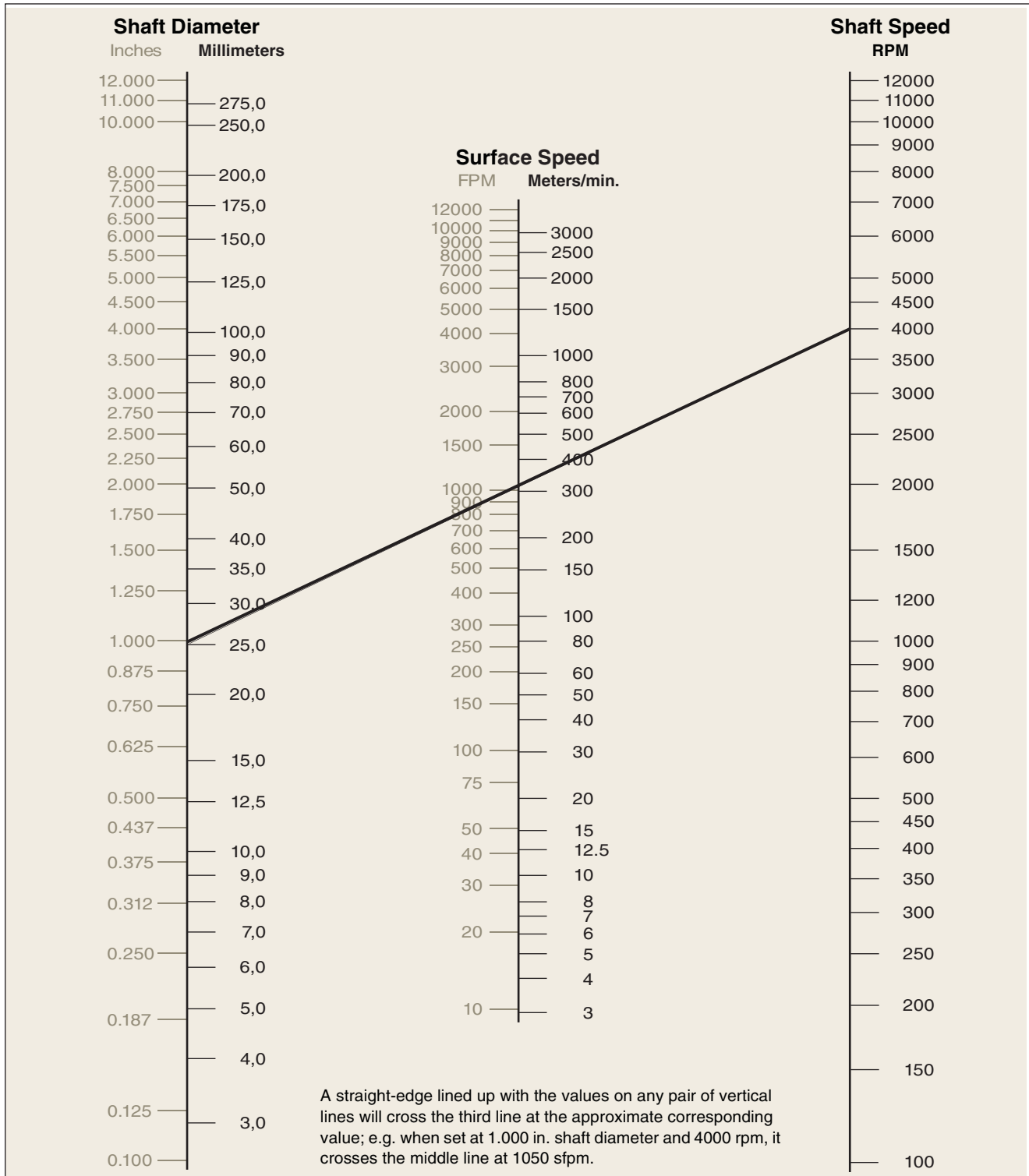



# Pressure: PSI / Bar

1-40		41-80		81-200		205-500		510-900		910-1500	
psi	bar	psi	bar	psi	bar	psi	bar	psi	bar	psi	bar
1	0.07	41	2.83	81	5.59	205	14.13	510	35.17	910	62.76
2	0.14	42	2.90	82	5.65	210	14.48	520	35.86	920	63.45
3	0.21	43	2.97	83	5.72	215	14.82	530	36.55	930	64.14
4	0.28	44	3.03	84	5.79	220	15.17	540	37.24	940	64.83
5	0.34	45	3.10	85	5.86	225	15.51	550	37.92	950	65.52
6	0.41	46	3.17	86	5.93	230	15.86	560	38.62	960	66.21
7	0.48	47	3.24	87	6.00	235	16.20	570	39.31	970	66.90
8	0.55	48	3.31	88	6.07	240	16.55	580	40.00	980	67.59
9	0.62	49	3.38	89	6.14	245	16.89	590	40.69	990	68.28
10	0.69	50	3.45	90	6.21	250	17.24	600	41.37	1000	68.95
11	0.76	51	3.52	91	6.27	255	17.58	610	42.07	1010	69.66
12	0.83	52	3.59	92	6.34	260	17.93	620	42.76	1020	70.34
13	0.90	53	3.65	93	6.41	265	18.27	630	43.45	1030	71.03
14	0.97	54	3.72	94	6.48	270	18.62	640	44.14	1040	71.72
15	1.03	55	3.79	95	6.55	275	18.96	650	44.82	1050	72.41
16	1.10	56	3.86	96	6.62	280	19.31	660	45.52	1060	73.10
17	1.17	57	3.93	97	6.69	285	19.65	670	46.21	1070	73.79
18	1.24	58	4.00	98	6.76	290	20.00	680	46.90	1080	74.48
19	1.31	59	4.07	99	6.83	295	20.34	690	47.59	1090	75.17
20	1.38	60	4.14	100	6.90	300	20.69	700	48.27	1100	75.86
21	1.45	61	4.21	105	7.24	310	21.37	710	48.97	1120	77.24
22	1.52	62	4.28	110	7.58	320	22.06	720	49.66	1140	78.62
23	1.59	63	4.34	115	7.93	330	22.75	730	50.34	1160	80.00
24	1.65	64	4.41	120	8.27	340	23.44	740	51.03	1180	81.38
25	1.72	65	4.48	125	8.62	350	24.13	750	51.71	1200	82.76
26	1.79	66	4.55	130	8.89	360	24.82	760	52.41	1220	84.14
27	1.86	67	4.62	135	9.31	370	25.51	770	53.10	1240	85.52
28	1.93	68	4.69	140	9.65	380	26.21	780	53.79	1260	86.90
29	2.00	69	4.76	145	10.10	390	26.89	790	54.48	1280	88.28
30	2.07	70	4.83	150	10.34	400	27.58	800	55.16	1300	89.66
31	2.14	71	4.90	155	10.69	410	28.27	810	55.86	1320	91.03
32	2.21	72	4.97	160	11.03	420	28.96	820	56.55	1340	92.41
33	2.28	73	5.03	165	11.38	430	29.65	830	57.24	1360	93.79
34	2.34	74	5.10	170	11.72	440	30.34	840	57.93	1380	95.17
35	2.41	75	5.17	175	12.07	450	31.03	850	58.61	1400	96.55
36	2.48	76	5.24	180	12.41	460	31.72	860	59.31	1420	97.93
37	2.55	77	5.31	185	12.76	470	32.41	870	60.00	1440	99.31
38	2.62	78	5.38	190	13.10	480	33.10	880	60.69	1460	100.69
39	2.69	79	5.45	195	13.45	490	33.79	890	61.38	1480	102.07
40	2.76	80	5.52	200	13.79	500	34.48	900	62.06	1500	103.45





# Temperature: Celsius / Fahrenheit

**B**

Celsius	Fahrenheit
-169	-273
-168	-270
-162	-260
-157	-250
-151	-240
-146	-230
-140	-220
-134	-210
-129	-200
-123	-190
-118	-180
-112	-170
-107	-160
-101	-150
-96	-140
-90	-130
-84	-120
-79	-110
-73	-100
-68	-90
-62	-80
-57	-70
-51	-60
-46	-50
-40	-40
-34	-30
-29	-20
-23	-10
-17.8	0
-17.2	1
-16.7	2
-16.1	3
-15.6	4
-15	5
-14.4	6
-13.9	7
-13.3	8
-12.8	9
-12.2	10
-11.7	11
-11.1	12
-10.6	13
-10	14
-9.4	15
-8.9	16
-8.3	17

Celsius	Fahrenheit
-7.8	18
-7.2	19
-6.7	20
-6.1	21
-5.6	22
-5	23
-4.4	24
-3.9	25
-3.3	26
-2.8	27
-2.2	28
-1.7	29
-1.1	30
-0.6	31
0	32
0.6	33
1.1	34
1.7	35
2.2	36
2.8	37
3.3	38
3.9	39
4.4	40
5	41
5.6	42
6.1	43
6.7	44
7.2	45
7.8	46
8.3	47
8.9	48
9.4	49
10	50
10.6	51
11.1	52
11.7	53
12.2	54
12.8	55
13.3	56
13.9	57
14.4	58
15	59
15.6	60
16.1	61
16.7	62
17.2	63

Celsius	Fahrenheit
17.8	64
18.3	65
18.9	66
19.4	67
20	68
20.6	69
21.1	70
21.7	71
22.2	72
22.8	73
23.3	74
23.9	75
24.4	76
25	77
25.6	78
26.1	79
26.7	80
27.2	81
27.8	82
28.3	83
28.9	84
29.4	85
30	86
30.6	87
31.1	88
31.7	89
32.2	90
32.8	91
33.3	92
33.9	93
34.4	94
35	95
35.6	96
36.1	97
36.7	98
37.2	99
37.8	100
43	110
49	120
54	130
60	140
66	150
71	160
77	170
82	180
88	190

Celsius	Fahrenheit
93	200
99	210
100	212
104	220
110	230
116	240
121	250
127	260
132	270
138	280
143	290
149	300
154	310
160	320
166	330
171	340
177	350
182	360
188	370
193	380
199	390
204	400
210	410
216	420
221	430
227	440
232	450
238	460
243	470
249	480
254	490
260	500
266	510
271	520
277	530
282	540
288	550
293	560
299	570
304	580
310	590
316	600
321	610
327	620
332	630
338	640

Celsius	Fahrenheit
343	650
349	660
354	670
360	680
366	690
371	700
377	710
382	720
388	730
393	740
399	750
404	760
410	770
416	780
421	790
427	800
432	810
438	820
443	830
449	840
454	850
460	860
466	870
471	880
477	890
482	900
488	910
493	920
499	930
504	940
510	950
516	960
521	970
527	980
532	990
538	1000
549	1020
560	1040
571	1060
582	1080
593	1100
604	1120
616	1140
627	1160
638	1180
649	1200

# Custom Groove Dimensions

## Contents

Piston Gland.....C-1  
Rod Gland .....C-2  
Wiper Gland.....C-2  
Piston Wear Ring.....C-3  
Rod Wear Ring .....C-3

There are times when using standard seal groove dimensions is not an option. Whether it is for cylinders that have been refinished or off sized metal, there are some simple calculations to use to determine what the appropriate groove dimensions should be. The formulas for calculating custom groove dimensions are included below.



## Piston Gland Custom Groove Calculation

Subtract the standard bore diameter from the next smallest standard bore diameter to determine the Offset Factor. Apply the Offset Factor to the Groove Diameter, *X*, and the Shoulder Diameter, *Y*, as shown below. Groove Width, *Z*, will remain unchanged.

Offset Factor Diameter:

$$\left( \begin{array}{c} \text{Offset} \\ \text{Factor} \end{array} \right) = \left( \begin{array}{c} \text{Required} \\ \text{Bore Diameter} \end{array} \right) - \left( \begin{array}{c} \text{Standard} \\ \text{Bore Diameter} \end{array} \right)$$

New Groove Diameter, *X*:

$$X = \left( \begin{array}{c} \text{Standard} \\ \text{Groove Diameter} \end{array} \right) + \left( \begin{array}{c} \text{Offset} \\ \text{Factor} \end{array} \right)$$

New Piston Diameter, *Y*:

$$Y = \left( \begin{array}{c} \text{Standard} \\ \text{Piston Diameter} \end{array} \right) + \left( \begin{array}{c} \text{Offset} \\ \text{Factor} \end{array} \right)$$

If the required diameter is smaller than the standard diameter, a negative Offset Factor will be calculated, and the piston seal will be compressed. In most circumstances, Parker advises against compressing smaller sizes of piston seals to fit oversized bores. Please contact your local Parker representative for assistance in these cases.

**IMPORTANT:** It is necessary to calculate the additional stretch that the piston seal will be subjected to. Do this by using the equation below:

$$\left( \begin{array}{c} \text{Additional} \\ \text{Stretch \%} \end{array} \right) = \left( \frac{\text{Offset Factor}}{\text{Standard Bore Diameter}} \right) \times 100$$

Parker recommends that the Additional Stretch Percentage not exceed 5%. If this percentage does exceed 5%, please contact your local Parker representative for assistance.

# Rod Seal and Rod Wiper Custom Groove Calculation

Catalog EPS 5370/USA

Subtract the required rod diameter from the next largest standard rod diameter to determine the Offset Factor. Apply the Offset Factor to the Groove Diameter, X, and the Throat Diameter, Y, as shown below. Groove Width, Z, will remain unchanged.

Offset Factor Diameter

$$\left( \frac{\text{Offset}}{\text{Factor}} \right) = \left( \frac{\text{Standard}}{\text{Rod Diameter}} \right) - \left( \frac{\text{Required}}{\text{Rod Diameter}} \right)$$

New Groove Diameter, X:

$$X = \left( \frac{\text{Standard}}{\text{Groove Diameter}} \right) - \left( \frac{\text{Offset}}{\text{Factor}} \right)$$

New Shoulder Diameter, Y:

$$Y = \left( \frac{\text{Standard}}{\text{Shoulder Diameter}} \right) - \left( \frac{\text{Offset}}{\text{Factor}} \right)$$

If the required diameter is larger than the standard diameter, a negative Offset Factor will be calculated, and the rod seal will be stretched. In most circumstances, Parker advises against stretching smaller sizes of rod seals to fit oversized rods. Please contact your local Parker representative for assistance in these cases.

**IMPORTANT:** It is necessary to calculate the additional compression that the rod seal will be subjected to. Do this by using the equation below:

$$\left( \frac{\text{Additional}}{\text{Compression \%}} \right) = \left( \frac{\text{Offset Factor}}{\text{Standard Bore Diameter}} \right) \times 100$$

Parker recommends that the Additional Compression Percentage not exceed 2%. If this percentage does exceed 2%, please contact your local Parker representative for assistance.

# Piston Wear Ring / Bearing Groove Calculation

The formula for calculating piston wear ring grooves using alternative extrusion gaps, metal-to-metal clearances and machining tolerances:

1. Maximum Groove Diameter, B:

$$B = \left( \frac{\text{Minimum Bore}}{\text{Diameter, A}} \right) - .001" = 2 \times \left( \frac{\text{Max. Cross}}{\text{Section}} \right)$$

2. Minimum Groove Diameter:

$$\left( \frac{\text{Minimum}}{\text{Groove Diameter}} \right) = B - \left( \frac{\text{Machining}}{\text{Tolerances}} \right)$$

3. Maximum Piston Diameter, C:

$$C = \left( \frac{\text{Min. Groove}}{\text{Diameter}} \right) + 2 \times \left( \frac{\text{Min. Cross}}{\text{Section}} \right) - 2 \times \left( \frac{\text{Desired Min. Radial}}{\text{Metal-to-Metal Clearance}} \right)$$

4. D = (Nominal Width, W) + .010"

$$D = \left( \text{Nominal Width, W} \right) + \left( .010" \right)$$

Notes:

1. Tolerance for dimension D is +.010" / -.000"
2. Groove radii must not exceed .015" max.
3. Parker recommends a minimum .005" radial metal-to-metal clearance. Using the above equations may result in metal-to-metal contact if the material's compressive properties are not considered, contact your local Parker representative for assistance.

09/01/07

# Rod Wear Ring Groove Calculation

Catalog EPS 5370/USA

The formula for calculating rod wear ring grooves using alternative extrusion gaps metal-to-metal clearances and machining tolerances:

5. Maximum Groove Diameter, **BI**:

$$BI = \left( \begin{array}{l} \text{Minimum Rod} \\ \text{Diameter, } A1 \end{array} \right) + .001" = 2 \times \left( \begin{array}{l} \text{Max. Cross} \\ \text{Section} \end{array} \right)$$

6. Maximum Groove Diameter:

$$\left( \begin{array}{l} \text{Minimum} \\ \text{Groove Diameter} \end{array} \right) = BI + \left( \begin{array}{l} \text{Machining} \\ \text{Tolerances} \end{array} \right)$$

7. Minimum Throat Diameter, **CI**:

$$CI = \left( \begin{array}{l} \text{Max. Groove} \\ \text{Diameter} \end{array} \right) - 2 \times \left( \begin{array}{l} \text{Min. Cross} \\ \text{Section} \end{array} \right) + 2 \times \left( \begin{array}{l} \text{Desired Min. Radial} \\ \text{Metal-to-Metal Clearance} \end{array} \right)$$

8. **D** = (Nominal Width, **W**) + .010"

$$D = \left( \begin{array}{l} \text{Nominal Width, } W \end{array} \right) + \left( \begin{array}{l} .010" \end{array} \right)$$

Notes:

5. Tolerance for dimension **D** is +.010" / -.000"

6. Groove radii must not exceed .015" max.

3. Parker recommends a minimum .005" radial metal-to-metal clearance. Using the above equations may result in metal-to-metal contact if the material's compressive properties are not considered, contact your local Parker representative for assistance.

C

09/01/07





# Chemical Compatibility Chart

Catalog EPS 5370/USA

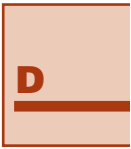

	Points Change Hardness	Percent Change				
		100% Modulus (PSI)	Tensile Strength (PSI)	Elongation (%)	Weight	Volume
<b>Reference Fuel A</b>						
P4300A90	-1	-6	8	1	2	4
P4301A90	0	-5	7	7	2	3
P4304D60	-1	-2	7	-1	1	1
P4311A90	0	3	7	5	2	3
P4500A90	-1	-8	-4	-3	1	2
P6000A90	-1	6	2	-1	1	1
Z4651D60	2	-1	22	-1	2	4
Z4652D65	1	3	-1	3	-2	-1
Z4653D60	-2	-3	-4	25	1	2
N4115A75	-3	2	-12	-18	0	2
N4180A80	-1	-2	-5	-12	0	1
N4181A80	-6	3	-10	-12	2	4
N4121A90	-1	-5	-4	-12	1	1
N4008A80	-5	1	-9	-9	2	6
N0304A75	-5	-2	-25	-20	-2	2
N4257A85	2	11	-10	-23	0	0
N4274A85	0	4	3	5	1	1
N4263A90	-2	-10	1	18	1	1
KB162A80	-2	7	-4	-9	1	1
KB163A90	-3	-6	-6	-1	1	1
N4007A95	0	-2	-6	8	1	2
E4183A80	-21	-	-61	-54	57	93
E4207A90	-3	-18	-15	5	-1	-1
E4259A80	-9	1	-31	-17	24	37
E4270A90	-6	-	-58	-53	43	69
V4205A75	-1	6	11	4	0	0
V4208A90	-2	-2	-10	-6	1	2
V4266A95	0	-5	-2	3	1	2
V4276A85	-9	-59	-38	28	10	22

	Points Change Hardness	Percent Change				
		100% Modulus (PSI)	Tensile Strength (PSI)	Elongation (%)	Weight	Volume
<b>MIL-H-5606</b>						
P4300A90	0	0	35	-15	5	7
P4301A90	-1	-6	0	7	6	8
P4304D60	-3	-2	14	5	5	7
P4311A90	-1	3	8	3	7	9
P4500A90	-3	-8	10	-1	7	9
P6000A90	-3	-3	33	13	6	8
Z4651D60	-2	-1	12	4	7	9
Z4652D65	0	0	12	4	6	8
Z4653D60	-6	1	8	32	7	10
N4115A75	-1	28	10	-24	4	7
N4180A80	-9	5	11	-17	5	8
N4181A80	-12	-6	-16	-24	15	21
N4121A90	-2	13	-3	-28	6	11
N4008A80	-9	16	-18	-32	11	18
N0304A75	-11	20	-20	-31	8	15
N4257A85	1	49	9	-29	2	4
N4274A85	-7	12	17	6	4	6
N4263A90	0	12	17	-2	5	7
KB162A80	-5	-10	-14	-10	10	13
KB163A90	-7	-8	-8	-2	8	11
N4007A95	-2	0	-4	-8	6	9
E4183A80	-25	-58	-67	-57	95	133
E4207A90	-22	-	-68	-58	71	100
E4259A80	-23	-	-70	-66	104	126
E4270A90	-18	-	-53	-54	73	94
V4205A75	-2	1	-11	-4	1	2
V4208A90	-5	-2	-15	-10	2	4
V4266A95	-1	-21	-21	-11	1	3
V4276A85	-7	-46	-13	47	16	25

09/01/07



# Chemical Compatibility



	Points Change Hardness	Percent Change				
		100% Modulus (PSI)	Tensile Strength (PSI)	Elongation (%)	Weight	Volume
<b>Reference Fuel B</b>						
P4300A90	-1	-4	-3	-15	13	18
P4301A90	-1	-12	-27	-9	17	24
P4304D60	-3	-10	-9	-3	8	11
P4311A90	-2	0	-12	-2	13	18
P4500A90	-3	-16	-36	-9	12	17
P6000A90	-3	-13	-30	2	10	14
Z4651D60	-3	-9	-6	-7	7	10
Z4652D65	-4	-9	6	4	0	2
Z4653D60	-7	-5	-8	17	7	10
N4115A75	-9	1	-15	-22	7	13
N4180A80	-10	-12	-19	-29	10	18
N4181A80	-12	-9	-41	-36	20	30
N4121A90	-15	-14	-20	-20	10	17
N4008A80	-10	7	-32	-38	22	38
N0304A75	-15	-10	-51	-40	5	12
N4257A85	-19	-28	-34	-28	13	21
N4274A85	-16	-43	-26	4	17	26
N4263A90	-14	-52	-18	37	15	24
KB162A80	-7	-	-50	-43	16	23
KB163A90	-17	-	-34	-19	14	22
N4007A95	-8	-14	-24	-8	8	10
E4183A80	-20	-5	-56	-53	71	108
E4207A90	-5	-8	-13	-5	-1	-1
E4259A80	-7	0	-4	-4	18	28
E4270A90	-17	-	-53	-33	24	36
V4205A75	-4	9	1	-3	0	1
V4208A90	-4	-6	-17	-9	1	3
V4266A95	-2	-5	-5	4	1	2
V4276A85	-19	-57	-52	1	15	32

	Points Change Hardness	Percent Change				
		100% Modulus (PSI)	Tensile Strength (PSI)	Elongation (%)	Weight	Volume
<b>Jet Oil II</b>						
P4300A90	-1	-3	18	-6	10	12
P4301A90	-1	-9	-2	6	13	15
P4304D60	0	-4	-1	5	5	6
P4311A90	-4	0	16	7	11	13
P4500A90	-3	-7	24	1	10	12
P6000A90	-3	-1	46	14	9	10
Z4651D60	0	-5	-3	-5	7	9
Z4652D60	1	1	1	6	5	6
Z4653D60	-6	3	6	30	6	7
N4115A75	-7	23	12	-21	18	24
N4180A80	-16	-1	10	-2	20	26
N4181A80	-14	-9	-16	-17	31	37
N4121A90	-12	3	2	-16	16	22
N4008A80	-12	17	-15	-30	29	38
N0304A75	-16	28	-31	-43	28	36
N4257A85	-2	40	12	-25	10	11
N4274A85	-3	16	17	0	12	13
N4263A90	-4	-2	9	-3	12	15
KB162A80	-6	-5	-11	-7	14	17
KB163A90	-8	-5	-9	-2	12	15
N4007A95	-20	-8	0	-15	14	18
E4183A80	-11	-11	-5	-4	8	9
E4207A90	-8	-	-19	-15	8	9
E4259A80	-10	3	-8	-8	11	13
E4270A90	-8	-2	0	1	10	11
V4205A75	-6	-2	-34	-16	6	11
V4208A90	-9	-2	-10	-8	5	10
V4266A95	-3	-9	-7	6	4	8
V4276A85	-1	-34	-11	32	5	7





**Chemical Compatibility**

	Points Change Hardness	Percent Change				
		100% Modulus (PSI)	Tensile Strength (PSI)	Elongation (%)	Weight	Volume
<b>Reference Fuel C</b>						
P4300A90	-2	-3	-30	-35	21	29
P4301A90	-2	-13	-26	-6	25	35
P4304D60	-6	-10	-16	-11	11	15
P4311A90	-2	-1	-28	-6	20	27
P4500A90	-5	-17	-38	-11	17	24
P6000A90	-4	-16	-34	1	15	20
Z4651D60	-9	-14	-12	-8	16	22
Z4652D65	-4	-13	4	5	1	2
Z4653D60	-11	-6	-10	11	9	13
N4115A75	-12	-2	-18	-27	15	26
N4180A80	-10	-8	-24	-34	17	29
N4181A80	-17	-10	-50	-44	38	55
N4121A90	-18	-17	-32	-32	12	20
N4008A80	-15	-	-35	-46	41	68
N0304A75	-20	-30	-70	-54	9	18
N4257A85	-19	-32	-39	-33	21	31
N4274A85	-20	-42	-37	-12	26	39
N4263A90	-16	-52	-21	29	23	36
KB162A80	-12	-	-49	-40	20	30
KB163A90	-22	-	-38	-22	18	28
N4007A95	-18	-	-17	-31	29	44
E4183A80	-23	-23	-64	-53	77	112
E4207A90	-5	5	0	-4	-1	-1
E4259A80	-7	-8	-15	-7	18	26
E4270A90	-16	-	-52	-38	26	38
V4205A75	-3	12	-8	-7	1	2
V4208A90	-5	-3	-18	-13	2	5
V4266A95	-2	-6	-4	-7	2	4
V4276A85	-19	-58	-56	-12	16	33

	Points Change Hardness	Percent Change				
		100% Modulus (PSI)	Tensile Strength (PSI)	Elongation (%)	Weight	Volume
<b>Stauffer 7700</b>						
P4300A90	-1	-3	23	-10	9	10
P4301A90	-2	-9	-14	0	11	14
P4304D60	2	-3	6	8	5	6
P4311A90	-2	-2	-1	0	9	11
P4500A90	-3	-6	15	-4	9	11
P6000A90	-3	0	14	9	7	9
Z4651D60	-1	-6	6	-2	8	9
Z4652D65	-3	1	8	9	5	6
Z4653D60	-5	4	7	31	6	8
N4115A75	-9	16	3	-24	18	25
N4180A80	-17	-5	6	-14	18	26
N4181A80	-16	-10	-26	-24	31	37
N4121A90	-14	0	5	-13	15	22
N4008A80	-13	15	-25	-36	32	43
N0304A75	-18	19	-48	-45	31	42
N4257A85	-1	45	8	-36	8	10
N4274A85	-5	26	21	-4	9	11
N4263A90	-3	-2	11	-3	12	16
KB162A80	-6	-7	-16	-13	13	17
KB163A90	-9	-3	-7	-2	10	14
N4007A95	-21	1	-9	-15	14	18
E4183A80	-17	-18	-20	-19	22	27
E4207A90	-14	-	-40	-28	16	20
E4259A80	-16	10	-35	-25	24	28
E4270A90	-10	-	-16	-5	17	20
V4205A75	-7	-7	-22	-10	6	11
V4208A90	-10	-11	-25	-15	6	11
V4266A95	-3	-10	-11	1	4	8
V4276A85	-5	-41	-24	7	7	11



# Chemical Compatibility



	Points Change Hardness	Percent Change				
		100% Modulus (PSI)	Tensile Strength (PSI)	Elongation (%)	Weight	Volume
<b>Methanol</b>						
P4300A90	-3	-25	-16	-17	12	18
P4301A90	-1	-35	-23	7	10	14
P4304D60	-13	-32	-25	-3	11	15
P4311A90	-3	-20	-19	6	12	17
P4500A90	-4	-29	-52	-8	9	13
P6000A90	-5	-28	-46	3	8	12
Z4651D60	-5	-16	-5	-4	7	11
Z4652D65	-3	-18	-7	7	-1	-1
Z4653D60	-5	-4	-3	19	4	5
N4115A75	-1	2	-10	-14	-2	-1
N4180A80	0	-12	-9	-17	2	4
N4181A80	-4	-12	-27	-24	7	11
N4121A90	-6	-16	-18	-14	2	5
N4008A80	0	-1	-8	-5	-3	-3
N0304A75	-3	-9	-21	-13	-3	-2
N4257A85	-16	-37	-34	-22	6	10
N4274A85	-19	-57	-40	-1	8	13
N4263A90	-12	-52	-24	-44	15	33
KB162A80	-7	-12	-30	-23	6	9
KB163A90	-9	-21	-26	-7	5	8
N4007A95	-2	0	-17	8	5	9
E4183A80	0	0	-2	-3	0	0
E4207A90	-2	3	4	3	-1	-1
E4259A80	n/a	n/a	n/a	n/a	n/a	n/a
E4270A90	-16	-8	-7	0	1	1
V4205A75	0	-17	-16	0	6	13
V4208A90	-24	-26	-58	-41	23	53
V4266A95	-13	-	-44	-32	15	33
V4276A85	4	-8	-7	15	1	1

	Points Change Hardness	Percent Change				
		100% Modulus (PSI)	Tensile Strength (PSI)	Elongation (%)	Weight	Volume
<b>Rando HD 32</b>						
P4300A90	0	0	17	3	2	2
P4301A90	0	-1	1	-4	2	3
P4304D60	2	-2	13	9	1	2
P4311A90	-1	2	15	7	2	2
P4500A90	-2	3	43	4	1	1
P6000A90	-2	2	12	10	1	2
Z4651D60	2	-2	12	0	2	3
Z4652D65	-1	4	5	0	1	2
Z4653D60	-3	6	-1	21	2	4
N4115A75	9	66	10	-30	-5	-5
N4180A80	-3	19	12	-19	0	0
N4181A80	-3	10	-7	-17	5	6
N4121A90	0	23	0	-27	0	1
N4008A80	-1	22	-9	-28	3	5
N0304A75	7	55	0	-34	-3	-2
N4257A85	3	113	24	-33	-3	-4
N4274A85	2	45	23	5	-1	-2
N4263A90	3	33	25	-19	-1	-1
KB162A80	1	3	3	1	2	3
KB163A90	-2	9	7	4	2	2
N4007A95	1	7	0	-8	1	2
E4183A80	-25	13	-51	-49	76	106
E4207A90	-22	-	-60	-48	56	79
E4259A80	-24	-	-68	-57	86	106
E4270A90	-16	-	-48	-40	57	74
V4205A75	-1	6	-8	-10	0	0
V4208A90	-3	-2	-14	-12	1	2
V4266A95	0	-1	3	4	1	2
V4276A85	2	-20	-15	-15	2	3



**Chemical Compatibility**

	Points Change Hardness	Percent Change				
		100% Modulus (PSI)	Tensile Strength (PSI)	Elongation (%)	Weight	Volume
<b>JP-4 Jet Fuel</b>						
P4300A90	0	-3	5	-8	8	11
P4301A90	0	-13	-5	9	9	12
P4304D60	-2	-7	0	1	4	5
P4311A90	-1	-4	-9	4	7	10
P4500A90	-2	-91	-92	-7	6	9
P6000A90	-3	-6	-14	0	4	5
Z4651D60	-3	-9	-1	-5	7	11
Z4652D65	2	-3	9	8	1	1
Z4653D60	-4	-3	2	31	4	7
N4115A75	-7	-2	-15	-20	3	8
N4180A80	0	-9	-5	-6	6	11
N4181A80	-10	-12	-26	-19	14	22
N4121A90	-11	-9	-10	-10	11	16
N4008A80	-10	3	-30	-35	14	26
N0304A75	-11	-8	-30	-23	4	10
N4257A85	-8	-26	-25	-19	7	11
N4274A85	-13	-36	-17	8	8	12
N4263A90	-6	-39	-8	37	7	12
KB162A80	-11	-2	-16	-17	5	7
KB163A90	-15	-18	-23	-7	5	8
N4007A95	-7	-3	-14	-8	9	15
E4183A80	-22	-	-72	-62	84	134
E4207A90	-7	11	7	-5	8	12
E4259A80	-17	6	-49	-33	57	74
E4270A90	-18	-	-63	-51	-	-
V4205A75	1	1	8	0	0	0
V4208A90	-4	-1	-16	-11	1	2
V4266A95	-1	-3	8	2	1	2
V4276A85	-6	-52	-42	24	8	15

	Points Change Hardness	Percent Change				
		100% Modulus (PSI)	Tensile Strength (PSI)	Elongation (%)	Weight	Volume
<b>EAL 224 Rapeseed Oil</b>						
P4300A90	-1	-2	16	-1	2	2
P4301A90	0	-3	1	4	2	3
P4304D60	3	-4	6	7	2	2
P4311A90	-2	2	-11	16	3	3
P4500A90	-1	-2	5	12	2	2
P6000A90	-2	3	-10	13	1	2
Z4651D60	2	-1	-8	-1	2	3
Z4652D65	-1	3	6	4	2	2
Z4653D60	-4	5	3	23	3	4
N4115A75	-1	20	12	-12	1	3
N4180A80	-7	3	9	-5	0	1
N4181A80	-7	-7	-6	-3	11	14
N4121A90	-4	9	3	-10	2	5
N4008A80	-7	4	-22	-27	10	16
N0304A75	-6	7	-3	-18	1	6
N4257A85	5	69	9	-27	-3	-4
N4274A85	2	4	16	31	-2	-2
N4263A90	3	15	15	10	-1	-1
KB162A80	-2	-1	6	6	8	11
KB163A90	-6	-4	-2	5	8	10
N4007A95	-3	-2	4	15	1	2
E4183A80	-20	-18	-30	-28	26	35
E4207A90	-16	-	-41	-22	19	27
E4259A80	-19	-5	-41	-23	28	35
E4270A90	-11	-7	-17	-9	18	22
V4205A75	-1	3	-8	-7	0	0
V4208A90	-3	0	-12	-6	1	2
V4266A95	0	-1	1	9	1	1
V4276A85	5	-15	-5	34	1	1



# Chemical Compatibility



	Points Change Hardness	Percent Change				
		100% Modulus (PSI)	Tensile Strength (PSI)	Elongation (%)	Weight	Volume
<b>JA Jet Fuel</b>						
P4300A90	1	-3	19	-7	6	8
P4301A90	0	-10	2	9	5	7
P4304D60	0	-5	2	-1	2	3
P4311A90	-2	-5	2	10	5	7
P4500A90	-2	-10	-17	-6	4	6
P6000A90	-2	-7	3	4	3	4
Z4651D60	-1	-8	12	0	5	7
Z4652D65	4	-3	12	7	0	1
Z4653D60	-4	-2	3	30	3	4
N4115A75	4	-3	-13	-17	5	8
N4180A80	-3	-11	-3	-7	4	6
N4181A80	-8	-14	-17	-11	10	15
N4121A90	-6	-3	-13	-19	5	13
N4008A80	-8	0	-22	-25	13	22
N0304A75	-11	-13	-24	-18	7	13
N4257A85	-3	-3	-8	-10	2	3
N4274A85	-1	-12	2	13	3	5
N4263A90	-2	-22	-1	27	4	5
KB162A80	-1	7	-9	-11	3	4
KB163A90	-3	-13	-9	10	4	5
N4007A95	0	12	-1	8	4	5
E4183A80	-22	-	-72	-66	93	141
E4207A90	-7	-	-52	-41	39	60
E4259A80	-23	-	-70	-60	109	131
E4270A90	-15	-	-63	-59	-	-
V4205A75	-1	5	-9	-8	0	1
V4208A90	-6	0	-12	-8	1	2
V4266A95	-1	-4	9	13	1	2
V4276A85	2	-9	-5	12	1	2

	Points Change Hardness	Percent Change				
		100% Modulus (PSI)	Tensile Strength (PSI)	Elongation (%)	Weight	Volume
<b>Ethylene Glycol 97%</b>						
P4300A90	-2	-16	-30	-6	5	5
P4301A90	-1	-19	-32	9	3	4
P4304D60	-1	-17	-38	7	5	5
P4311A90	-3	-8	-52	18	6	6
P4500A90	-4	-16	-47	20	5	5
P6000A90	-2	-16	-59	12	5	6
Z4651D60	-1	-8	-5	1	3	3
Z4652D65	-2	-7	-21	8	3	3
Z4653D60	-4	2	-37	-14	1	1
N4115A75	3	36	4	-24	0	1
N4180A80	-1	15	9	-14	-1	-1
N4181A80	-2	18	-4	-15	6	7
N4121A90	1	8	-2	-18	-2	-2
N4008A80	3	12	-10	-24	-2	-2
N0304A75	1	37	-8	-26	-4	-4
N4257A85	0	34	-9	-37	4	3
N4274A85	-2	8	7	10	7	7
N4263A90	3	4	6	3	2	3
KB162A80	1	4	5	3	3	3
KB163A90	0	-3	-2	4	3	3
N4007A95	-2	8	4	0	2	2
E4183A80	0	-3	-11	-11	-1	-1
E4207A90	-2	-2	8	5	-1	-1
E4259A80	-2	-2	5	3	1	1
E4270A90	-2	4	15	13	1	1
V4205A75	-3	-5	-20	1	1	1
V4208A90	-3	-10	-27	-5	2	3
V4266A95	-1	-21	-20	10	1	2
V4276A85	4	-13	-7	30	2	1



**Chemical Compatibility**

	Points Change Hardness	Percent Change				
		100% Modulus (PSI)	Tensile Strength (PSI)	Elongation (%)	Weight	Volume
<b>ASTM Oil #1</b>						
P4300A90	1	-2	-4	-1	0	1
P4301A90	0	-2	3	8	0	1
P4304D60	-1	0	3	4	0	0
P4311A90	-1	3	11	3	0	0
P4500A90	-1	-1	31	3	0	0
P6000A90	-2	7	29	9	0	1
Z4651D60	4	2	6	1	0	0
Z4652D65	1	6	1	2	0	0
Z4653D60	-5	4	-2	28	1	1
N4115A75	12	88	16	-30	-7	-9
N4180A80	-3	26	14	-15	-3	-3
N4181A80	0	30	0	-22	1	1
N4121A90	0	13	4	-17	-3	-3
N4008A80	5	15	-25	-36	-5	-5
N0304A75	11	72	4	-27	-7	-9
N4257A85	5	102	18	-28	-5	-7
N4274A85	2	53	22	4	-4	-5
N4263A90	5	35	20	-29	-3	-4
KB162A80	2	2	-12	-15	0	-1
KB163A90	-1	6	4	2	0	-1
N4007A95	-2	5	-4	-15	-1	-1
E4183A80	-24	1	-40	-39	65	88
E4207A90	-18	-	-38	-32	43	60
E4259A80	-22	-	-56	-47	67	84
E4270A90	-17	-	-26	-26	45	58
V4205A75	-3	3	-1	-7	0	0
V4208A90	-3	-2	-17	-11	1	2
V4266A95	0	-4	1	7	1	2
V4276A85	5	-6	2	26	1	1

	Points Change Hardness	Percent Change				
		100% Modulus (PSI)	Tensile Strength (PSI)	Elongation (%)	Weight	Volume
<b>Distilled Water</b>						
P4300A90	-1	-14	-3	3	1	1
P4301A90	-1	-18	-26	14	1	1
P4304D60	-5	-18	-28	16	2	2
P4311A90	-2	0	-31	19	0	1
P4500A90	-5	-19	-49	38	1	2
P6000A90	-2	-17	-65	9	1	2
Z4651D60	-3	-9	2	1	1	1
Z4652D65	2	2	-1	2	0	0
Z4653D60	-5	0	-26	-10	1	1
N4115A75	2	24	3	-28	3	3
N4180A80	-1	14	6	-24	1	2
N4181A80	-7	11	-4	-14	9	11
N4121A90	1	19	2	-24	1	1
N4008A80	0	19	-8	-19	1	1
N0304A75	4	35	-5	-23	1	1
N4257A85	-2	3	-9	-21	8	9
N4274A85	-7	-13	-6	-1	13	15
N4263A90	-2	-9	6	21	4	4
KB162A80	3	11	5	-1	1	1
KB163A90	-3	0	4	4	1	1
N4007A95	-2	4	1	15	2	1
E4183A80	-3	-4	-14	-14	0	-1
E4207A90	-2	4	3	-2	1	0
E4259A80	-3	0	14	8	1	1
E4270A90	-3	2	23	26	1	0
V4205A75	-1	3	-8	0	2	3
V4208A90	-6	-5	15	7	3	4
V4266A95	-3	-15	16	11	1	2
V4276A85	-3	-21	1	28	5	6



# Chemical Compatibility



	Points Change Hardness	Percent Change				
		100% Modulus (PSI)	Tensile Strength (PSI)	Elongation (%)	Weight	Volume
<b>IRM Oil 903</b>						
P4300A90	-1	-6	-28	-10	8	9
P4301A90	-2	-8	0	14	9	12
P4304D60	-1	-1	11	8	5	6
P4311A90	-2	-1	19	0	6	7
P4500A90	-3	-4	19	-1	6	7
P6000A90	-2	0	40	15	5	6
Z4651D60	0	-2	13	0	8	10
Z4652D65	-4	4	10	7	5	7
Z4653D60	-7	4	7	26	6	8
N4115A75	-1	26	5	-21	3	4
N4180A80	-13	-2	10	-14	8	11
N4181A80	-10	-2	-9	-13	15	19
N4121A90	-5	8	1	-10	5	8
N4008A80	-12	11	-12	-23	18	26
N0304A75	-6	24	1	-23	7	11
N4257A85	1	50	11	-16	5	6
N4274A85	0	15	18	2	7	8
N4263A90	0	2	14	8	7	9
KB162A80	-4	-3	-11	-10	8	10
KB163A90	-6	-2	-4	-1	7	9
N4007A95	-10	-6	2	-8	10	14
E4183A80	-24	-	-62	-55	93	122
E4207A90	-21	-	-60	-55	68	91
E4259A80	-22	-	-71	-57	107	128
E4270A90	-16	-	-43	-44	70	85
V4205A75	-3	3	-15	-10	1	1
V4208A90	-3	-3	-17	-11	1	3
V4266A95	0	-7	-6	6	1	1
V4276A85	-1	-41	-20	31	4	11

	Points Change Hardness	Percent Change				
		100% Modulus (PSI)	Tensile Strength (PSI)	Elongation (%)	Weight	Volume
<b>Oven Air Aged</b>						
P4300A90	0	2	21	-3	0	-
P4301A90	0	1	2	-1	0	-
P4304D60	-2	0	5	3	0	0
P4311A90	-1	3	2	-1	0	0
P4500A90	-3	0	6	-5	0	0
P6000A90	-1	6	10	2	0	0
Z4651D60	0	2	10	-1	0	-
Z4652D65	4	4	3	2	0	0
Z4653D60	-2	3	-2	21	0	1
N4115A75	11	101	6	-44	-3	-4
N4180A80	5	59	14	-34	-2	-2
N4181A80	5	148	-43	-72	-1	-2
N4121A90	4	52	17	-33	-2	-3
N4008A80	13	44	11	-19	-3	-4
N0304A75	11	98	-1	-40	-4	-6
N4257A85	6	103	36	-23	-5	-7
N4274A85	3	89	29	-25	-4	-5
N4263A90	5	-	37	-44	-4	-6
KB162A80	4	15	5	-1	0	0
KB163A90	0	13	-9	-18	-1	-1
N4007A95	1	12	2	8	-2	-
E4183A80	1	3	-16	-17	-2	-3
E4207A90	0	-6	-11	-5	-1	-2
E4259A80	0	4	7	4	-1	-1
E4270A90	-6	9	8	-4	0	0
V4205A75	1	9	17	-3	0	0
V4208A90	-2	0	-9	-7	1	1
V4266A95	0	3	14	7	0	1
V4276A85	4	7	10	3	0	-1



## N4115A75

Grade	Suffix Requirements (Tests)											
	A14	A24	B14	B34	EA14	EF11	EF21	EO14	EO34	F16	F17	F19
2	Passes	Not Tested	Passes	Passes	Passes	Passes	Passes	Passes	Passes	Not Tested	Passes	Passes
3	Not Tested	Not Tested	Passes	Passes	Not Tested	Not Tested	Not Tested	Passes	Passes	Not Tested	Not Tested	Passes
4	Passes	Passes	Passes	Passes	Not Tested	Passes	Passes	Passes	Passes	Not Tested	Not Tested	Passes
5	Passes	Not Tested	Passes	Passes	Not Tested	Not Tested	Not Tested	Passes	Passes	Not Tested	Not Tested	Passes
6	Passes	Not Tested	Passes	Passes	Not Tested	Not Tested	Not Tested	Passes	Passes	Not Tested	Passes	Not Tested
7	Not Tested	Not Tested	Passes	Not Tested	Passes	Passes	Passes	Passes	Passes	Passes	Not Tested	Not Tested

ASTM Call-Out: Grade (BF, BG, BK, CH) 822 (Tests per Grade as shown above, such as A14 for grades 2-6)

## N4180A80

Grade	Suffix Requirements (Tests)											
	A14	A24	B14	B34	EA14	EF11	EF21	EO14	EO34	F16	F17	F19
2	Not Tested	Not Tested	Passes	Passes	Passes	Passes	Passes	Passes	Passes	Not Tested	Passes	Passes
3	Not Tested	Not Tested	Passes	Passes	Not Tested	Not Tested	Not Tested	Passes	Passes	Not Tested	Not Tested	Passes
4	Not Tested	Passes	Passes	Passes	Not Tested	Passes	Passes	Passes	Passes	Not Tested	Not Tested	Passes
5	Passes	Not Tested	Passes	Passes	Not Tested	Not Tested	Not Tested	Passes	Passes	Not Tested	Not Tested	Passes
6	Passes	Not Tested	Passes	Passes	Not Tested	Not Tested	Not Tested	Passes	Passes	Not Tested	Passes	Not Tested
7	Not Tested	Not Tested	Passes	Not Tested	Passes	Passes	Passes	Passes	Passes	Passes	Not Tested	Not Tested

ASTM Call-Out: Grade (BF, BG, BK, CH) 820 (Tests per Grade as shown above, such as A14 for grades 2-6)

## N4181AA80

Grade	Suffix Requirements (Tests)											
	A14	A24	B14	B34	EA14	EF11	EF21	EO14	EO34	F16	F17	F19
2	Not Tested	Not Tested	Passes	Passes	Volume	Passes	Not Tested	Passes	Passes	Not Tested	Passes	Passes
3	Not Tested	Not Tested	Passes	Passes	Volume	Not Tested	Not Tested	Passes	Passes	Not Tested	Not Tested	Passes
4	Passes	Passes	Passes	Passes	Not Tested	Passes	Not Tested	Not BK	Passes	Not Tested	Not Tested	Passes
5	Passes	Not Tested	Passes	Passes	Not Tested	Not Tested	Not Tested	Passes	Passes	Not Tested	Not Tested	Passes
6	Passes	Not Tested	Passes	Passes	Not Tested	Not Tested	Not Tested	Passes	Passes	Not Tested	Passes	Not Tested
7	Not Tested	Not Tested	Passes	Not Tested	Not Tested	Passes	Passes	Passes	Passes	Passes	Not Tested	Not Tested

ASTM Call-Out: Grade (BF, BG, BK, CH) 826 (Tests per Grade as shown above, such as A14 for grades 2-6)

## N4121A90

Grade	Suffix Requirements (Tests)											
	A14	A24	B14	B34	EA14	EF11	EF21	EO14	EO34	F16	F17	F19
2	Not Tested	Not Tested	Passes	Passes	Passes	Passes	Passes	Passes	Passes	Not Tested	Passes	Passes
3	Not Tested	Not Tested	Passes	Passes	Not Tested	Not Tested	Not Tested	Passes	Not Tested	Not Tested	Not Tested	Passes
4	Passes	Passes	Passes	Passes	Not Tested	Passes	Passes	Passes	Not Tested	Not Tested	Not Tested	Passes
5	Passes	Not Tested	Passes	Passes	Not Tested	Not Tested	Not Tested	Passes	Passes	Not Tested	Not Tested	Passes
6	Passes	Not Tested	Passes	Passes	Not Tested	Not Tested	Not Tested	Passes	Passes	Not Tested	Passes	Not Tested
7	Not Tested	Not Tested	Passes	Not Tested	Passes	Passes	Passes	Passes	Passes	Passes	Not Tested	Not Tested

ASTM Call-Out: Grade (BF, BG, BK, CH) 9 (21 or less) (Tests per Grade as shown above, such as A14 for grades 2-6)

**Key:**

Passes 
 Not Tested 
 Fails 
 Not Required 

09/01/07





**N4008A80**

Grade	Suffix Requirements (Tests)											
	A14	A24	B14	B34	EA14	EF11	EF21	EO14	EO34	F16	F17	F19
2												
3												
4												
5												
6												
7												

ASTM Call-Out: Grade (BF, BG, BK, CH) 826 (Tests per Grade as shown above, such as A14 for grades 2-6)

**N0304A75**

Grade	Suffix Requirements (Tests)											
	A14	A24	B14	B34	EA14	EF11	EF21	EO14	EO34	F16	F17	F19
2												
3												
4												
5												
6												
7												

ASTM Call-Out: Grade (BF, BG, BK, CH) 8 (21 or less) (Tests per Grade as shown above, such as A14 for grades 2-6)

**N4257A85**

Grade	Suffix Requirements (Tests)											
	A14	A24	B14	B34	EA14	EF11	EF21	EO14	EO34	F16	F17	F19
2												
3												
4								BK Only				
5												
6												
7												

ASTM Call-Out: Grade (BF, BG, BK, CH) 830 (Tests per Grade as shown above, such as A14 for grades 2-6)

**N4274A85**

Grade	Suffix Requirements (Tests)											
	A14	A24	B14	B34	EA14	EF11	EF21	EO14	EO34	F16	F17	F19
2												
3												
4												
5												
6												
7												

ASTM Call-Out: Grade (BF, BG, BK, CH) 831 (Tests per Grade as shown above, such as A14 for grades 2-6)

**Key:**

Passes 
     
 Not Tested 
     
 Fails 
     
 Not Required 

**N4263A90**

Grade	Suffix Requirements (Tests)											
	A14	A24	B14	B34	EA14	EF11	EF21	EO14	EO34	F16	F17	F19
2												
3												
4												
5												
6												
7												

ASTM Call-Out: Grade (BF, BG, BK, CH) 932 (Tests per Grade as shown above, such as A14 for grades 2-6)

**KB162A80**

Grade	Suffix Requirements (Tests)											
	A14	A24	B14	B34	EA14	EF11	EF21	EO14	EO34	F16	F17	F19
2												
3												
4												
5												
6												
7												

ASTM Call-Out: Grade (BF, BG, BK, CH) 8 (21 or less) (Tests per Grade as shown above, such as A14 for grades 2-6)

**KB163A90**

Grade	Suffix Requirements (Tests)											
	A14	A24	B14	B34	EA14	EF11	EF21	EO14	EO34	F16	F17	F19
2												
3												
4												
5												
6												
7												

ASTM Call-Out: Grade (BF, BG, BK, CH) 8 (21 or less) (Tests per Grade as shown above, such as A14 for grades 2-6)

**N4007A95**

Grade	Suffix Requirements (Tests)											
	A14	A24	B14	B34	EA14	EF11	EF21	EO14	EO34	F16	F17	F19
2												
3												
4												
5												
6												
7												

ASTM Call-Out: Grade (BF, BG, BK, CH) 940 (Tests per Grade as shown above, such as A14 for grades 2-6)

**Key:**

Passes		Not Tested		Fails		Not Required	
--------	---	------------	---	-------	---	--------------	---



**V4205A75**

Grade	Suffix Requirements (Tests)										
	A1-10	A1-11	B31	B37	B38	C12	C20	EF31	EO88	F15	F17
2	Not Tested			Not Tested	Passes	Not Tested	Not Tested	Passes		Not Tested	
3	Not Tested			Not Tested	Passes	Not Tested	Not Tested	Passes			
4		Not Tested			Passes	Not Tested	Not Tested	Passes		Not Tested	Not Tested
5		Not Tested			Passes	Not Tested	Not Tested	Passes		Not Tested	
6	Not Tested	Not Tested	Not Tested		Not Tested	Not Tested	Not Tested	Passes	Passes		
7	Not Tested	Not Tested	Not Tested		Passes	Not Tested	Not Tested	Passes	Passes		

ASTM Call-Out: Grade HK 720 (Tests per Grade as shown above, such as A14 for grades 2-6 )

**V4208A90**

Grade	Suffix Requirements (Tests)										
	A1-10	A1-11	B31	B37	B38	C12	C20	EF31	EO88	F15	F17
2	Not Tested			Not Tested	Passes	Not Tested	Not Tested	Passes		Not Tested	
3	Not Tested			Not Tested	Passes	Not Tested	Not Tested	Passes			
4		Not Tested			Passes	Not Tested	Not Tested	Passes		Not Tested	Not Tested
5		Not Tested			Passes	Not Tested	Not Tested	Passes		Not Tested	
6	Not Tested	Not Tested	Not Tested		Not Tested	Not Tested	Not Tested	Passes	Passes		
7	Not Tested	Not Tested	Not Tested		Passes	Not Tested	Not Tested	Passes	Passes		

ASTM Call-Out: Grade HK 918 (Tests per Grade as shown above, such as A14 for grades 2-6 )

**V4266A95**

Grade	Suffix Requirements (Tests)										
	A1-10	A1-11	B31	B37	B38	C12	C20	EF31	EO88	F15	F17
2	Not Tested			Not Tested	Passes	Not Tested	Not Tested	Passes		Not Tested	
3	Not Tested			Not Tested	Passes	Not Tested	Not Tested	Passes			
4		Not Tested			Passes	Not Tested	Not Tested	Passes		Not Tested	Not Tested
5		Not Tested			Passes	Not Tested	Not Tested	Passes		Not Tested	
6	Not Tested	Not Tested	Not Tested		Not Tested	Not Tested	Not Tested	Passes	Passes		
7	Not Tested	Not Tested	Not Tested		Passes	Not Tested	Not Tested	Passes	Passes		

ASTM Call-Out: Grade HK 920 (Tests per Grade as shown above, such as A14 for grades 2-6 )

**E4183A80**

Grade	Suffix Requirements (Tests)											
	A25	B44	B35	EA14	F17	F18	F19	G11	G21	K11	P2	R11
2	Not Tested	Passes	Passes	Passes	Not Tested	Not Tested		Not Tested	Not Tested		Not Tested	Not Tested
3	Not Tested	Passes	Passes	Passes	Not Tested	Not Tested		Not Tested	Not Tested		Not Tested	Not Tested
4	Not Tested		Passes	Passes	Not Tested	Not Tested		Not Tested	Not Tested		Not Tested	Not Tested
5	Not Tested		Passes	Passes	Not Tested	Not Tested	Not Tested	Not Tested	Not Tested		Not Tested	Not Tested
6	Not Tested		Passes	Passes	Not Tested			Not Tested	Not Tested		Not Tested	Not Tested
7	Not Tested		Passes	Passes	Not Tested	Not Tested		Not Tested	Not Tested		Not Tested	Not Tested
8	Not Tested		Passes	Passes	Not Tested			Not Tested	Not Tested		Not Tested	Not Tested

ASTM Call-Out: Grade CA 822 (Tests per Grade as shown above, such as A14 for grades 2-6 )

**Key:**

Passes  Not Tested  Fails  Not Required 

**E4207A90**

Grade	Suffix Requirements (Tests)											
	A25	B44	B35	EA14	F17	F18	F19	G11	G21	K11	P2	R11
2	Not Tested	Passes	Passes	Passes	Not Tested	Not Tested	Not Required	Not Tested	Not Tested	Not Required	Not Tested	Not Tested
3	Not Tested	Passes	Passes	Passes	Not Tested	Not Tested	Not Required	Not Tested	Not Tested	Not Required	Not Tested	Not Tested
4	Not Tested	Not Tested	Passes	Passes	Not Tested	Not Tested	Not Required	Not Tested	Not Tested	Not Required	Not Tested	Not Tested
5	Not Tested	Not Tested	Passes	Passes	Not Tested	Not Tested	Not Tested	Not Tested	Not Tested	Not Required	Not Tested	Not Tested
6	Not Tested	Not Tested	Passes	Passes	Not Tested	Not Tested	Not Tested	Not Tested	Not Tested	Not Required	Not Tested	Not Tested
7	Not Tested	Not Tested	Passes	Passes	Not Tested	Not Tested	Not Tested	Not Tested	Not Tested	Not Required	Not Tested	Not Tested
8	Not Tested	Not Tested	Passes	Passes	Not Tested	Not Tested	Not Tested	Not Tested	Not Tested	Not Required	Not Tested	Not Tested

ASTM Call-Out: Grade CA 920 (Tests per Grade as shown above, such as A14 for grades 2-6 )

**E4259A80**

Grade	Suffix Requirements (Tests)											
	A25	B44	B35	EA14	F17	F18	F19	G11	G21	K11	P2	R11
2	Not Tested	Passes	Passes	Passes	Not Tested	Not Tested	Not Required	Not Tested	Not Tested	Not Required	Not Tested	Not Tested
3	Not Tested	Passes	Passes	Passes	Not Tested	Not Tested	Not Required	Not Tested	Not Tested	Not Required	Not Tested	Not Tested
4	Not Tested	Not Tested	Passes	Passes	Not Tested	Not Tested	Not Required	Not Tested	Not Tested	Not Required	Not Tested	Not Tested
5	Not Tested	Not Tested	Passes	Passes	Not Tested	Not Tested	Not Tested	Not Tested	Not Tested	Not Required	Not Tested	Not Tested
6	Not Tested	Not Tested	Passes	Passes	Not Tested	Not Tested	Not Tested	Not Tested	Not Tested	Not Required	Not Tested	Not Tested
7	Not Tested	Not Tested	Passes	Passes	Not Tested	Not Tested	Not Tested	Not Tested	Not Tested	Not Required	Not Tested	Not Tested
8	Not Tested	Not Tested	Passes	Passes	Not Tested	Not Tested	Not Tested	Not Tested	Not Tested	Not Required	Not Tested	Not Tested

ASTM Call-Out: Grade CA 822 (Tests per Grade as shown above, such as A14 for grades 2-6 )

**E4270A90**

Grade	Suffix Requirements (Tests)											
	A25	B44	B35	EA14	F17	F18	F19	G11	G21	K11	P2	R11
2	Not Tested	Passes	Not Tested	Passes	Not Tested	Not Tested	Not Required	Not Tested	Not Tested	Not Required	Not Tested	Not Tested
3	Not Tested	Passes	Not Tested	Passes	Not Tested	Not Tested	Not Required	Not Tested	Not Tested	Not Required	Not Tested	Not Tested
4	Not Tested	Not Tested	Not Tested	Passes	Not Tested	Not Tested	Not Required	Not Tested	Not Tested	Not Required	Not Tested	Not Tested
5	Not Tested	Not Tested	Not Tested	Passes	Not Tested	Not Tested	Not Tested	Not Tested	Not Tested	Not Required	Not Tested	Not Tested
6	Not Tested	Not Tested	Not Tested	Passes	Not Tested	Not Tested	Not Tested	Not Tested	Not Tested	Not Required	Not Tested	Not Tested
7	Not Tested	Not Tested	Not Tested	Passes	Not Tested	Not Tested	Not Tested	Not Tested	Not Tested	Not Required	Not Tested	Not Tested
8	Not Tested	Not Tested	Not Tested	Passes	Not Tested	Not Tested	Not Tested	Not Tested	Not Tested	Not Required	Not Tested	Not Tested

ASTM Call-Out: Grade CA 926 (Tests per Grade as shown above, such as A14 for grades 2-6 )

**Key:**

Passes 
     
 Not Tested 
     
 Fails 
     
 Not Required 



## Metric Tolerances used for Seal Hardware (per ISO 286-2:1988)

Basic Size mm		H8	H9	H11	f7	f8	h8	h9	h10
Above	Up To and Including	mm							
-	3	+0.014 0	+0.025 0	+0.060 0	-0.006 -0.016	-0.006 -0.020	0 -0.014	0 -0.025	0 -0.040
3	6	+0.018 0	+0.030 0	+0.075 0	-0.010 -0.022	-0.010 -0.028	0 -0.018	0 -0.030	0 -0.048
6	10	+0.022 0	+0.036 0	+0.090 0	-0.013 -0.028	-0.013 -0.035	0 -0.022	0 -0.036	0 -0.058
10	18	+0.027 0	+0.043 0	+0.110 0	-0.016 -0.034	-0.016 -0.043	0 -0.027	0 -0.043	0 -0.070
18	30	+0.033 0	+0.052 0	+0.130 0	-0.020 -0.041	-0.020 -0.053	0 -0.033	0 -0.052	0 -0.084
30	50	+0.039 0	+0.062 0	+0.160 0	-0.025 -0.050	-0.025 -0.064	0 -0.039	0 -0.062	0 -0.100
50	80	+0.046 0	+0.074 0	+0.190 0	-0.030 -0.060	-0.030 -0.076	0 -0.046	0 -0.074	0 -0.120
80	120	+0.054 0	+0.087 0	+0.220 0	-0.036 -0.071	-0.036 -0.090	0 -0.054	0 -0.087	0 -0.140
120	180	+0.063 0	+0.100 0	+0.250 0	-0.043 -0.083	-0.043 -0.106	0 -0.063	0 -0.100	0 -0.160
180	250	+0.072 0	+0.115 0	+0.290 0	-0.050 -0.096	-0.050 -0.122	0 -0.072	0 -0.115	0 -0.185
250	315	+0.081 0	+0.130 0	+0.320 0	-0.056 -0.108	-0.056 -0.137	0 -0.081	0 -0.130	0 -0.210
315	400	+0.089 0	+0.140 0	+0.360 0	-0.062 -0.119	-0.062 -0.151	0 -0.089	0 -0.140	0 -0.230
400	500	+0.097 0	+0.155 0	+0.400 0	-0.068 -0.131	-0.068 -0.165	0 -0.097	0 -0.155	0 -0.250
500	630	+0.110 0	+0.175 0	+0.440 0	-0.076 -0.146	-0.076 -0.186	0 -0.110	0 -0.175	0 -0.280
630	800	+0.125 0	+0.200 0	+0.500 0	-0.080 -0.160	-0.080 -0.205	0 -0.125	0 -0.200	0 -0.320
800	1000	+0.140 0	+0.230 0	+0.560 0	-0.086 -0.176	-0.086 -0.226	0 -0.140	0 -0.230	0 -0.360
1000	1250	+0.165 0	+0.260 0	+0.660 0	-0.098 -0.203	-0.098 -0.263	0 -0.165	0 -0.260	0 -0.420
1250	1600	+0.195 0	+0.310 0	+0.780 0	-0.110 -0.235	-0.110 -0.305	0 -0.195	0 -0.310	0 -0.500
1600	2000	+0.230 0	+0.370 0	+0.920 0	-0.120 -0.270	-0.120 -0.350	0 -0.230	0 -0.370	0 -0.600
2000	2500	+0.280 0	+0.440 0	+1.100 0	-0.130 -0.305	-0.130 -0.410	0 -0.280	0 -0.440	0 -0.700
2500	3150	+0.330 0	+0.540 0	+1.350 0	-0.145 -0.355	-0.145 -0.475	0 -0.330	0 -0.540	0 -0.860







# Other Parker EPS Products

Catalog EPS 5370/USA

Parker EPS Division designs and manufactures engineered elastomeric, polymeric and plastic seals and sealing systems for dynamic applications. EPS Division has a worldwide sealing network consisting of manufacturing locations in Utah, Texas, New York, Illinois and Baja, Mexico; and more than 200 distributor and service center locations in nine countries.

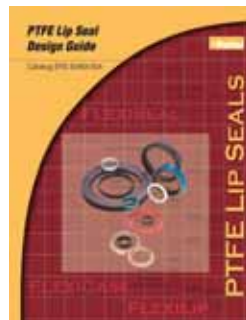

See: *Catalog EPS 5340*

## PTFE Lip Seals

Parker manufactures a wide range of PTFE lip seals to meet the unique temperature, chemical and low friction requirements of high-performance systems. FlexiSeal<sup>®</sup>, FlexiLip<sup>™</sup> and FlexiCase<sup>™</sup> lip seals are available in standard inch, metric and custom designs.

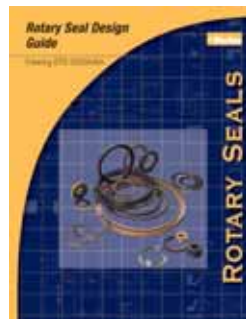

rotary shaft seals available in a multitude of configurations.

See: *Catalog EPS 5350*

## Rotary Shaft Seals

Parker offers a complete line of rotary seal products including the proprietary Clipper<sup>®</sup> Oil Seal design with integrally molded rubber/fiber outer case and elastomeric inner lip. Varying profiles include factory split, MIST, single-lip, dual lip, excluder and molded-in spring. Parker Oil Seals are elastomer-lipped, metal retained

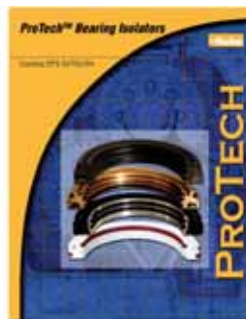

See: *Catalog EPS 5275*

## ProTech Bearing Isolators

ProTech bearing isolators are the ultimate in bearing protection with unitized, two-piece, non-contact design. ProTech provides zero lubricant leakage and total exclusion of contaminants.

G

09/01/07

# Offer of Sale

Catalog EPS 5370/USA

The items described in this document are hereby offered for sale at prices to be established by Parker Hannifin Corporation, its subsidiaries and its authorized distributors. This offer and its acceptance by any customer ("Buyer") shall be governed by all of the following Terms and Conditions. Buyer's order for any item described in this document, when communicated to Parker Hannifin Corporation, its subsidiary or any authorized distributor ("Seller") verbally or in writing, shall constitute acceptance of this offer.

**1. Terms and Conditions of Sale:** All descriptions, quotations, proposals, offers, acknowledgements, acceptances and sales of Seller's products are subject to and shall be governed exclusively by the terms and conditions stated herein. Buyer's acceptance of any offer to sell is limited to these terms and conditions. Any terms or conditions in addition to, or inconsistent with those stated herein, proposed by Buyer in any acceptance of an offer by Seller, are hereby objected to. No such additional, different or inconsistent terms and conditions shall become part of the contract between Buyer and Seller unless expressly accepted in writing by Seller. Seller's acceptance of any offer to purchase by Buyer is expressly conditional upon Buyer's assent to all the terms and conditions stated herein, including any terms in addition to, or inconsistent with those contained in Buyer's offer. Acceptance of Seller's products shall in all events constitute such assent.

**2. Payment:** Payment shall be made by Buyer net 30 days from the date of invoice of the items purchased hereunder. Seller reserves the right to charge interest on all past due amounts. Any claims by Buyer for omissions or shortages in a shipment shall be waived unless Seller receives notice thereof within 30 days after Buyer's receipt of the shipment.

**3. Delivery:** Unless otherwise provided in the face hereof, delivery shall be made F.O.B. Seller's plant. Regardless of the method of delivery, however, risk of loss shall pass to Buyer upon Seller's delivery to a carrier. Any delivery dates shown are approximate only and Seller shall have no liability for any delays in delivery.

**4. Warranty:** Seller warrants that the items sold hereunder shall be free from defects in material or workmanship at the time of delivery. THIS WARRANTY COMPRISES THE SOLE AND ENTIRE WARRANTY PERTAINING TO ITEMS PROVIDED HEREUNDER. SELLER MAKES NO OTHER WARRANTY, GUARANTEE, OR REPRESENTATION OF ANY KIND WHATSOEVER. ALL OTHER WARRANTIES, INCLUDING, BUT NOT LIMITED TO, MERCHANTABILITY AND FITNESS FOR PURPOSE, WHETHER EXPRESS, IMPLIED OR ARISING BY OPERATION OF LAW, TRADE USAGE, OR COURSE OF DEALING ARE HEREBY DISCLAIMED. NOTWITHSTANDING THE FOREGOING, THERE ARE NO WARRANTIES WHATSOEVER ON ITEMS BUILT OR ACQUIRED WHOLLY OR PARTIALLY, TO BUYER'S DESIGNS OR SPECIFICATIONS.

**5. Limitation of Remedy:** SELLER'S LIABILITY ARISING FROM OR IN ANY WAY CONNECTED WITH THE ITEMS SOLD OR THIS CONTRACT SHALL BE LIMITED EXCLUSIVELY TO REPAIR OR REPLACEMENT OF THE ITEMS SOLD OR REFUND OF THE PURCHASE PRICE PAID BY BUYER, AT SELLER'S SOLE OPTION. IN NO EVENT SHALL SELLER BE LIABLE FOR ANY INCIDENTAL, CONSEQUENTIAL OR SPECIAL DAMAGES OF ANY KIND OR NATURE WHATSOEVER, INCLUDING, BUT NOT LIMITED TO LOST PROFITS ARISING FROM OR IN ANY WAY CONNECTED WITH THIS AGREEMENT OR ITEMS SOLD HEREUNDER, WHETHER ALLEGED TO ARISE FROM BREACH OF CONTRACT, EXPRESS OR IMPLIED WARRANTY, OR IN TORT, INCLUDING WITHOUT LIMITATION, NEGLIGENCE, FAILURE TO WARN OR STRICT LIABILITY.

**6. Changes, Reschedules and Cancellations:** Buyer may request to modify the designs or specifications for the items sold hereunder as well as the quantities and delivery dates thereof, or may request to cancel all or part of this order, however, no such requested modification or cancellation shall become part of the contract between Buyer and Seller unless accepted by Seller in a written amendment to this Agreement. Acceptance of any such requested modification or cancellation shall be at Seller's discretion, and shall be upon such terms and conditions as Seller may require.

**7. Special Tooling:** A tooling charge may be imposed for any special tooling, including without limitation, dies, fixtures, molds and patterns, acquired to manufacture items sold pursuant to this contract. Such special tooling shall be and remain Seller's property notwithstanding payment of any charges by Buyer. In no event will Buyer acquire any interest in apparatus belonging to Seller which is utilized in the manufacture of the items sold hereunder, even if such apparatus has been specially converted or adapted for such manufacture and notwithstanding any charges paid by Buyer. Unless otherwise agreed, Seller shall have the right to alter, discard or otherwise dispose of any special tooling or other property in its sole discretion at any time.

**8. Buyer's Property:** Any designs, tools, patterns, materials, drawings, confidential information or equipment furnished by Buyer or any other items which become Buyer's property, may be considered obsolete and may be

destroyed by Seller after two (2) consecutive years have elapsed without Buyer placing an order for the items which are manufactured using such property. Seller shall not be responsible for any loss or damage to such property while it is in Seller's possession or control.

**9. Taxes:** Unless otherwise indicated on the face hereof, all prices and charges are exclusive of excise, sales, use, property, occupational or like taxes which may be imposed by any taxing authority upon the manufacture, sale or delivery of the items sold hereunder. If any such taxes must be paid by Seller or if Seller is liable for the collection of such tax, the amount thereof shall be in addition to the amounts for the items sold. Buyer agrees to pay all such taxes or to reimburse Seller therefor upon receipt of its invoice. If Buyer claims exemption from any sales, use or other tax imposed by any taxing authority, Buyer shall save Seller harmless from and against any such tax, together with any interest or penalties thereon which may be assessed if the items are held to be taxable.

**10. Indemnity for Infringement of Intellectual Property Rights:** Seller shall have no liability for infringement of any patents, trademarks, copyrights, trade dress, trade secrets or similar rights except as provided in this Part 10. Seller will defend and indemnify Buyer against allegations of infringement of U.S. patents, U.S. trademarks, copyrights, trade dress and trade secrets (hereinafter "Intellectual Property Rights"). Seller will defend at its expense and will pay the cost of any settlement or damages awarded in an action brought against Buyer based on an allegation that an item sold pursuant to this contract infringes the Intellectual Property Rights of a third party. Seller's obligation to defend and indemnify Buyer is contingent on Buyer notifying Seller within ten (10) days after the Buyer becomes aware of such allegations of infringement, and Seller having sole control over the defense of any allegations or actions including all negotiations for settlement or compromise. If an item sold hereunder is subject to a claim that it infringes the Intellectual Property Rights of a third party, Seller may, at its sole expense and option, procure for Buyer the right to continue using said item, place or modify said item so as to make it noninfringing, or offer to accept return of said item and return the purchase price less a reasonable allowance for depreciation. Notwithstanding the foregoing, Seller shall have no liability for claims of infringement based on information provided by Buyer, or directed to items delivered hereunder for which the designs are specified in whole or part by Buyer, or infringements resulting from the modification, combination or use in a system of any item sold hereunder. The foregoing provisions of this Part 10 shall constitute Seller's sole and exclusive liability and Buyer's sole and exclusive remedy for infringement of Intellectual Property Rights. If a claim is based on information provided by Buyer or if the design for an item delivered hereunder is specified in whole or in part by Buyer, Buyer shall defend and indemnify Seller for all costs, expenses or judgements resulting from any claim that such item infringes any patent, trademark, copyright, trade dress, trade secret or any similar right.

**11. Force Majeure:** Seller does not assume the risk of and shall not be liable for delay or failure to perform any of Seller's obligations by reason of circumstances beyond the reasonable control of Seller (hereinafter "Events of Force Majeure"). Events of Force Majeure shall include without limitation, accidents, acts of God, strikes or labor disputes, acts, laws, rules or regulations of any government or government agency, fires, floods, delays or failures in delivery of carriers or suppliers, shortages of materials and any other cause beyond Seller's control.

**12.** Any special requirements for items to be provided by Seller hereunder including without limitation; compliance with military specifications, special documentation, or testing requirements, must be communicated to Seller in writing at the time the items are first requested. Any such requests that are communicated to Seller after preparation to manufacture an item has commenced may result in additional charges for rework or remanufacture of the item.

**13. Entire Agreement/Governing Law:** The terms and conditions set forth herein, together with any amendments, modifications and any different terms or conditions expressly accepted by Seller in writing, shall constitute the entire Agreement concerning the items sold, and there are no oral or other representations or agreements which pertain thereto. This Agreement shall be governed in all respects by the law of the State of Ohio. No actions arising out of the sale of the items sold hereunder or this Agreement may be brought by either more than two (2) years after the cause of action accrues.

09/01/07





# Worldwide Fluid Power Sealing

## North America

**EPS Division, Headquarters**  
**Salt Lake City, Utah**  
phone 801 972 3000  
fax 801 973 4019

**EPS Division, Nacogdoches**  
**Nacogdoches, Texas**  
phone 800-233-3900  
fax 936 560 8998

**EPS Division, Marion**  
**Marion, New York**  
phone 315 926 4211  
fax 315 926 4496

**EPS Division, Chicago**  
**Elgin, Illinois**  
phone 847 783 4300  
fax 847 783 4311

**EPS Division, Baja**  
**Baja, Mexico**  
phone 619 671 3257

## Asia Pacific

**China**  
**Parker Hannifin Motion &  
Control (Shanghai) Co., Ltd.**  
phone 86 21 2899 5181  
fax 86 21 5834 8975

## Europe

**Germany**  
**Parker Prädifa**  
phone 49 7142 351 0  
fax 49 7142 351293

**Denmark**  
**Polar Seals ApS**  
phone 45 49 121700  
fax 450490121701

**Belgium**  
**Parker Hannifin,  
Advanced Products, NV**  
phone 32 3 880 81 50  
fax 32 3 888 48 62

---

EPS 5370 AP 5.0M 09/01/07

Parker Hannifin Corporation  
**Engineered Polymer Systems Division**  
2220 South 3600 West  
Salt Lake City, UT 84119  
phone 801 972 3000  
fax 801 973 4019  
[www.parker.com](http://www.parker.com)



Your Local Authorized Parker Distributor